

Gus

Lighting

Glorious Life From

Product Catalog 2023-2024



Flexible strip light
Neon light
Linear light
Intelligent system
Power supply
Controller
Aluminum profile
Accessory

Focus on developing high quality
Linear illumination source system

Contents

01

About Aura

| | |
|--------------------|----|
| Enterprise Profile | 7 |
| Color Consistency | 12 |
| Full Spectrum | 13 |

02

New Product Series

| | |
|--------------------------|----|
| Classic Series (24V/12V) | 16 |
| Module Wall washer | 18 |
| 3D Wall washer | 20 |
| 3D Wall washer | 22 |
| 3D Bending NEON | 24 |
| IP68 NEON | 26 |
| Mini NEON | 28 |
| Weldless COB Series | 30 |
| Spotless lighting | 32 |
| ErP Series | 34 |
| Soft lighting | 36 |
| Ultra-Long Series | 38 |
| S Type Series | 40 |
| High Voltage Series | 42 |
| Haute Color Series | |

03

NEON SERIES

| | |
|-------------------------|-----|
| Top Bending | 46 |
| NEW Side Bending | 54 |
| NEW Mini NEON | 66 |
| IP68 NEON | 80 |
| Mini NEON | 92 |
| IP68 NEON | 98 |
| Long-Run NEON | 104 |
| NEW Beam NEON | 110 |
| 3D Bending NEON | |
| Digital Colorful NEON | |

04

COB Series

| | |
|-----------------------|-----|
| COB Honor (24V / 12V) | 128 |
| COB Essential | 132 |
| COB NEON | 142 |
| COB Connectors | 144 |
| COB IP Rating | 145 |

05

NEW Flexible Wall Washer Series

| | |
|----------------------|-----|
| Module Wall washer | 148 |
| 3D Wall washer | 152 |
| Rainbow Wall washer | 154 |
| Spotless wall washer | 156 |
| Mini wall washer | 160 |

06

LED Strip Series

| | |
|------------------------------|-----|
| Honor Series (24V / 12V) | 166 |
| 2835 / 5050 | |
| Essential Series (24V / 12V) | 176 |
| 2835 / 3528 / 5050 | |
| ErP Series | 186 |
| NEW Spotless Series | 218 |
| 2835 Reel To Reel Series | 228 |
| Ultra-Long Series | 234 |
| NEW Mini LED Series | 260 |
| 2216 Plus / 2110 | |
| Colorful Series | 276 |
| CRI 98+ | 298 |
| CRI 95+ | 300 |

07

Digital Colorful

| | |
|------------|-----|
| SPI Series | 306 |
| DMX Series | 312 |

08

Special Series

| | |
|--|-----|
| NEW Soft lighting 1206 | 322 |
| High voltage Series | 324 |
| 4020 Side Emitting Series | 326 |
| 160° Monolithic Integrated Lens | 328 |
| 12V / 24V Switchable Series | 330 |
| NEW Haute Color Series | 332 |
| NEW Fresh food / jewelry lighting | 334 |
| S Type Series | 336 |

09

Accessories

| | |
|-----------------------|-----|
| Connectors | 340 |
| Aluminum Profile List | 344 |
| LED Driver | 360 |
| Controllers | 368 |
| IP Rating | 372 |
| Naming Guidance | 374 |

① Manufacturing Capacity

Complete production process of LED packaging, high speed SMD, automatic welding and full range of waterproof. Monthly average production capacity of led strip 2,500,000 meters. Stable quality, strong production capacity, strong delivery ability, provide quality products to customers in time.



② R&D Capacity

The company implements agile development on the IPD-based R&D system, responding to customer needs professionally and quickly. We have 40 practical new patents, 3 invention patents, and a team of over 30 technicians, with more than 10 years of experience in the optic industry and technical accumulation in the fields of optics, structuring, technology, material science, electricity, thermology, intelligence control, and industrial design. The company highly values R&D innovation, and we are a multidisciplinary team with a solid theoretical foundation and market foresight.



③ LED Quality Warranty

AURALIGHT has a million-class professional and precision LED dust-free workshop, with oriented production according to ANSI standards. Strict selection of materials, always insist use 99.99% pure gold wire to ensure good conductivity and high temperature resistance. The product with pure color, the center of the color coordinate of each white color temperature is near the black body line, and the XY controlled between 0.005 to 0.007, which is much higher than the industry standard. The product with high color consistency, we can provide single BIN for VIP customers and large projects.

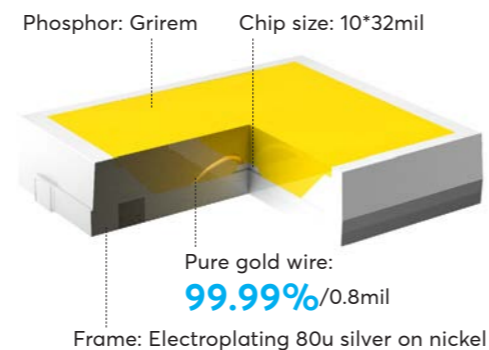

LED Encapsulation Ability



Packaging Process

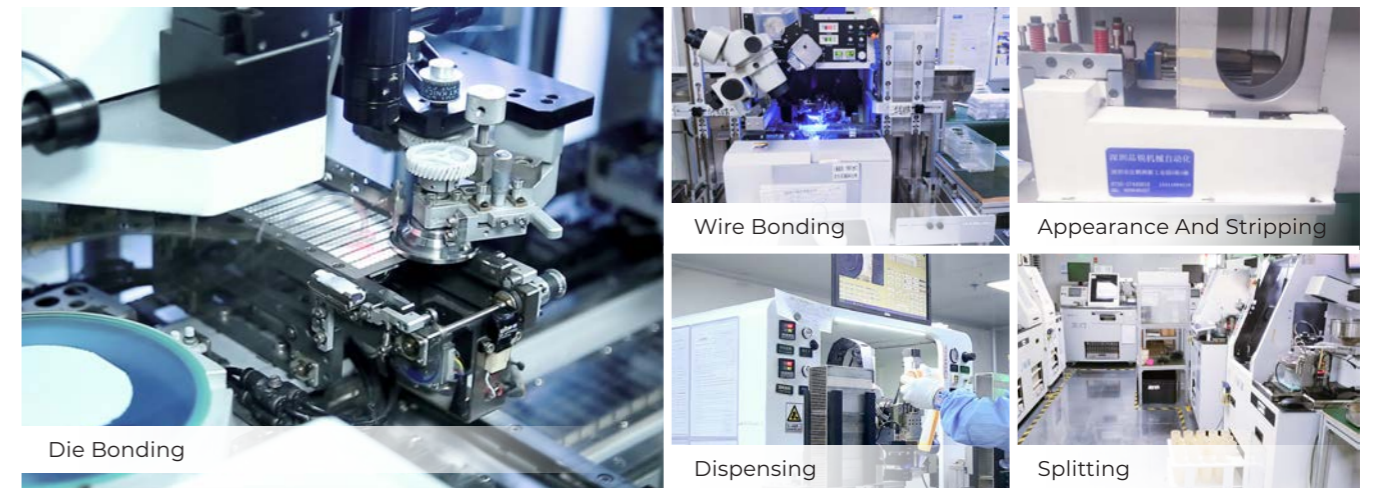

Packaging Equipment



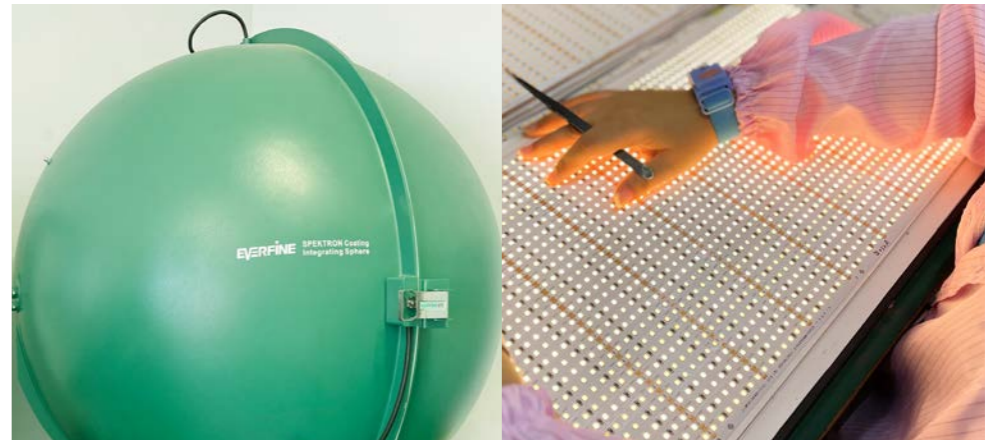
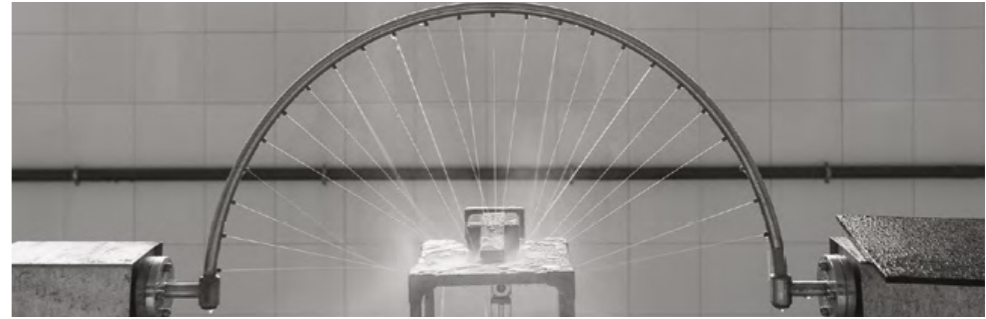
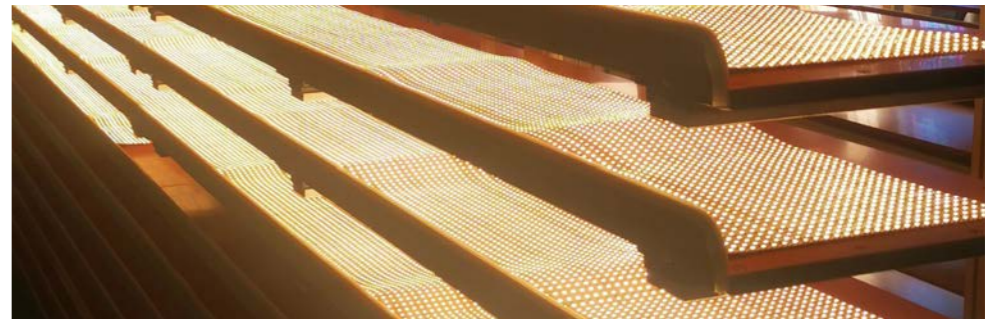
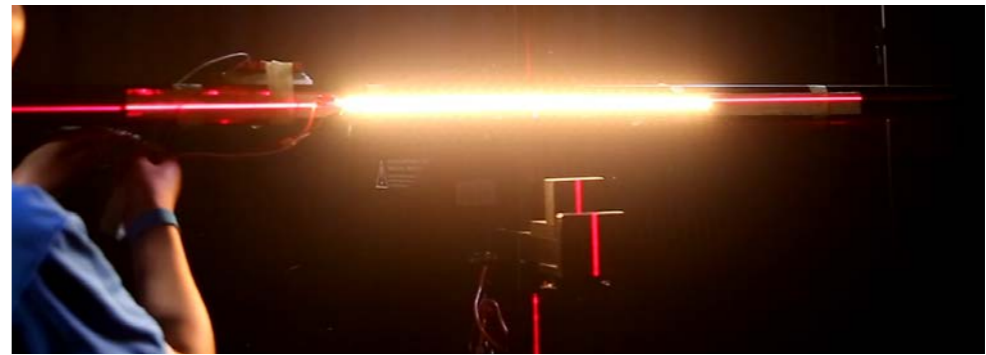

Quality Control Ability

Company has a number of thermal shock, constant temperature and humidity, salt spray test machine, IES tester, integrating sphere, transportation simulation tester etc. To verify and ensure the product meet the standards of photoelectric, lifespan and weather resistance.

Color Consistency

Color temperature control

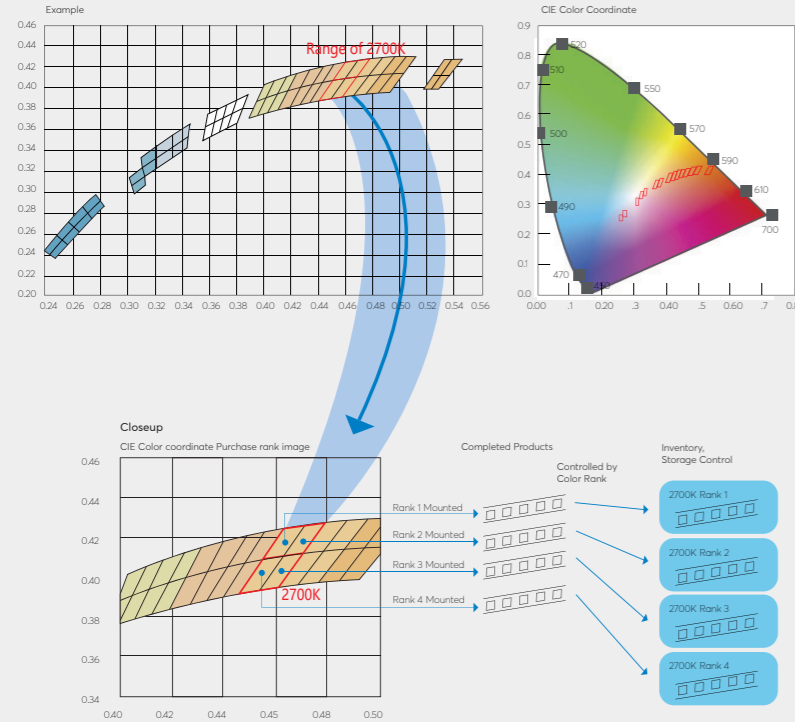

SDCM < 2step ± 50k

Only single Bin in the LED packages would be selected to customer's every and each order. For all the LEDs, there would be additional visual inspection after the selection of machine. All the orders would have both documents record and actual LED samples for comparison. Customized colors are available since we have our own LED packaging facilities.

Please note that the color temperatures of some of the products sold by LEDMY are outside the industry standard to meet the needs of our customers. LEDMY original rules have been set for these.

Full Spectrum

FIDELITY Index (Rf) base on the TM-30

TM-30 is a new and improved IES method for characterizing the color rendering ability of white light sources. While CRI and extended CRI utilize 8 and 15 color samples respectively, they do not necessarily represent the actual colors that we would encounter in the real world. The new fidelity index (Rf) developed under TM-30, dissimilarly utilizes 99 color samples in its calculation, providing a much more statistically representative and reliable metric in describing a light source's ability to faithfully render colors. In line with CRI, the best possible score for Rf under the TM-30 standard is 100.

FULL COLOR GAMUT (Rg) AS PER TM-30-15

In addition to an improved color fidelity metric, the TM-30 method introduces an additional dimension to color quality through the gamut index (Rg). The Rg gamut index provides information about the relative range of colors that can be produced (via reflection) by a white light source. A score close to 100 indicates that, on average, the light source reproduces colors with similar levels of saturation as an incandescent bulb (2700K) or daylight (5600K/6500K). For LEDs of decent color quality, Rg can typically range between 80 and 120, with higher scores representing higher overall levels of saturation.



CRI > 95

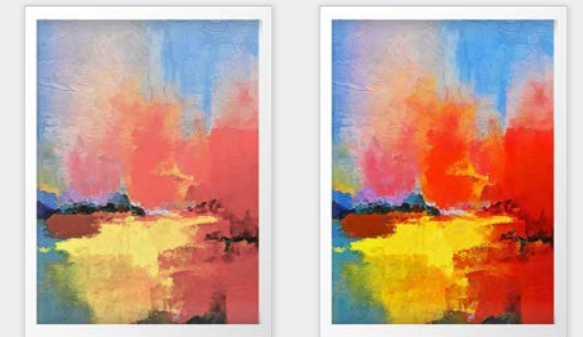

Light color consistency is an important indicator of LED strip quality, while the quality of LED source is determined by LED components. Every process with strict control is vital importance for LED components manufacturing, such as ratio control of phosphors, glue dispensing, sorting, SMT and testing. In order to make sure non-defective passing to our customers, inspections and comparisons of color consistency are needed, the main steps as below:

Step 1

First, inspect the appearance of the LED chip, make sure LED surface is clean, no stains and spots, no short bridging in soldering.

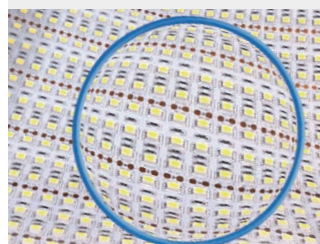

Step 2

Second, laying the finished product on the testing shelf, turn on lights to mark the defective such as dead LEDs, open soldering, glue crack and excessive brightness.



Step 3

Third, cover led source with PMMA board, observe the color of the finished products and compare color with the first piece sample to ensure the color consistency. Meanwhile, mark the defective products with labels.

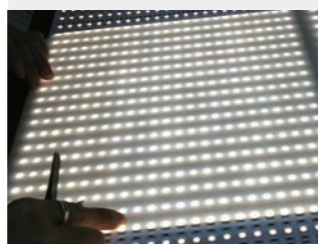

Step 4

Fourth, defective products will be returned for analysis and repairing.

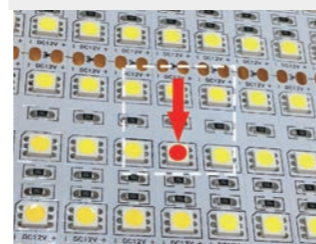

Violet Chip Full Spectrum (Nature Light Series) CRI up to 98

Very similar to sunlight spectrum, make the color of lighting object more close to its color under natural light, high color high similarity to sunlight spectrum, making the color of illuminated object closer to its color which under natural light, high color reproduction, Rf > 98, high color saturation, Rg ≥ 100, lower harmful Blue tu maleta, healthy lighting.

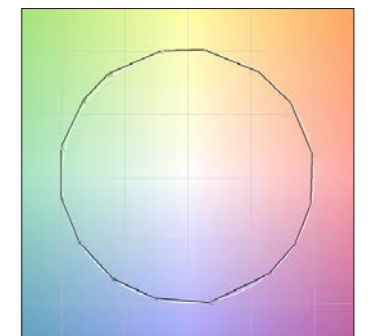
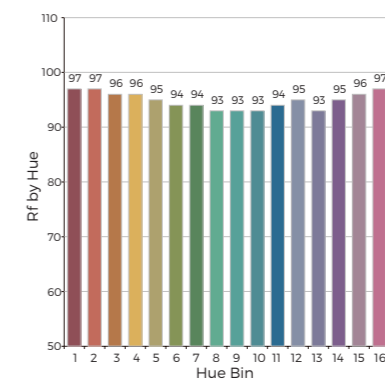
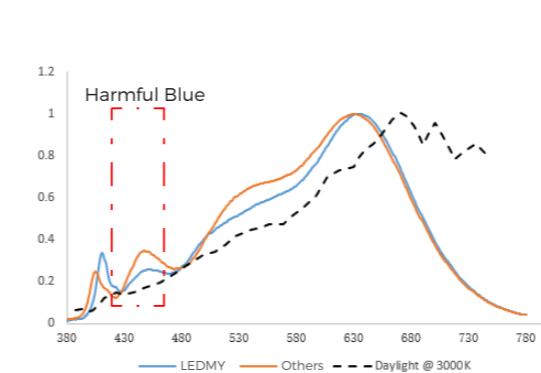

NEW PRODUCT

Classic Series (24V/12V)

Module Wall washer

3D Wall washer

NEON 3D Bending

NEON IP68

NEON Mini

Weldless COB Series

COB Dual-Color Silicone Extrusion

ErP Series

Softer Lightin 1206

Solid Silicone Extrusion 1445

Ultra-Long Series

S Type Series

High Voltage Series

Haute Color Series



12V/24V Classic Series



CRI 95+

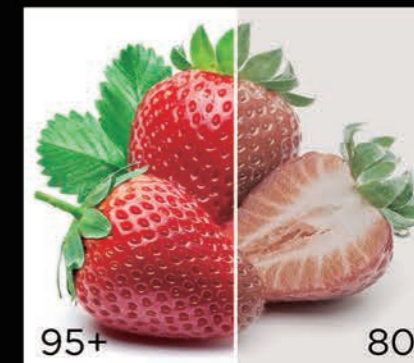

3 STEP

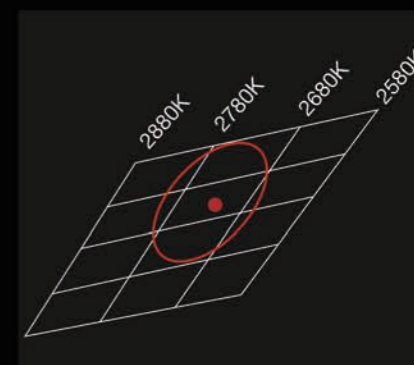

**5 Years
Warranty**



Module Wall washer

Break through space limitations

Designed for unconventional space.
Not just appearance, more creativity and feasibility.



1 Module
Cut



IP67



5
Years
Warranty

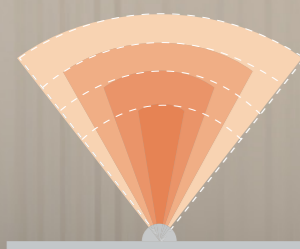

20°
30°
45°
60°
25°x 45°

Various beam angle are available.

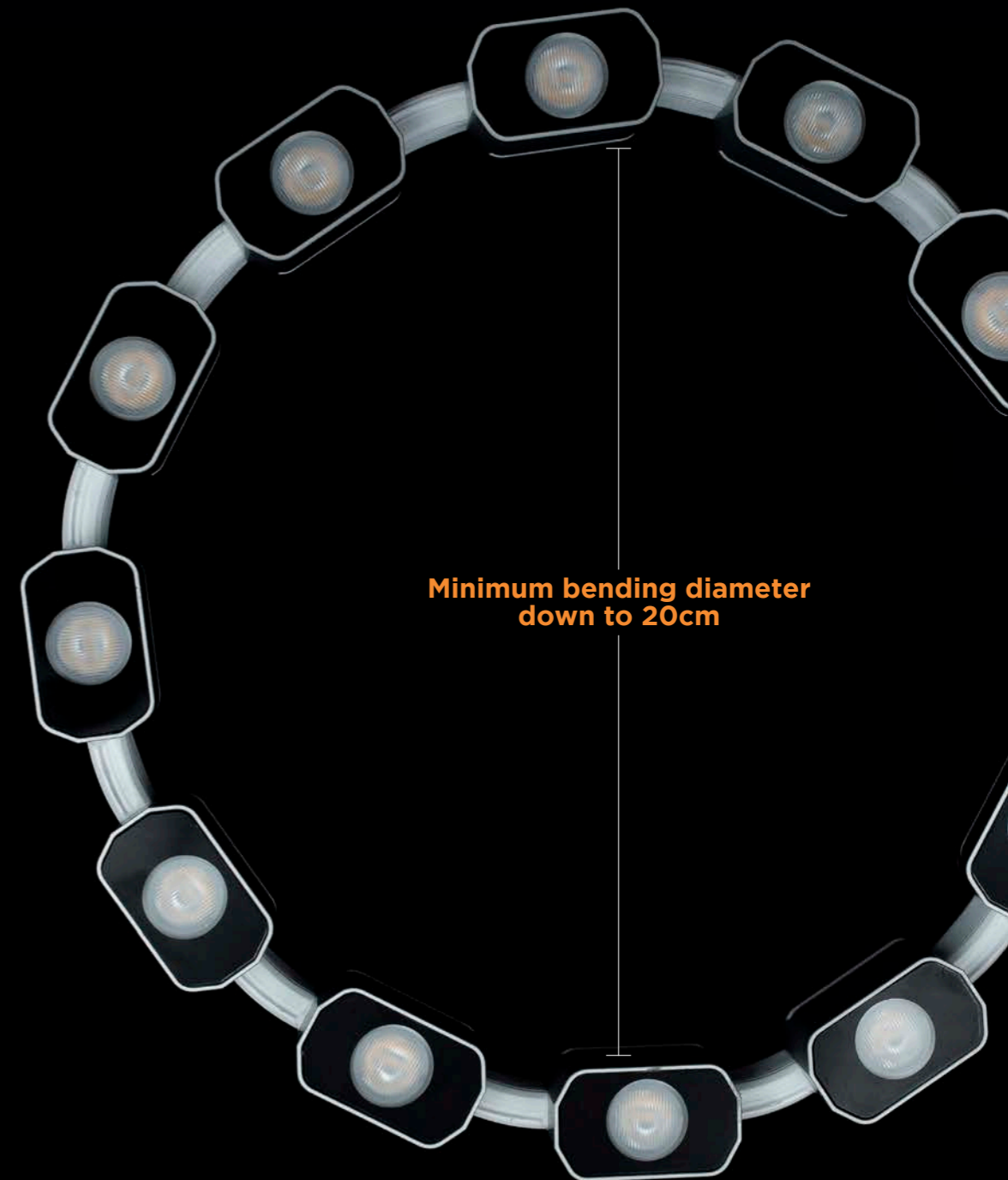

Minimum bending diameter
down to 20cm

Washing height

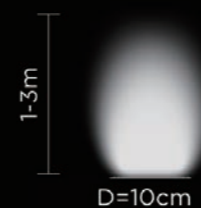

D=10cm



D=20cm



D=30cm



D: Installation distance

3D Wall washer

27x16mm



UV Resistant



IP67



Warranty

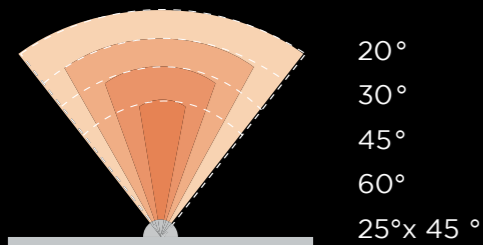

Various beam angle are available.

Bending Freely



Top Bending



Side Bending

Variety of series to meet your needs!

WHITE/RGB/RGBW

3D bending Series

20° 30° 45° 60° 20°x45° / white



Top bending Series

20° 30° 45° 60° 20°x45° / RGB



Top bending Series

20° 30° 45° 60° 20°x45° / RGBW



The details of this product are on page 152.

NEON 3D Bending

Top&side bend integrated

Flexible installation, achieve the creativity break through space limitations.



Flexible installation



Anti-Chlorination



Top Bending



Side Bending

8x8mm 4.8W

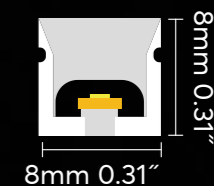

16x18mm 14W

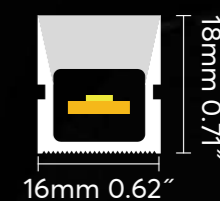

The details of this product are on page 104.

NEON IP68

The product has a water-repellent rating of IP68.
Equipped with a 2835 LED light source that is both bright
and energy-efficient.



IP68



IK08



More safer

Side Bending

10x18mm
14W White

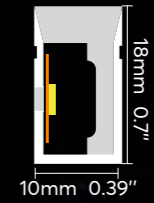

12x20mm
14W DMX RGBW

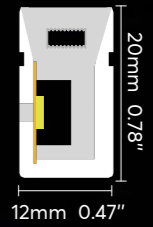

Top Bending

16x16mm
14W White

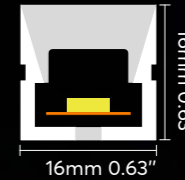

20x18mm
16W DMX RGBW

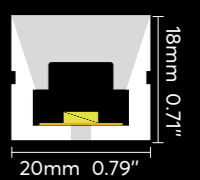

Mini NEON

Free Cutting / Mini Cutting



Mini size



Lights uniform



Outdoor



IP67

Compact size for more applications.
Size down to 3x8mm



The details of this product are on page 66.



More choices!

Side Bending



Top Bending



Weldless COB Series



ErP
qualified



SDCM
5



Better
delivery time



5 years
warranty

- Weldless PCB
- Bigger Chip
- High Efficacy
- More Stable
- Dots-free, uniform lights



The details of this product are on page 128.



Spotless Lighting Series

Beam angle 180°.

High efficacy 2216 Plus LED inside.

Bendable at horizontal direction.

Extrusion process, 3M tape Easy installation.



Cutting free



Beam angle 180°



Higher efficiency



Dots-free

ErP Series UP to 215 LM/W



Up to
215 lm/w

ErP Qualified
Up to Grades B

RA80+
RA90+

Highest Quality
LED chips

3/4OZ PCB

2700-6000K
Multi-color

Low Voltage Drop

The details of this product are on page186.

Softer Lighting

12x6mm



Lights uniform



Outdoor



IP67



Diffuse design,
lights softer.





Ultra-Long

48V Series

Single end power feed carries up to 50M.
Uniform brightness from end to end.
Up to 133LM/W.
Easy to install & save time.

24V Reel to Reel Series

Single end power feed carries up to 20M.
More stable, No quality risk of lap welding.
Long Packing, 100m/reel, 50m/reel, etc.

24V Constant Current Series

Single end power feed carries up to 20M.
Constant current design, bring same brightness from end to end.

The details of this product are on page 234.

S Type Series

Free bending
Easily custom design



Flexible



Multiple colors



Years warranty

Designed for signs

Sculptured lettering and back lit lighting.
Easy to install around tight corners.



The details of this product are on page 336.



High Voltage Series



Ultra-long
up to 50 meters with one end feed.



Stable constant current solution.



The details of this product are on page 324.

Haute Color Series

Use your imagination, and create your own ideas.



ICE BLUE



PINK



TOMATO



VIOLET



ROSE



GOLDEN



For more colors, please go to page 332.

NEON SERIES

Top Bending

Side Bending

Mini NEON

IP68 NEON

Long-Run NEON

Beam NEON

3D Bending NEON

Digital Colorful NEON



Top bending



13x7mm 24V

WHITE / 18W



Arc light-emitting surface, uniform light, not free
 Top emitting, meet a variety of top bending light shape
 IP67, achieve temporary immersion
 With high quality silicon, UV proof for outdoor application



Accessories

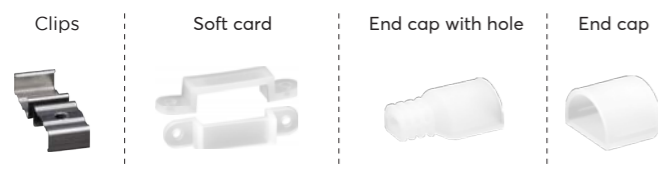

Correct bending way

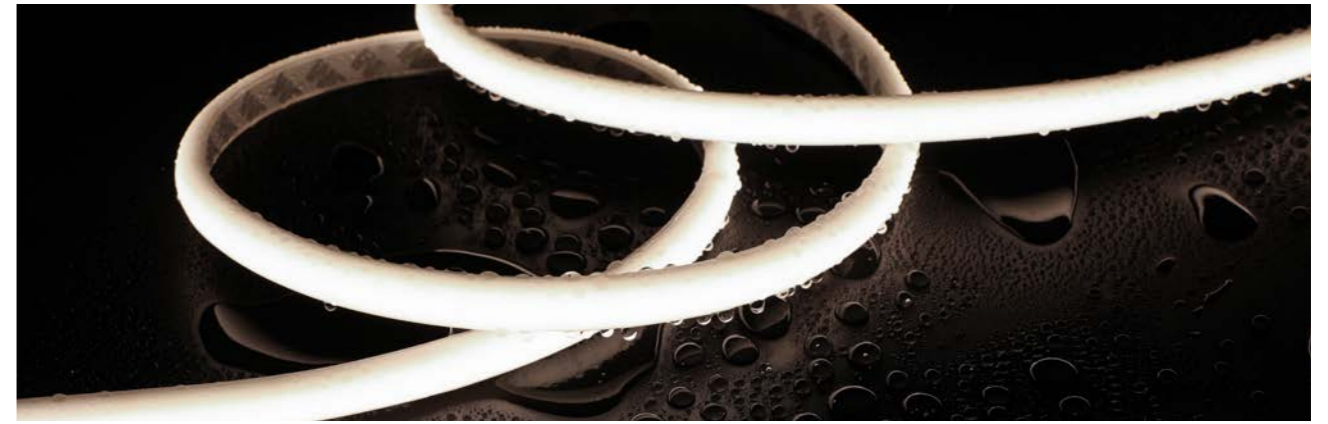

2700K 3000K 4000K 6000K

Technical Details 13x7mm White 18W

| | | | | |
|-------------------|----------------------|----------------------|----------------------|----------------------|
| Product NO. | AU130718WW-24VCLM | | | |
| Voltage | DC24V | | | |
| Power | 18W/M 5.49W/ft | | | |
| CRI | 90 (2835LEDs) | | | |
| Led Qty | 210LEDs/M 64LEDs/ft | | | |
| Cutting Length | 33.3mm 1.31" | | | |
| Waterproof grade | IP67 | | | |
| Length/Reel | 5050mm 16.56ft | | | |
| Color temperature | 2700K | 3000K | 4000K | 6000K |
| Lumens | 1640lm/m 500lm/ft | 1670lm/m 509lm/ft | 1680lm/m 512lm/ft | 1680lm/m 512lm/ft |

Note: 'x' (CCT) = "27"(2700K) / "30"(3000K) / "40"(4000K) / "50"(5000K) / "60"(6000K), Please contact us for more information.

Dimension

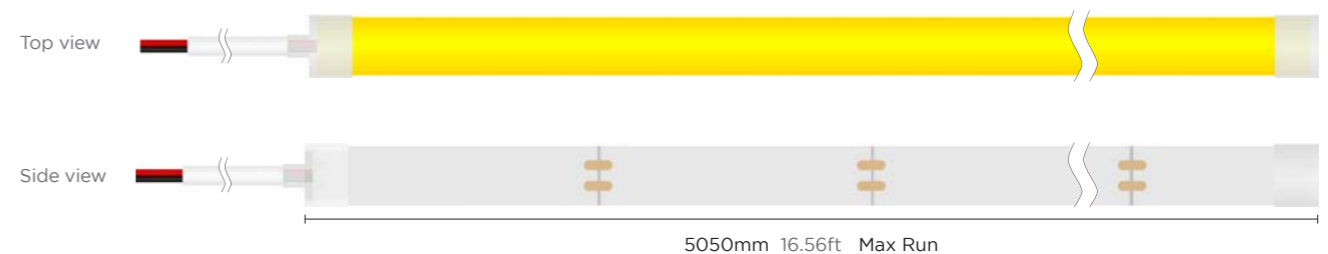

Cross-section

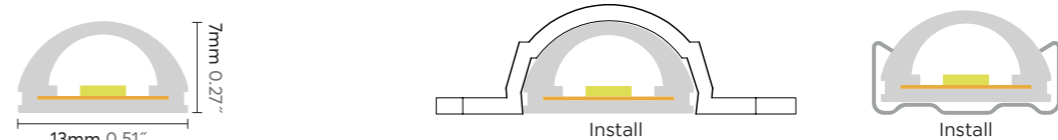

* Please contact our sales for the latest details and certifications

Top bending



16x16mm

WHITE / RGBW



Seamless and uniform light output, dot free.
 Bendable at horizontal direction.
 Robust housing with high quality silicon, UV proof for true outdoor application.

Correct bending way

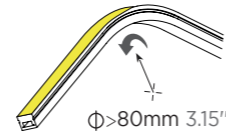

Accessories

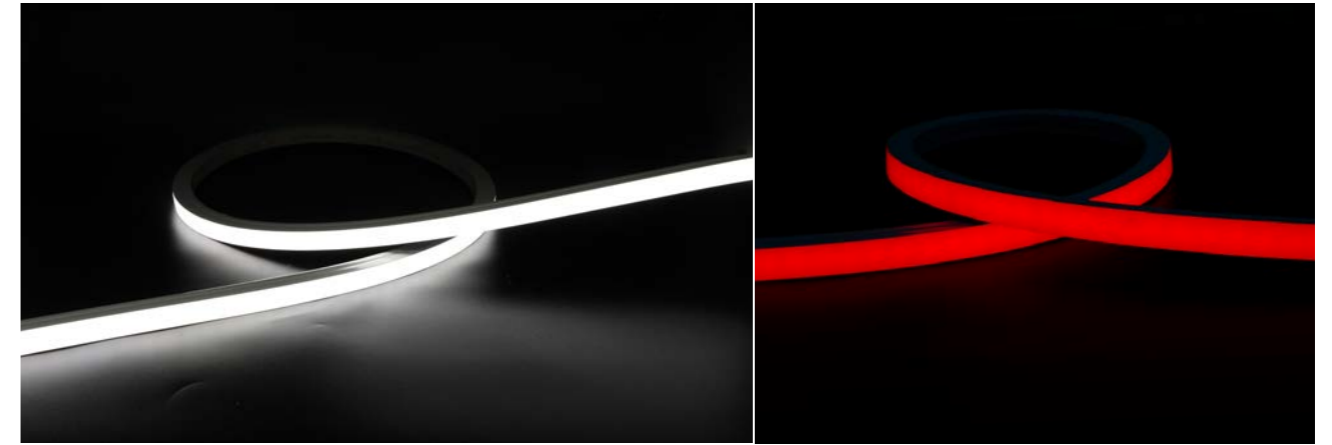

2700K 3000K 4000K 6000K

RGBW

Technical Details 16x16mm White 16W

| | |
|-------------------|---|
| Product NO. | AU161616WW-24VCLM |
| Voltage | DC24V |
| Power | 16W/M 4.87W/ft |
| CRI | 90 (2835LEDs) |
| Led Qty | 140LEDs/M 42LEDs/ft |
| Cutting Length | 50mm 1.97" |
| Waterproof grade | IP67 |
| Length/Reel | 5050mm 16.56ft |
| Color temperature | ● 2700K ● 3000K ● 4000K ○ 6000K |
| Lumens | 920lm/m 280lm/ft 940lm/m 286lm/ft 960lm/m 292lm/ft 960lm/m 292lm/ft |

16x16mm RGBW 15W

| | |
|-------------------|---|
| Product NO. | AU161615WR-24VCLM |
| Voltage | DC24V |
| Power | 15W/M 4.57W/ft |
| CRI | / (5050LEDs) |
| Led Qty | 96LEDs/M 29LEDs/ft |
| Cutting Length | 62.5mm 2.46" |
| Waterproof grade | IP67 |
| Length/Reel | 5050mm 16.56ft |
| Color temperature | ● R ● G ● B ● 3000K |
| Lumens | 58lm/m 17lm/ft 150lm/m 45lm/ft 37lm/m 11lm/ft 144lm/m 43lm/ft |

Note: 'x' (CCT) = "27"(2700K) / "30"(3000K) / "40"(4000K) / "50"(5000K) / "60"(6000K), Please contact us for more information.

Dimension

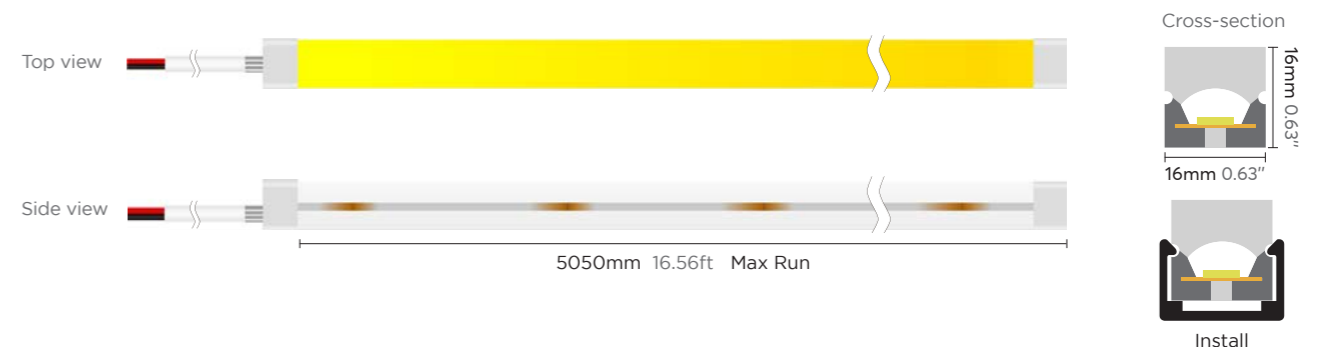

* Please contact our sales for the latest details and certifications

Top bending



20x20mm

WHITE / 14W

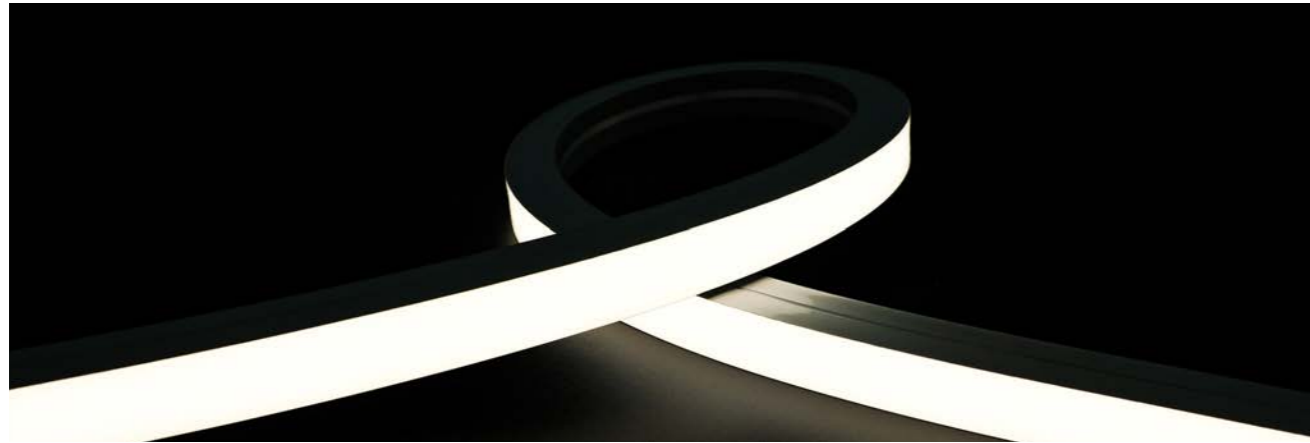

Seamless and uniform light output, dot free.
 Bendable at horizontal direction.
 IP67 protection.
 Robust housing with high quality silicon, UV proof for true outdoor application.

Correct bending way

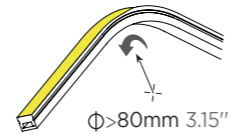

Accessories



2700K 3000K 4000K 6000K

Technical Details 2020 White 14W 5M

| | | | | |
|-------------------|---------------------|---------------------|---------------------|---------------------|
| Product NO. | AU202014WW-24VCLM | | | |
| Voltage | DC24V | | | |
| Power | 14W/M 4.26W/ft | | | |
| CRI | 90 (2835LEDs) | | | |
| Led Qty | 120LEDs/M 36LEDs/ft | | | |
| Cutting Length | 50mm 1.97" | | | |
| Waterproof grade | IP67 | | | |
| Length/Reel | 5050mm 16.56ft | | | |
| Color temperature | ● 2700K | ● 3000K | ● 4000K | ○ 6000K |
| Lumens | 670lm/m 204lm/ft | 670lm/m 204lm/ft | 690lm/m 210lm/ft | 690lm/m 210lm/ft |

Note: 'x' (CCT) = *27*(2700K) / *30*(3000K) / *40*(4000K) / *50*(5000K) / *60*(6000K), Please contact us for more information.

Dimension

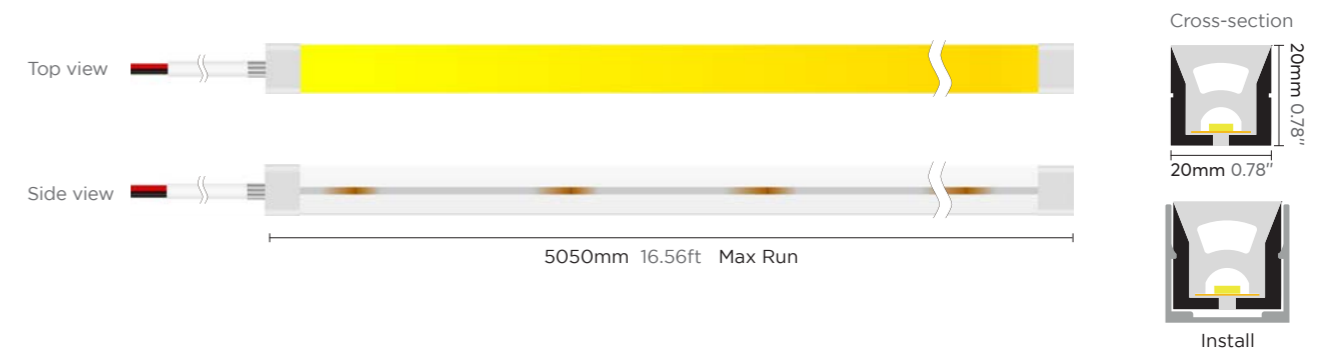

* Please contact our sales for the latest details and certifications

Top bending



25x25mm

White / 16W



Seamless and uniform light output, dot free.
 Bendable at horizontal direction.
 IP67 protection.
 Robust housing with high quality silicon, UV proof for true outdoor application.

Correct bending way

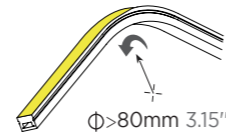

Accessories



2700K 3000K 4000K 6000K

Technical Details 25x25 White 16W

| | | | | |
|-------------------|---------------------|---------------------|---------------------|---------------------|
| Product NO. | AU252516WW-24VCLM | | | |
| Voltage | DC24V | | | |
| Power | 16W/M 4.87W/ft | | | |
| CRI | 90 (2835LEDs) | | | |
| Led Qty | 120LEDs/M 36LEDs/ft | | | |
| Cutting Length | 50mm 1.97" | | | |
| Waterproof grade | IP67 | | | |
| Length/Reel | 5050mm 16.56ft | | | |
| Color temperature | ● 2700K | ● 3000K | ● 4000K | ○ 6000K |
| Lumens | 620lm/m 189lm/ft | 620lm/m 189lm/ft | 630lm/m 192lm/ft | 630lm/m 192lm/ft |

Note: 'x' (CCT) = *27*(2700K) / *30*(3000K) / *40*(4000K) / *50*(5000K) / *60*(6000K), Please contact us for more information.

Dimension



* Please contact our sales for the latest details and certifications

Side bending



6x12mm

WHITE / RGB



6mm light-emitting surface, uniform light, dot free.
 Side emitting, meet a variety of side bending light shape.
 Robust housing with high quality silicon, UV proof for true outdoor application.
 Easy installation with clips and bendable track.
 Cutable for flexible application.

Correct bending way

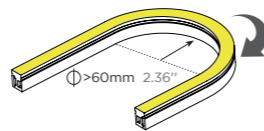

Accessories

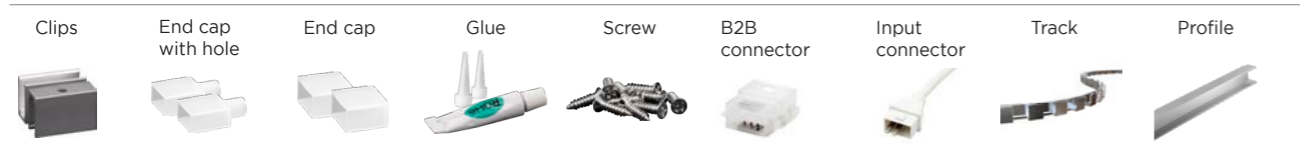

2700K 3000K 4000K 6000K



| Technical Details | 6x12mm White 10W | 6x12mm RGB 10W |
|-------------------|---|--|
| Product NO. | AU061210WW-24VCLM | AU061210WR-24VCLM |
| Voltage | DC24V | DC24V |
| Power | 10W/M 3.04W/ft | 10W/M 3.04W/ft |
| CRI | 90 (2835LEDs) | - (3838LEDs) |
| Led Qty | 140LEDs/M 42LEDs/ft | 120LEDs/M 36LEDs/ft |
| Cutting Length | 50mm 1.97" | 50mm 1.97" |
| Waterproof grade | IP67 | IP67 |
| Length/Reel | 5050mm 16.56ft | 5050mm 16.56ft |
| Color temperature | ● 2700K ● 3000K ● 4000K ○ 6000K | ● R ● G ● B |
| Lumens | 280lm/m 85lm/ft 280lm/m 85lm/ft 285lm/m 87lm/ft 285lm/m 87lm/ft | 36lm/m 11lm/ft 100lm/m 30lm/ft 22lm/m 7lm/ft |

Note: 'x' (CCT) = "27"(2700K) / "30"(3000K) / "40"(4000K) / "50"(5000K) / "60"(6000K), Please contact us for more information.

Dimension

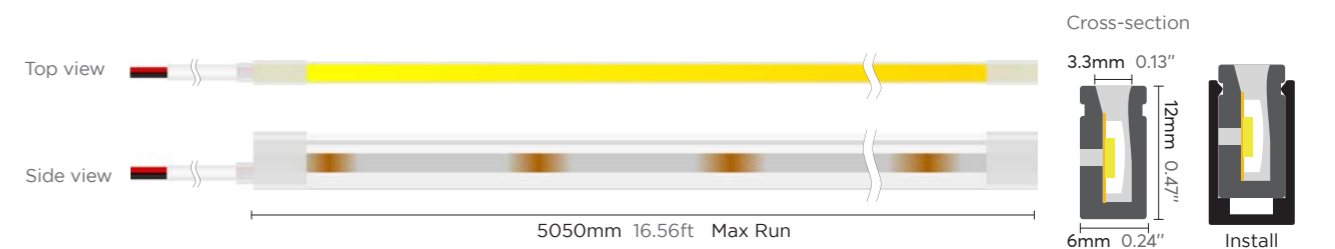

* Please contact our sales for the latest details and certifications

Side bending



8x16mm

WHITE / RGB



Three-sided luminous, wide angle, uniform light, dot free.
 Bendable at horizontal direction.
 Robust housing with high quality silicon, UV proof for true outdoor application.
 Easy installation with clips and bendable track.
 Cut-able for flexible application.



Correct bending way

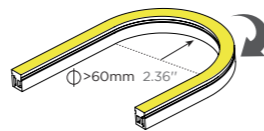

Accessories

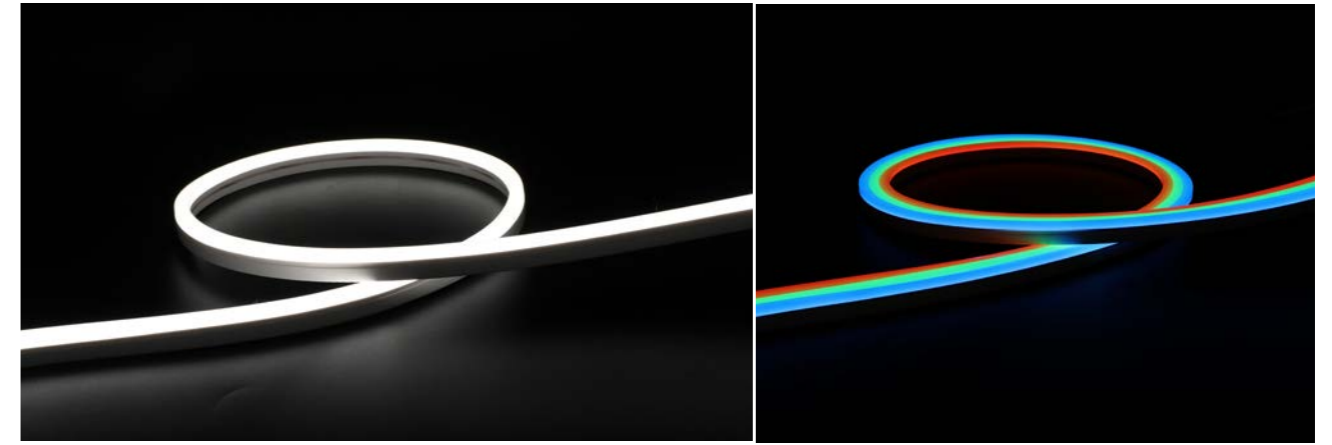

2700K 3000K 4000K 6000K



Technical Details 8x16mm White 12W

| | |
|-------------------|--|
| Product NO. | AU081612WW-24VCLM |
| Voltage | DC24V |
| Power | 12W/M 3.65W/ft |
| CRI | 90 (2835LEDs) |
| Led Qty | 140LEDs/M 42LEDs/ft |
| Cutting Length | 50mm 1.97" |
| Waterproof grade | IP67 |
| Length/Reel | 5050mm 16.56ft |
| Color temperature | <input checked="" type="radio"/> 2700K <input type="radio"/> 3000K <input type="radio"/> 4000K <input type="radio"/> 6000K |
| Lumens | 495lm/m 151lm/ft 500lm/m 152lm/ft 535lm/m 163lm/ft 535lm/m 163lm/ft |

8x16mm RGB 12W

| | |
|-------------------|--|
| Product NO. | AU081612WR-24VCLM |
| Voltage | DC24V |
| Power | 12W/M 3.65W/ft |
| CRI | - (3838LEDs) |
| Led Qty | 120LEDs/M 36LEDs/ft |
| Cutting Length | 50mm 1.97" |
| Waterproof grade | IP67 |
| Length/Reel | 5050mm 16.56ft |
| Color temperature | <input checked="" type="radio"/> R <input checked="" type="radio"/> G <input checked="" type="radio"/> B |
| Lumens | 43lm/m 13lm/ft 122lm/m 37lm/ft 26lm/m 8lm/ft |

Note: 'x' (CCT) = *27*(2700K) / *30*(3000K) / *40*(4000K) / *50*(5000K) / *60*(6000K), Please contact us for more information.

Dimension



* Please contact our sales for the latest details and certifications

Side bending



10x18mm

White / Tunable White

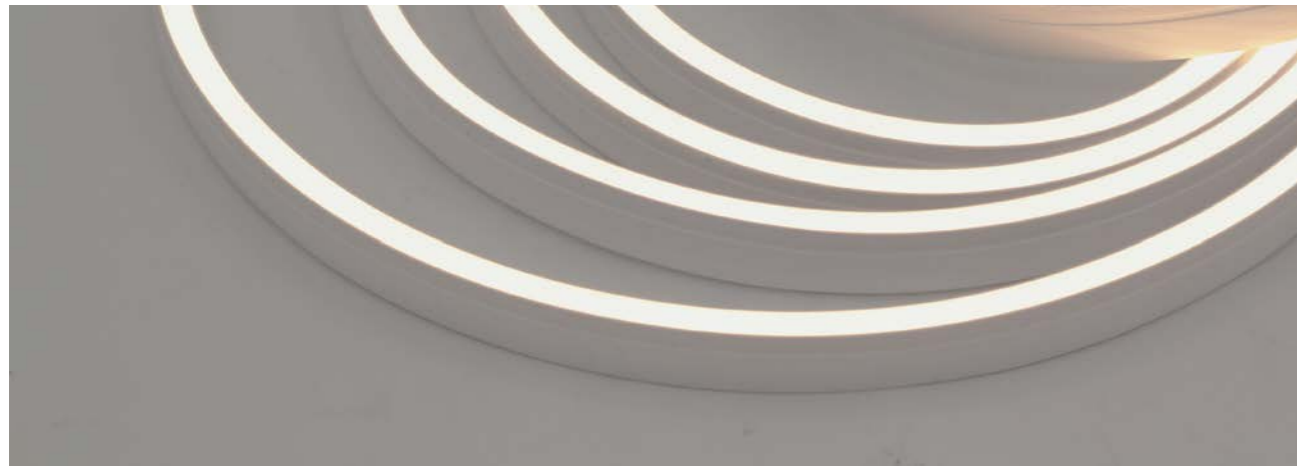

10mm light-emitting surface, uniform light, dot free.
 White Side emitting, meet a variety of side bending light shape.
 IP67, achieve temporary immersion.
 With high quality silicon, UV proof for outdoor application.

Correct bending way

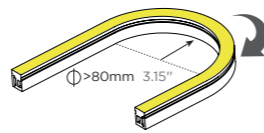

Accessories



2700K 3000K 4000K 6000K

2700K 6000K

Technical Details 10x18mm White 14W

| | |
|-------------------|--|
| Product NO. | AU101814WW-24VCLM |
| Voltage | DC24V |
| Power | 14.4W/M 4.39W/ft |
| CRI | 90 (2835LEDs) |
| Led Qty | 140LEDs/M 42LEDs/ft |
| Cutting Length | 50mm 1.97" |
| Waterproof grade | IP67 |
| Length/Reel | 5050mm 16.56ft |
| Color temperature | ● 2700K ● 3000K ● 4000K ○ 6000K |
| Lumens | 560lm/m 565lm/m 565lm/m 565lm/m 170lm/ft 172lm/ft 172lm/ft 172lm/ft |

10x18mm 19W Tunable White

| | |
|-------------------|--------------------------------------|
| Product NO. | AU101819WW-24VCLM |
| Voltage | DC24V |
| Power | 19.2W/M 5.85W/ft |
| CRI | 90 (2835LEDs) |
| Led Qty | 240LEDs/M 73LEDs/ft |
| Cutting Length | 50mm 1.97" |
| Waterproof grade | IP67 |
| Length/Reel | 5050mm 16.56ft |
| Color temperature | ● 2700K ○ 6000K |
| Lumens | 350lm/m 380lm/m 106lm/ft 115lm/ft |

Note: 'x' (CCT) = *27*(2700K) / *30*(3000K) / *40*(4000K) / *50*(5000K) / *60*(6000K). Please contact us for more information.

Dimension

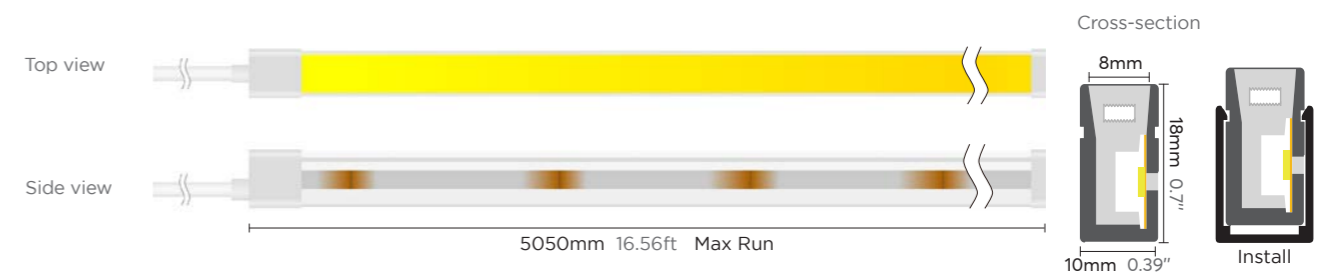

※ Please contact our sales for the latest details and certifications

Side bending



10x18mm

RGB / RGBW



Seamless and uniform light output, dot free Bendable at horizontal direction.
Robust housing with high quality silicon, UV proof for true outdoor application.
Cut-able for flexible application, easy installation with clips and bendable track.
4 in 1, can achieve a variety of colors.



Correct bending way

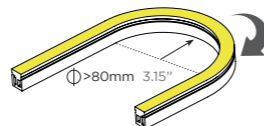

Accessories

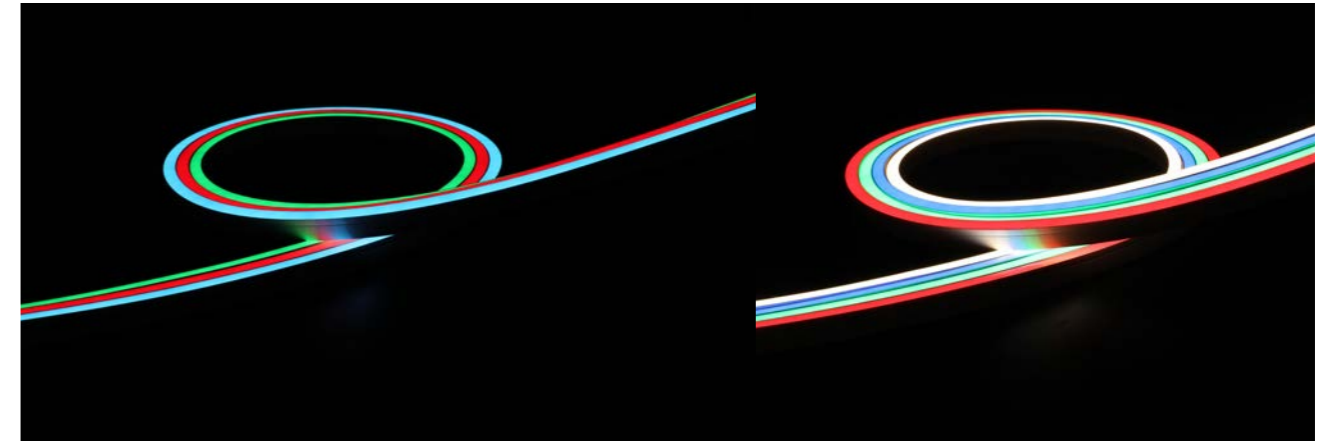

Technical Details 10x18mm RGB 14W

10x18mm 14W RGBW

| | | |
|------------------|--------------------|-------------------------|
| Product NO. | AU101814WR-24VCLM | AU101814WRW-24VCLM |
| Voltage | DC24V | DC24V |
| Power | 14.4W/M 4.39W/ft | 14.4W/M 4.39W/ft |
| CRI | - (5050LEDs) | 80 (5050LEDs) |
| Led Qty | 60LEDs/M 18LEDs/ft | 60LEDs/M 18LEDs/ft |
| Cutting Length | 50mm 1.97" | 50mm 1.97" |
| Waterproof grade | IP67 | IP67 |
| Length/Reel | 5050mm 16.56ft | 5050mm 16.56ft |
| Lumens | | 60lm/m 18lm/ft |
| ● R | 50lm/m 15lm/ft | ● 3000K 165lm/m 50lm/ft |
| ● G | 120lm/m 36lm/ft | ● 4000K 180lm/m 54lm/ft |
| ● B | 30lm/m 9lm/ft | ○ 6000K 160lm/m 48lm/ft |

Note: 'x' (CCT) = "27"(2700K) / "30"(3000K) / "40"(4000K) / "50"(5000K) / "60"(6000K), Please contact us for more information.

Dimension

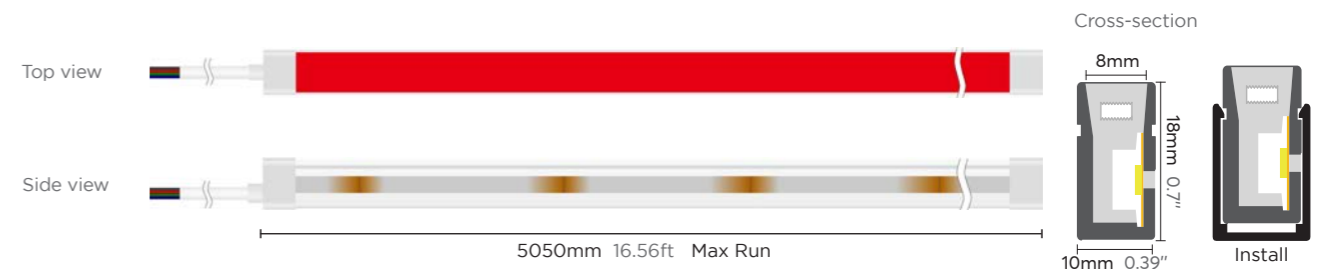

* Please contact our sales for the latest details and certifications

Side bending



12x20mm

WHITE 15W / Tunable white 12W



12mm light-emitting surface, uniform light, dot free.
 White Side emitting, meet a variety of side bending light shape.
 IP67, achieve temporary immersion.
 With high quality silicon, UV proof for outdoor application.

Correct bending way

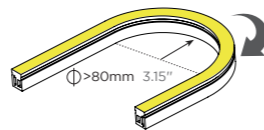

Accessories



2700K 3000K 4000K 6000K

2700K 6000K

Technical Details 12x20mm White 15W

| | |
|-------------------|---|
| Product NO. | AU122015WW-24VCLM |
| Voltage | DC24V |
| Power | 15W/M 4.57W/ft |
| CRI | 90 (2835LEDs) |
| Led Qty | 120LEDs/M 36LEDs/ft |
| Cutting Length | 50mm 1.97" |
| Waterproof grade | IP67 |
| Length/Reel | 5050mm 16.56ft |
| Color temperature | ● 2700K ● 3000K ● 4000K ○ 6000K |
| Lumens | 390lm/m 118lm/ft 390lm/m 118lm/ft 400lm/m 121lm/ft 400lm/m 121lm/ft |

12x20mm Tunable white 12W

| | |
|-------------------|---------------------------------|
| Product NO. | AU122012WW-24VCLM |
| Voltage | DC24V |
| Power | 12W/M 3.65W/ft |
| CRI | 90 (2835LEDs) |
| Led Qty | 112LEDs/M 34LEDs/ft |
| Cutting Length | 125mm 4.92" |
| Waterproof grade | IP67 |
| Length/Reel | 5050mm 16.56ft |
| Color temperature | ● 2700K ○ 6000K |
| Lumens | 160lm/m 49lm/ft 180lm/m 55lm/ft |

Note: 'x' (CCT) = *27*(2700K) / *30*(3000K) / *40*(4000K) / *50*(5000K) / *60*(6000K). Please contact us for more information.

Dimension

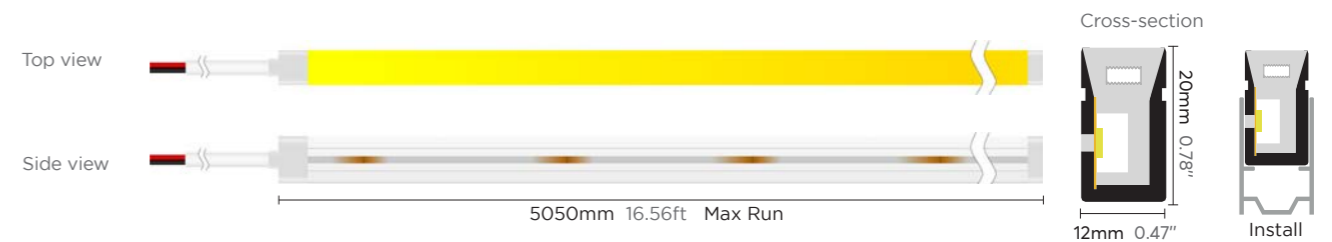

* Please contact our sales for the latest details and certifications

Side bending



12x25mm

WHITE / 14W



12mm Cambered surface lighting, dot free.
 White side emitting, meet a variety of side bending light shape.
 IP67, achieve temporary immersion.
 With high quality silicon, UV proof for outdoor application.

Correct bending way

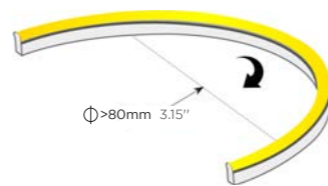

Accessories

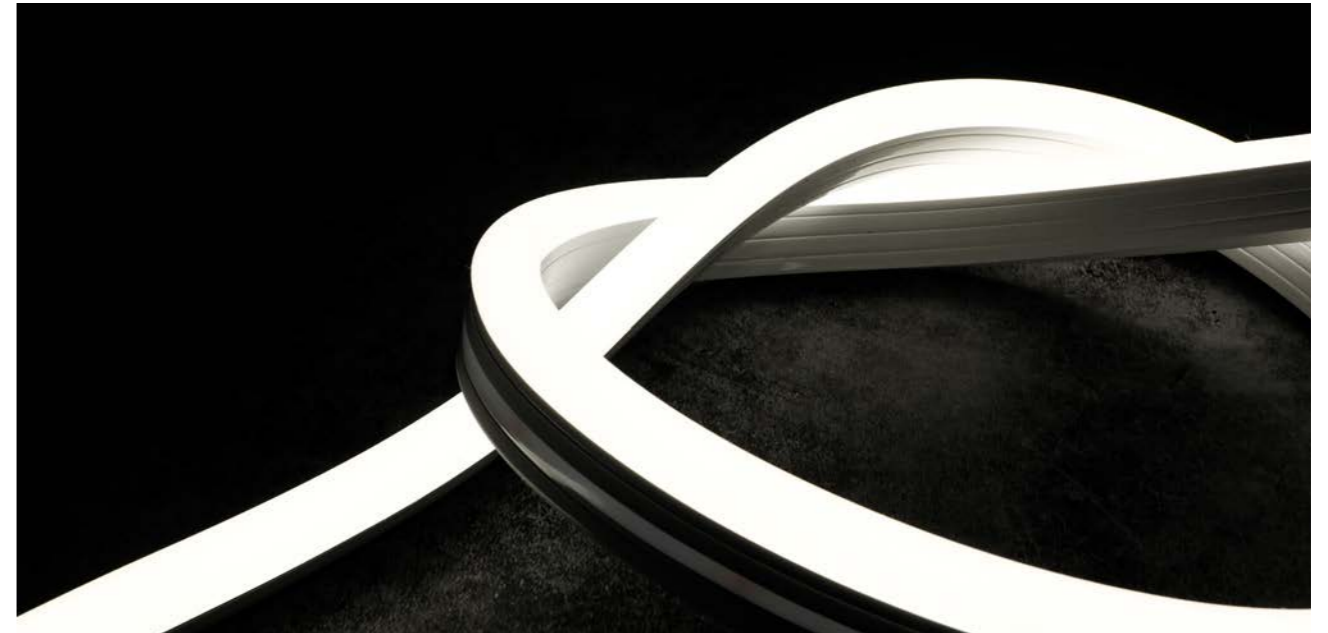

2700K 3000K 4000K 6000K

Technical Details 12x25mm White 14W

| | | | | |
|-------------------|---------------------|---------------------|---------------------|---------------------|
| Product NO. | AU122514WW-24VCLM | | | |
| Voltage | DC24V | | | |
| Power | 14W/M 4.26W/ft | | | |
| CRI | 90 (2835LEDs) | | | |
| Led Qty | 120LEDs/M 36LEDs/ft | | | |
| Cutting Length | 50mm 1.97" | | | |
| Waterproof grade | IP67 | | | |
| Length/Reel | 5050mm 16.56ft | | | |
| Color temperature | ● 2700K | ● 3000K | ● 4000K | ○ 6000K |
| Lumens | 450lm/m 137lm/ft | 450lm/m 137lm/ft | 460lm/m 140lm/ft | 460lm/m 140lm/ft |

Note: 'x' (CCT) = *27*(2700K) / *30*(3000K) / *40*(4000K) / *50*(5000K) / *60*(6000K), Please contact us for more information.

Dimension

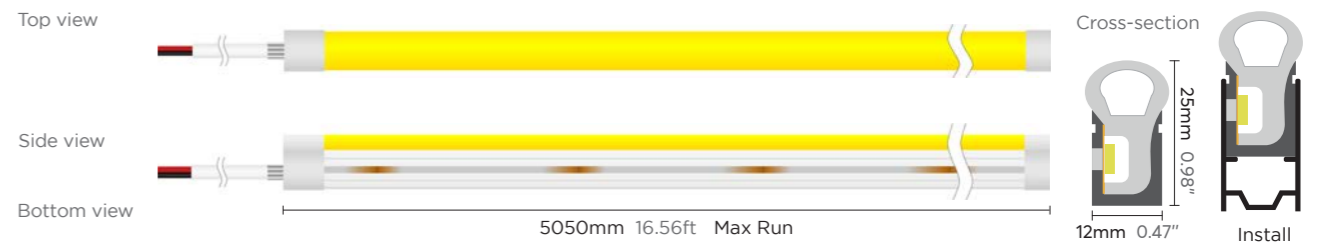

※ Please contact our sales for the latest details and certifications

Mini NEON

Side bending



3x8mm

WHITE / 10W

Extrusion process, lights soft and uniform.
3mm wide with ultra narrow output.
Bendable at horizontal direction.
Robust housing with high quality silicon.
Cut-able for flexible application.



Accessories



Correct bending way

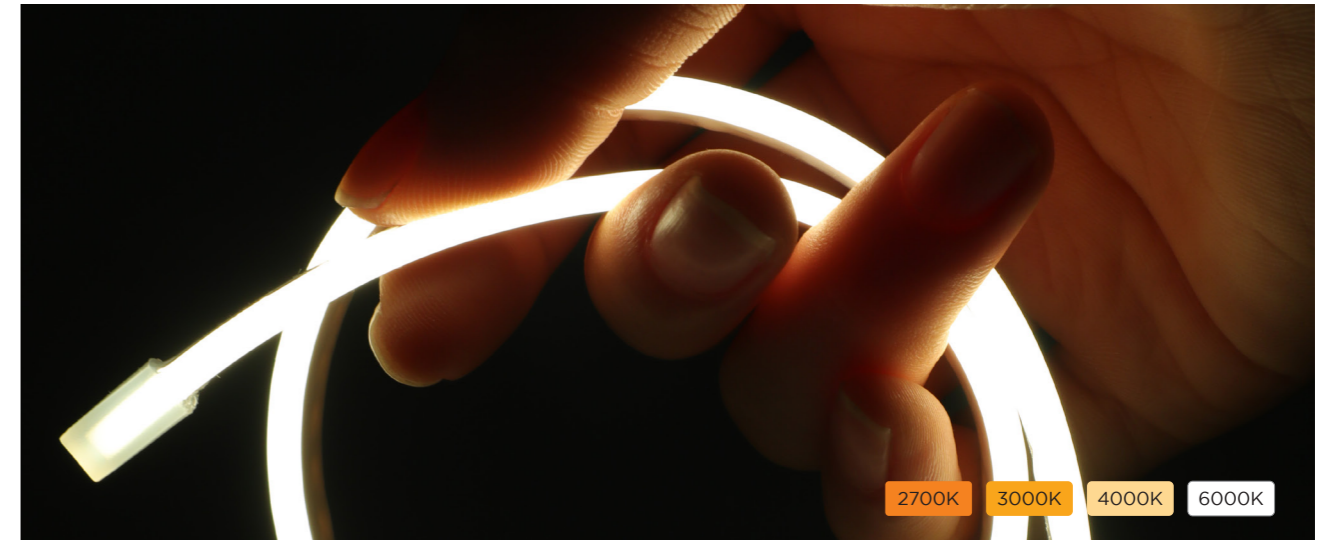
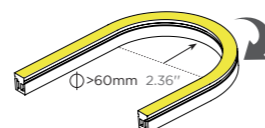

Technical Details **3x8mm White 6W**

| | | | | |
|-------------------|--|--|-----------------------------|-----------------------------|
| Product NO. | AU030806WW-24VCLM-MINI | | | |
| Voltage | DC24V | | | |
| Power | 6W/M 1.82W/ft | | | |
| CRI | 90 (2216LEDs) | | | |
| Led Qty | 238LEDs/M 73LEDs/ft | | | |
| Cutting Length | Free cutting | | | |
| Waterproof grade | IP67 | | | |
| Length/Reel | 5050mm 16.56ft | | | |
| Color temperature | <input checked="" type="radio"/> 2700K | <input checked="" type="radio"/> 3000K | <input type="radio"/> 4000K | <input type="radio"/> 6000K |
| Lumens | 170lm/m 52lm/ft | 180lm/m 55lm/ft | 185lm/m 56lm/ft | 185lm/m 56lm/ft |

Note: 'x' (CCT) = "27"(2700K) / "30"(3000K) / "40"(4000K) / "50"(5000K) / "60"(6000K), Please contact us for more information.

Dimension



* Please contact our sales for the latest details and certifications

Mini NEON

Side bending

4x8mm

WHITE / 10W

Extrusion process, lights soft and uniform.
 3.5mm wide with ultra narrow output.
 Bendable at horizontal direction.
 Robust housing with high quality silicon, UV proof for true outdoor application.
 Cutable for flexible application.



NEON SERIES · MINI NEON

Accessories



Correct bending way

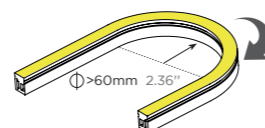

Technical Details 4x8mm White 6W

| | | | | |
|-------------------|--|--|--|-----------------------------|
| Product NO. | AU040806WW-24VCLM-MINI | | | |
| Voltage | DC24V | | | |
| Power | 6W/M 1.82W/ft | | | |
| CRI | 90 (2835LEDs) | | | |
| Led Qty | 180LEDs/M 54LEDs/ft | | | |
| Cutting Length | 33.3mm 1.3" | | | |
| Waterproof grade | IP67 | | | |
| Length/Reel | 5050mm 16.56ft | | | |
| Color temperature | <input checked="" type="radio"/> 2700K | <input checked="" type="radio"/> 3000K | <input checked="" type="radio"/> 4000K | <input type="radio"/> 6000K |
| Lumens | 120lm/m 36lm/ft | 123lm/m 37lm/ft | 126lm/m 38lm/ft | 126lm/m 38lm/ft |

Note: 'x' (CCT) = "27"(2700K) / "30"(3000K) / "40"(4000K) / "50"(5000K) / "60"(6000K), Please contact us for more information.

Dimension

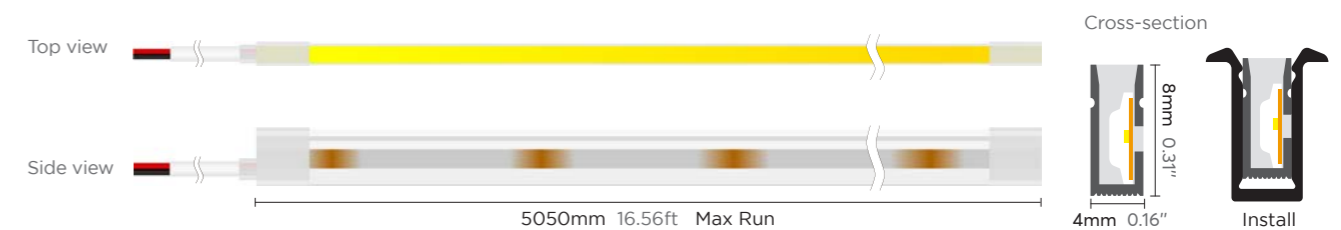

* Please contact our sales for the latest details and certifications

NEON SERIES · MINI NEON

Mini NEON

Side bending

4x10(T)mm

WHITE / 10W



Profile free, perfect fit-in, no gap left.
6mm T-Shape lighting, larger luminous surface, lights soft and uniform.
Bendable at horizontal direction.
Robust housing with high quality silicon, UV proof for true outdoor application.
Cut-able for flexible application.



Correct bending way

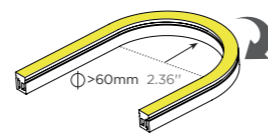

Accessories



2700K 3000K 4000K 6000K



T-Shape lighting

Technical Details 4x10(T)mm White 10W

| | | | | |
|-------------------|-------------------------|--------------------|--------------------|--------------------|
| Product NO. | AU0410T10WW-24VCLM-MINI | | | |
| Voltage | DC24V | | | |
| Power | 10W/M 3.04W/ft | | | |
| CRI | 90 (2835LEDs) | | | |
| Led Qty | 180LEDs/M | | | |
| Cutting Length | 33.33mm 1.31" | | | |
| Waterproof grade | IP67 | | | |
| Length/Reel | 5050mm 16.56ft | | | |
| Color temperature | ● 2700K | ● 3000K | ● 4000K | ○ 6000K |
| Lumens | 270lm/m 82lm/ft | 290lm/m 88lm/ft | 310lm/m 95lm/ft | 310lm/m 95lm/ft |

Note: 'x' (CCT) = "27"(2700K) / "30"(3000K) / "40"(4000K) / "50"(5000K) / "60"(6000K), Please contact us for more information.

Dimension



* Please contact our sales for the latest details and certifications

Mini NEON

 Side bending

4x10mm

WHITE / 10W



Extrusion process, lights soft and uniform.
3.5mm wide with ultra narrow output.
Bendable at horizontal direction.
Robust housing with high quality silicon, UV proof for true outdoor application.
Cut-able for flexible application.



Correct bending way

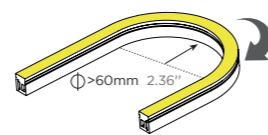

Accessories

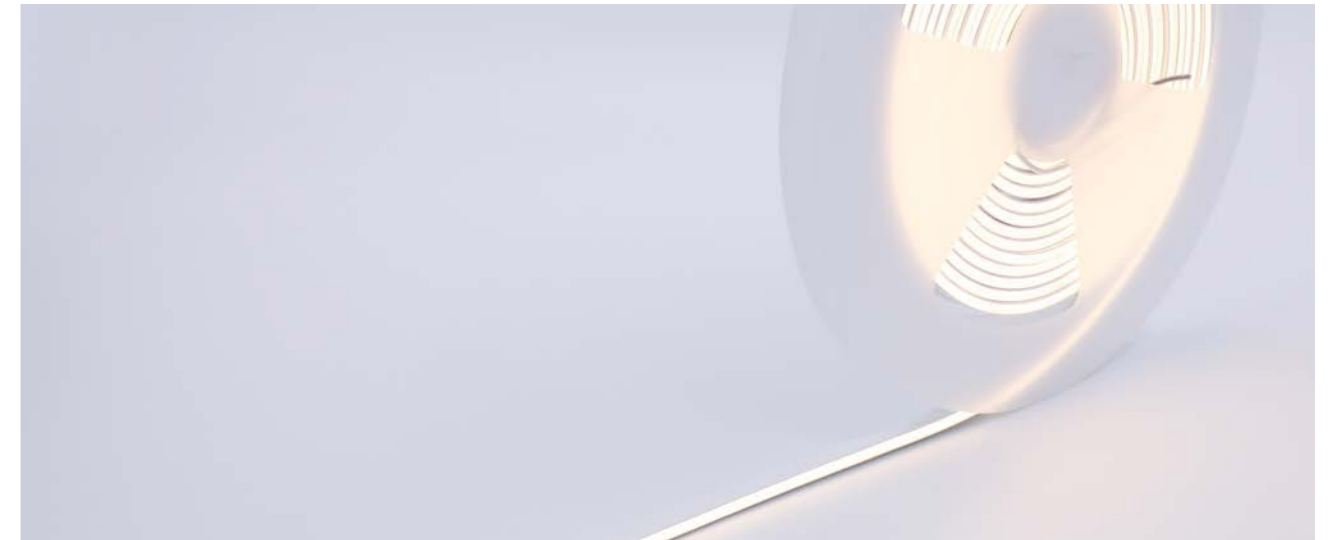

2700K 3000K 4000K 6000K

Technical Details 4x10mm White 10W

| | | | | |
|-------------------|------------------------|--------------------|--------------------|--------------------|
| Product NO. | AU041010WW-24VCLM-MINI | | | |
| Voltage | DC24V | | | |
| Power | 10W/M 3.04W/ft | | | |
| CRI | 90 (2835LEDs) | | | |
| Led Qty | 144LEDs/M | | | |
| Cutting Length | 41.6mm 1.63" | | | |
| Waterproof grade | IP67 | | | |
| Length/Reel | 5050mm 16.56ft | | | |
| Color temperature | ● 2700K | ● 3000K | ● 4000K | ○ 6000K |
| Lumens | 130lm/m 40lm/ft | 150lm/m 46lm/ft | 160lm/m 49lm/ft | 160lm/m 49lm/ft |

Note: 'x' (CCT) = "27"(2700K) / "30"(3000K) / "40"(4000K) / "50"(5000K) / "60"(6000K), Please contact us for more information.

Dimension

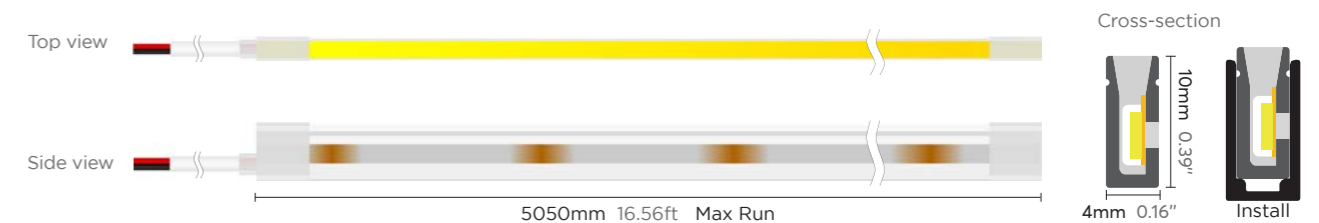

* Please contact our sales for the latest details and certifications

Mini NEON

 Top bending

6x6mm

WHITE

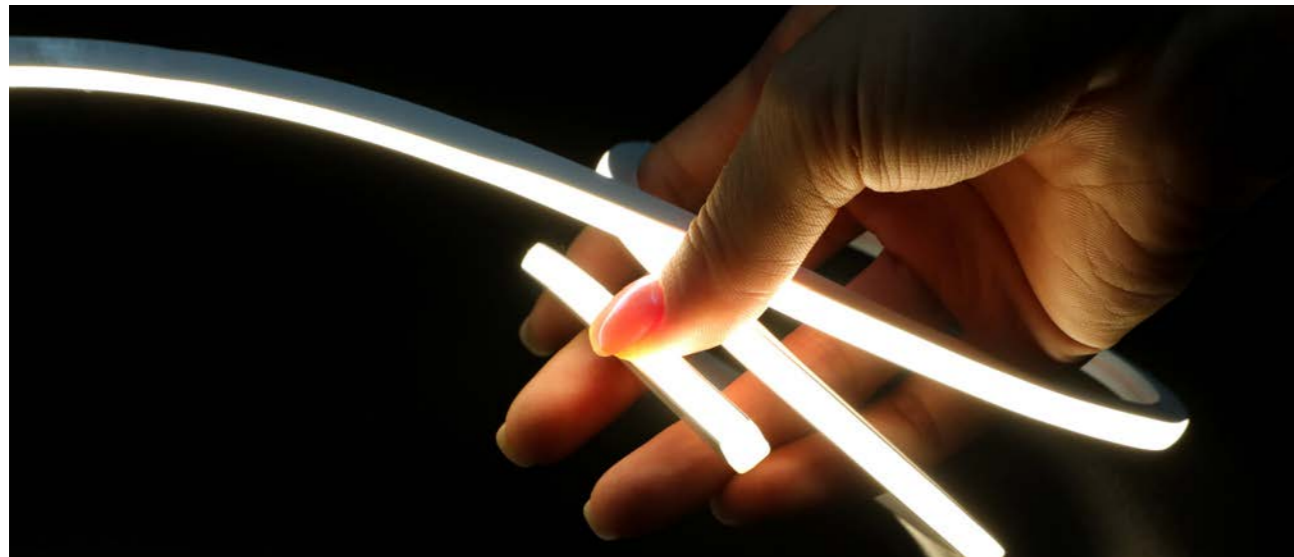

Extrusion process, lights soft and uniform.
6mm wide with ultra narrow output.
Robust housing with high quality silicon.
UV proof for true outdoor application.
Mini cutting 25mm, Cut-able for flexible application.

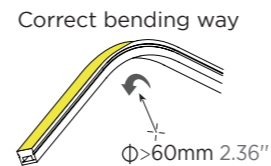

Accessories

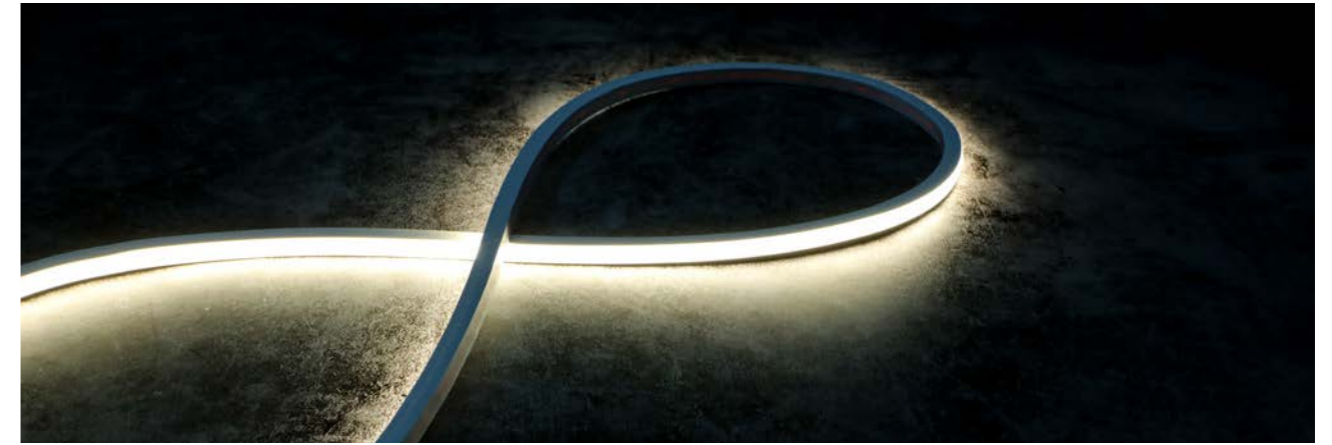

2700K 3000K 4000K 6000K

Technical Details 6x6mm White 8W

| | | | | |
|-------------------|------------------------|---------------------|---------------------|---------------------|
| Product NO. | AU060608WW-24VCLM-MINI | | | |
| Voltage | DC24V | | | |
| Power | 8W/M 2.43W/ft | | | |
| CRI | 90 (2216LEDs) | | | |
| Led Qty | 240LEDs/M 73LEDs/ft | | | |
| Cutting Length | 25mm 0.98" | | | |
| Waterproof grade | IP67 | | | |
| Length/Reel | 5050mm 16.56ft | | | |
| Color temperature | ● 2700K | ● 3000K | ● 4000K | ○ 6000K |
| Lumens | 400lm/m 122lm/ft | 424lm/m 129lm/ft | 464lm/m 141lm/ft | 464lm/m 141lm/ft |

Note: 'x' (CCT) = "27"(2700K) / "30"(3000K) / "40"(4000K) / "50"(5000K) / "60"(6000K), Please contact us for more information.

Dimension



※ Please contact our sales for the latest details and certifications

Mini NEON

Top bending

10x10mm

WHITE / RGB



Three-sided luminous, wide angle, uniform light, dot free.
 Top emitting, meet a variety of top bending light shape.
 IP67, achieve temporary immersion.
 With high quality silicon, UV proof for outdoor application.
 Easy installation with clips and bendable track. Cut-able for flexible application.

Correct bending way

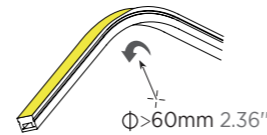

Accessories

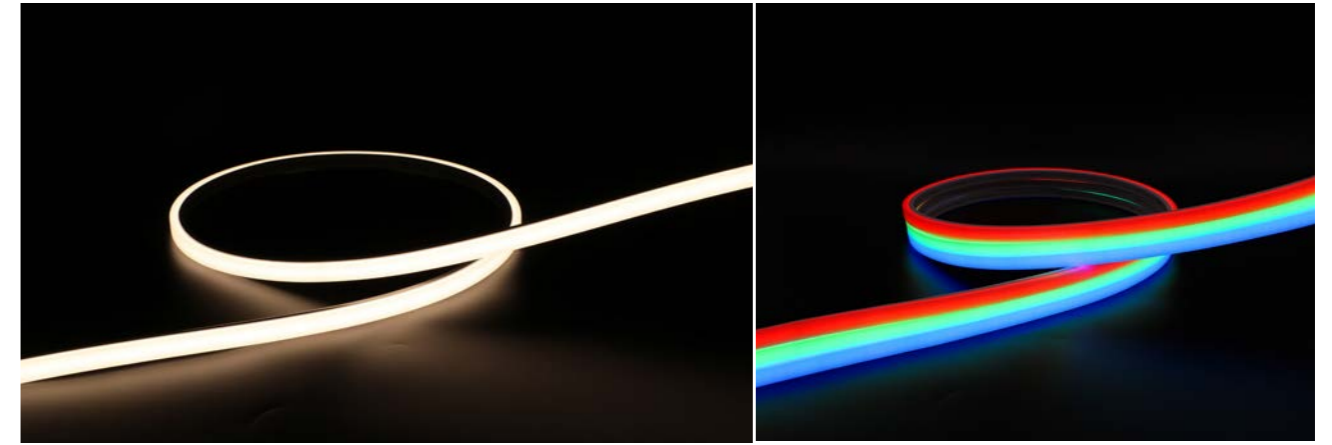

2700K 3000K 4000K 6000K



Technical Details 10x10mm White 14W

| | |
|-------------------|---|
| Product NO. | AU101014WW-24VCLM-MINI |
| Voltage | DC24V |
| Power | 14W/M 4.26W/ft |
| CRI | 90 (2835LEDs) |
| Led Qty | 182LEDs/M 55LEDs/ft |
| Cutting Length | 38.5mm 1.51" |
| Waterproof grade | IP67 |
| Length/Reel | 5050mm 16.56ft |
| Color temperature | ● 2700K ● 3000K ● 4000K ○ 6000K |
| Lumens | 1305lm/m 398lm/ft 1380lm/m 420lm/ft 1380lm/m 420lm/ft 1380lm/m 420lm/ft |

10x10mm RGB 14W

| | |
|-------------------|--|
| Product NO. | AU101014WR-24VCLM-MINI |
| Voltage | DC24V |
| Power | 14W/M 4.26W/ft |
| CRI | - (3838LEDs) |
| Led Qty | 144LEDs/M 43LEDs/ft |
| Cutting Length | 41.7mm 1.64" |
| Waterproof grade | IP67 |
| Length/Reel | 5050mm 16.56ft |
| Color temperature | ● R ● G ● B |
| Lumens | 106lm/m 32lm/ft 302lm/m 92lm/ft 65lm/m 20lm/ft |

Note: 'x' (CCT) = "27"(2700K) / "30"(3000K) / "40"(4000K) / "50"(5000K) / "60"(6000K). Please contact us for more information.

Dimension

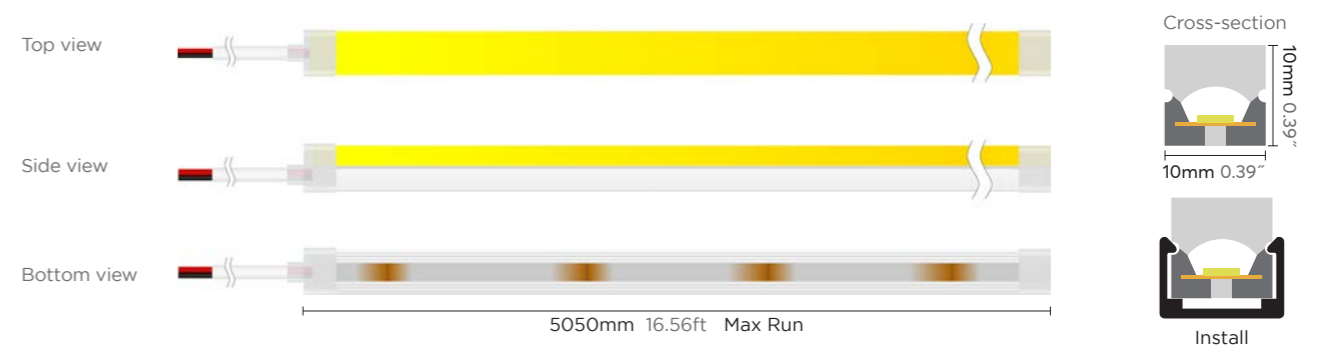

※ Please contact our sales for the latest details and certifications

Mini NEON

 Top bending

10x10(V)mm WHITE



Arc light-emitting surface, uniform light
Top emitting, meet a variety of top bending light shape
IP67, achieve temporary immersion
With high quality silicon, UV proof for outdoor application



Accessories

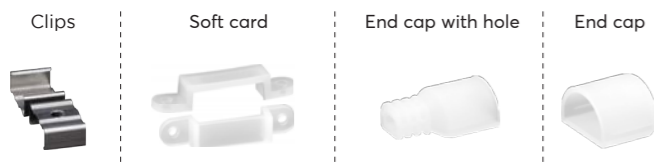

Correct bending way

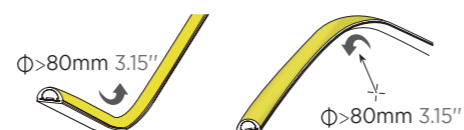

2700K 3000K 4000K 6000K

Technical Details 10x10(V)mm White 10W

| | | | | |
|-------------------|-------------------------|---------------------|---------------------|---------------------|
| Product NO. | AU1010V10WW-24VCLM-MINI | | | |
| Voltage | DC24V | | | |
| Power | 10W/M 3.05W/ft | | | |
| CRI | 90 (2835LEDs) | | | |
| Led Qty | 180LEDs/M 55LEDs/ft | | | |
| Cutting Length | 33.33mm 1.31" | | | |
| Waterproof grade | IP67 | | | |
| Length/Reel | 5050mm 16.56ft | | | |
| Color temperature | ● 2700K | ● 3000K | ● 4000K | ○ 6000K |
| Lumens | 720lm/m 220lm/ft | 760lm/m 232lm/ft | 780lm/m 238lm/ft | 780lm/m 238lm/ft |

Note: 'x' (CCT) = "27"(2700K) / "30"(3000K) / "40"(4000K) / "50"(5000K) / "60"(6000K). Please contact us for more information.

Dimension

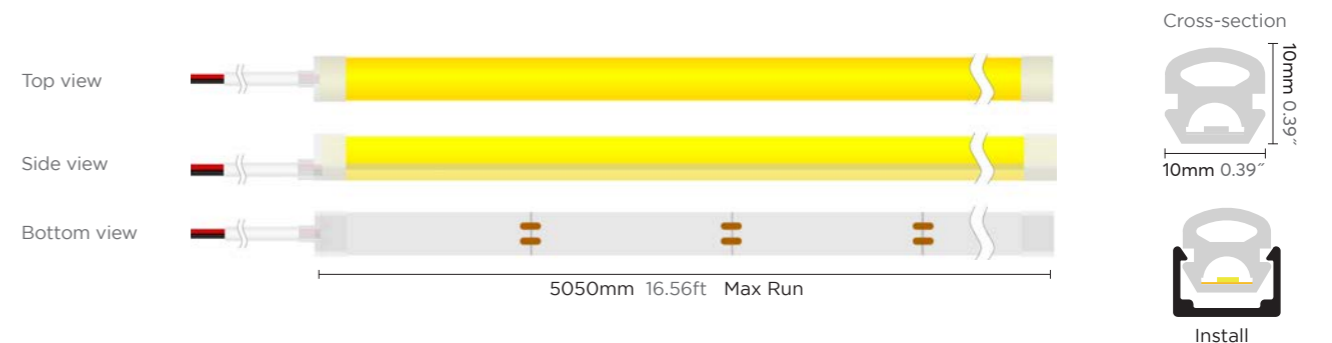

※ Please contact our sales for the latest details and certifications

IP68 NEON



IP68



IK08



More safer

The product has a water-repellent rating of IP68.
Equipped with a 2835 LED light source that is
both bright and energy-efficient.

IP68 NEON

10x18mm White

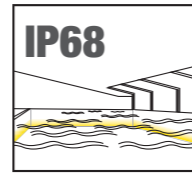

NEON SERIES · IP68 NEON

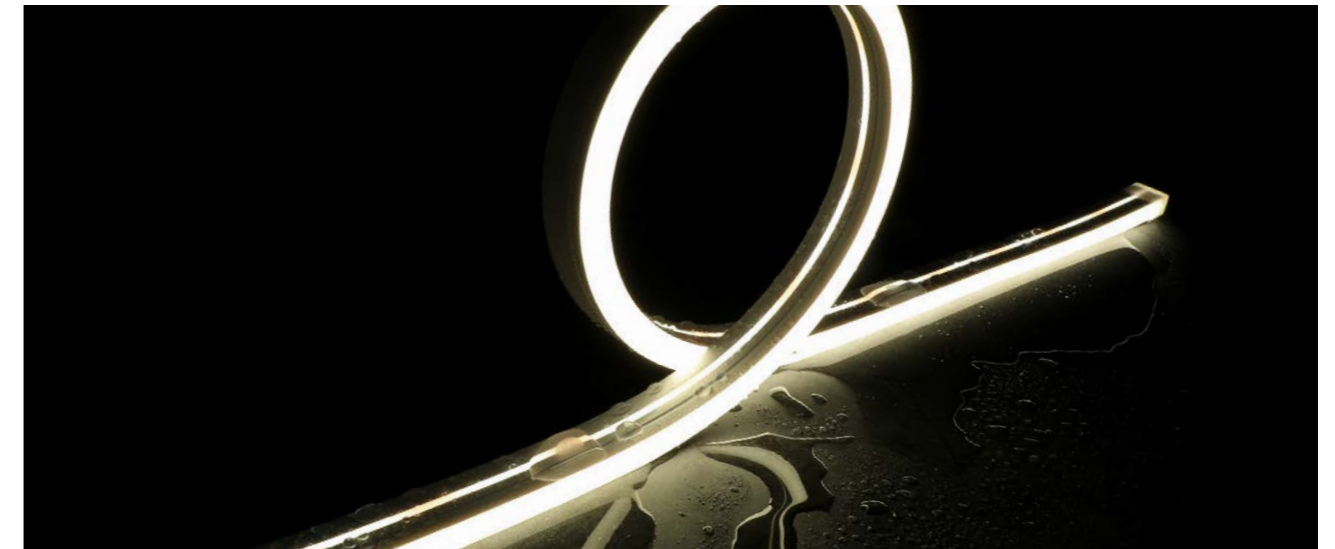

2700K 3000K 4000K 6000K



IP68 10x18mm / Side Bending

Technical Details

| | | | |
|-------------------|----------------------|------------------|-----------------------------------|
| Product NO. | AU101814WW-24VCLM-68 | | |
| Voltage | DC24V | | |
| Power | 14W/M 4.39W/ft | | |
| CRI | 90 (2835LEDs) | | |
| Led Qty | 120LEDs/M 37LEDs/ft | | |
| Cutting Length | 50mm 1.97" | | |
| Waterproof grade | IP68 | | |
| Length/Reel | 5m 16.56ft | | |
| Color temperature | ● 2700K | ● 3000K | ● 4000K ○ 6000K |
| Lumens | 520lm/m 159lm/ft | 578lm/m 176lm/ft | 590lm/m 180lm/ft 605lm/m 184lm/ft |

Note: 'x' (CCT) = "27"(2700K) / "30"(3000K) / "40"(4000K) / "50"(5000K) / "60"(6000K), Please contact us for more information.

NEON SERIES · IP68 NEON

Accessories



Correct bending way

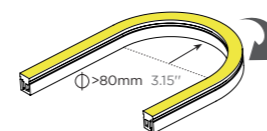

Dimension

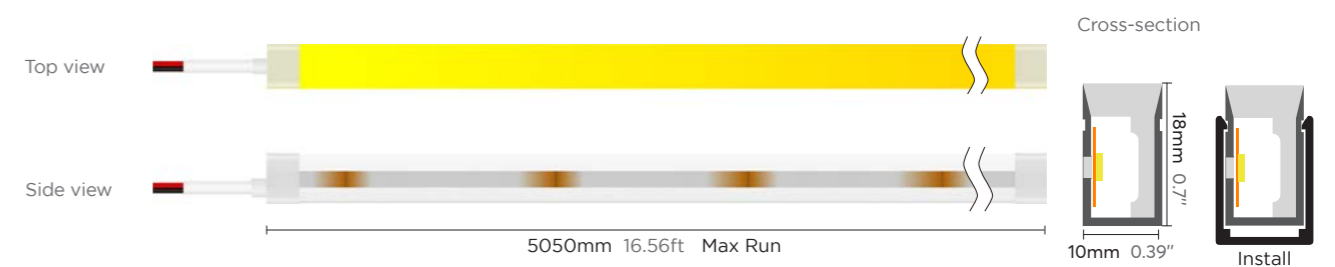

※ Please contact our sales for the latest details and certifications

IP68 NEON

12x20mm DMX RGBW

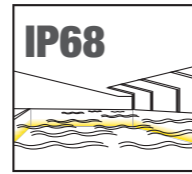

NEON SERIES · IP68 NEON

NEON SERIES · IP68 NEON

Accessories



Correct bending way

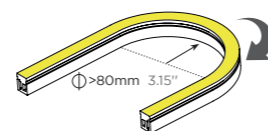

2700K 3000K 4000K 6000K



IP68 12x20mm / Side Bending

Technical Details

| | | | | |
|-------------------|----------------------|-------------------|------------------|--------------------|
| Product NO. | AU122014WR-24VCLM-68 | | | |
| Voltage | DC24V | | | |
| Power | 14W/M 4.39W/ft | | | |
| CRI | 90 (5050LEDs) | | | |
| Led Qty | 70LEDs/M 21LEDs/ft | | | |
| Cutting Length | 100mm 3.94" | | | |
| Waterproof grade | IP68 | | | |
| Length/Reel | 5m 16.56ft | | | |
| Color temperature | ● R | ● G | ● B | ● 4000K |
| Lumens | 45lm/m 14lm/ft | 138lm/m 42m/ft | 26lm/m 8lm/ft | 113lm/m 34lm/ft |

Note: 'x' (CCT) = "27"(2700K) / "30"(3000K) / "40"(4000K) / "50"(5000K) / "60"(6000K), Please contact us for more information.

Dimension

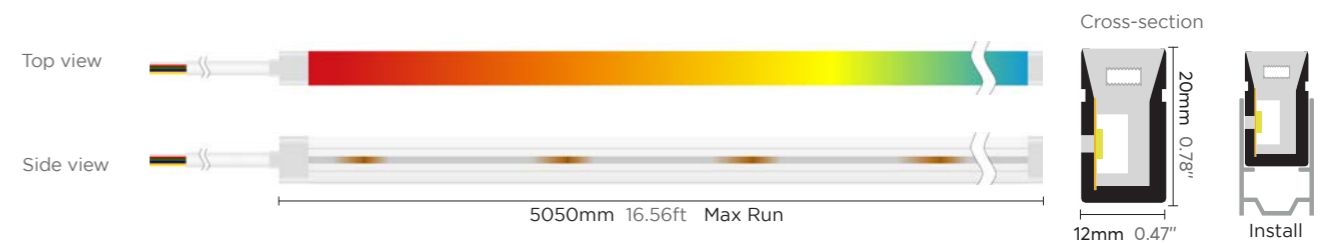

※ Please contact our sales for the latest details and certifications

IP68 NEON

16x16mm White

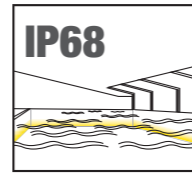

NEON SERIES · IP68 NEON

Accessories

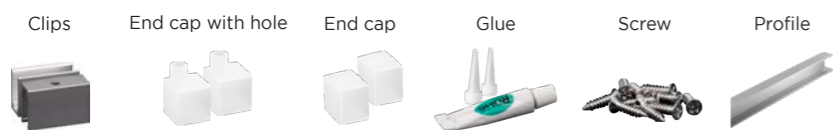

Correct bending way

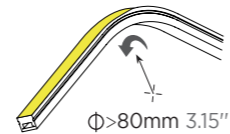

2700K 3000K 4000K 6000K



IP68 16x16mm / Top Bending

Technical Details

| | | | |
|-------------------|--|-----------------------------|---|
| Product NO. | AU161614WW-24VCLM-68 | | |
| Voltage | DC24V | | |
| Power | 14W/M 4.39W/ft | | |
| CRI | 90 (2835LEDs) | | |
| Led Qty | 120LEDs/M 37LEDs/ft | | |
| Cutting Length | 50mm 1.97" | | |
| Waterproof grade | IP68 | | |
| Length/Reel | 5m 16.56ft | | |
| Color temperature | <input checked="" type="radio"/> 2700K | <input type="radio"/> 3000K | <input type="radio"/> 4000K <input type="radio"/> 6000K |
| Lumens | 600lm/m 183lm/ft | 645lm/m 197lm/ft | 685lm/m 209lm/ft 985lm/m 209lm/ft |

Note: 'x' (CCT) = °27°(2700K) / °30°(3000K) / °40°(4000K) / °50°(5000K) / °60°(6000K), Please contact us for more information.

Dimension



* Please contact our sales for the latest details and certifications

NEON SERIES · IP68 NEON

IP68 NEON

20x18mm DMX RGBW

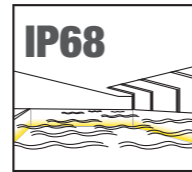

NEON SERIES · IP68 NEON

Accessories



Correct bending way

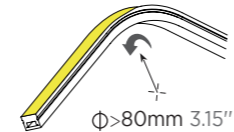

2700K 3000K 4000K 6000K



IP68 20x18mm / Side Bending

Technical Details

| | | | | |
|-------------------|--------------------------------------|--|---------------------------------------|---|
| Product NO. | AU201816WR-24VCLM-68 | | | |
| Voltage | DC24V | | | |
| Power | 16W/M 4.87W/ft | | | |
| CRI | 90 (5050LEDs) | | | |
| Led Qty | 70LEDs/M 21LEDs/ft | | | |
| Cutting Length | 100mm 3.94" | | | |
| Waterproof grade | IP68 | | | |
| Length/Reel | 5m 16.56ft | | | |
| Color temperature | ● R | ● G | ● B | ● 4000K |
| Lumens | 65lm/m 19lm/ft | 177lm/m 44m/ft | 37lm/m 11lm/ft | 170lm/m 52lm/ft |

Note: 'x' (CCT) = "27"(2700K) / "30"(3000K) / "40"(4000K) / "50"(5000K) / "60"(6000K), Please contact us for more information.

Dimension

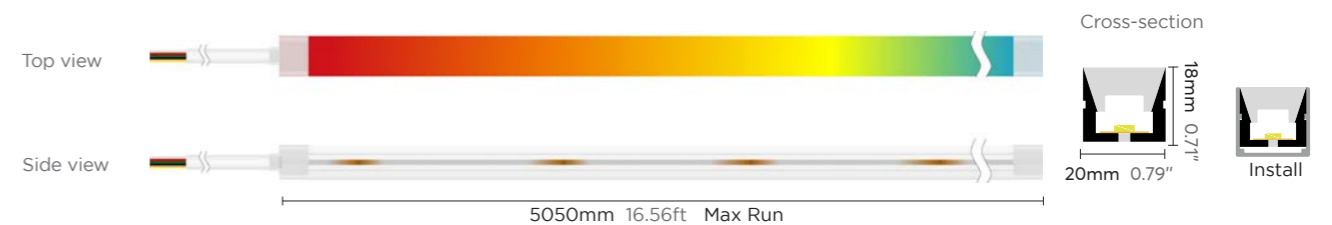

※ Please contact our sales for the latest details and certifications

NEON SERIES · IP68 NEON

IP68 NEON

16x17mm White

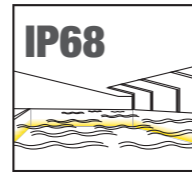

Accessories



IP68 16x17mm / Top Bending



IP68 16x17mm / Side Bending



Technical Details

| Product NO. | AU161712WW-24VCLM-68T | AU161712WW-24VCLM-68S |
|-------------------|---|---|
| Voltage | DC24V | DC24V |
| Power | 12W/M 3.65W/ft | 12W/M 3.65W/ft |
| CRI | 90 (2835LEDs) | 90 (2835LEDs) |
| Led Qty | 120LEDs/M 36LEDs/ft | 120LEDs/M 36LEDs/ft |
| Cutting Length | 100mm 3.93" | 100mm 3.93" |
| Waterproof grade | IP68 | IP68 |
| Length/Reel | 10m 32.8ft | 10m 32.8ft |
| Color temperature | ● 2700K ● 3000K ● 4000K ○ 6000K | ● 2700K ● 3000K ● 4000K ○ 6000K |
| Lumens | 650lm/m 198lm/ft 650lm/m 198lm/ft 700lm/m 213lm/ft 720lm/m 219lm/ft | 500lm/m 152lm/ft 600lm/m 183lm/ft 650lm/m 198lm/ft 650lm/m 198lm/ft |

Note: 'x' (CCT) = "27"(2700K) / "30"(3000K) / "40"(4000K) / "50"(5000K) / "60"(6000K), Please contact us for more information.

Dimension



Cross-section



* Please contact our sales for the latest details and certifications

Long-Run NEON



Side bending

Up to 20m

10x18mm

White



10mm light-emitting surface, uniform light, dot free.
 White Side emitting, meet a variety of side bending light shape.
 IP67, achieve temporary immersion.
 With high quality silicon, UV proof for outdoor application.

Correct bending way

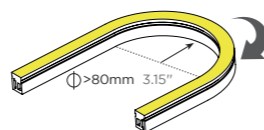

2700K 3000K 4000K 6000K

Technical Details **10x18mm White 14W**

| | | | | |
|-------------------|---------------------------------|----------|----------|----------|
| Product NO. | AU101814WW-24VCLM-LRN | | | |
| Voltage | DC24V | | | |
| Power | 14.4W/M 4.39W/ft | | | |
| CRI | 90 (2835LEDs) | | | |
| Led Qty | 140LEDs/M 42LEDs/ft | | | |
| Cutting Length | 50mm 1.97" | | | |
| Waterproof grade | IP67 | | | |
| Length/Reel | 20m 65.62ft | | | |
| Color temperature | ● 2700K ● 3000K ● 4000K ○ 6000K | | | |
| Lumens | 560lm/m | 565lm/m | 565lm/m | 565lm/m |
| | 170lm/ft | 172lm/ft | 172lm/ft | 172lm/ft |

Note: 'x' (CCT) = "27"(2700K) / "30"(3000K) / "40"(4000K) / "50"(5000K) / "60"(6000K), Please contact us for more information.

Dimension

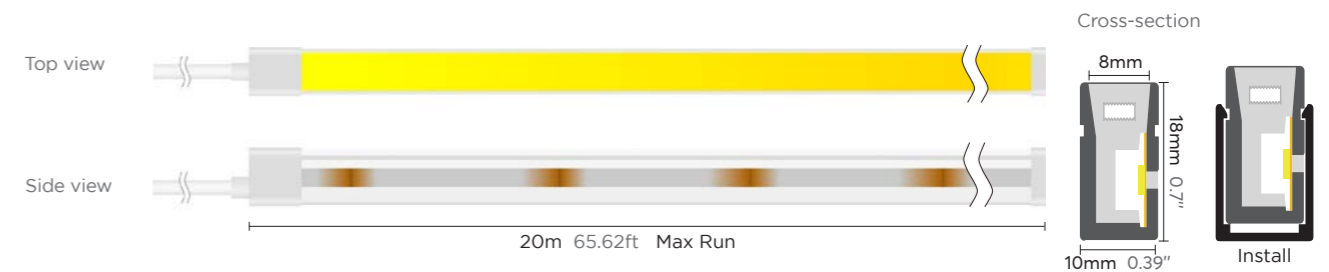

* Please contact our sales for the latest details and certifications

Accessories



Long-Run NEON



Top bending

Up to 20m

16x16mm

White / SPI RGBW



Ultra-Long, up to 20m.

Seamless and uniform light output, dot free, bendable at horizontal direction.

IP67 protection, robust housing with high quality silicon, uv proof for true outdoor application.

Single power supply 20 meters, easy to connect and install.



Correct bending way

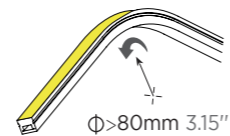

Accessories



2700K 3000K 4000K 6000K

RGBW

Technical Details 16x16mm White 15W 20M

| | |
|-------------------|---|
| Product NO. | AU161615WW-24VCLM-LRN |
| Voltage | DC24V |
| Power | 15W/M 4.57W/ft |
| CRI | 90 (2835LEDs) |
| Led Qty | 140LEDs/M 42LEDs/ft |
| Cutting Length | 50mm 1.97" |
| Waterproof grade | IP67 |
| Length/Reel | 20m 65.6ft |
| Color temperature | ● 2700K ● 3000K ● 4000K ○ 6000K |
| Lumens | 920lm/m 280lm/ft 980lm/m 298lm/ft 1050lm/m 320lm/ft 1000lm/m 305lm/ft |

16x16mm SPI RGBW 12W 20M

| | |
|-------------------|--|
| Product NO. | AU161612WR-24VCLM-LRN |
| Voltage | DC24V |
| Power | 12W/M 3.65W/ft |
| CRI | 80 (5050LEDs) |
| Led Qty | 80LEDs/M 24LEDs/ft |
| Cutting Length | 125mm 4.92" |
| Waterproof grade | IP67 |
| Length/Reel | 20m 65.6ft |
| Color temperature | ● R ● G ● B ● 4000K |
| Lumens | 63lm/m 19lm/ft 214lm/m 65lm/ft 51lm/m 15lm/ft 342lm/m 104lm/ft |

Note: 'x' (CCT) = "27"(2700K) / "30"(3000K) / "40"(4000K) / "50"(5000K) / "60"(6000K), Please contact us for more information.

Dimension

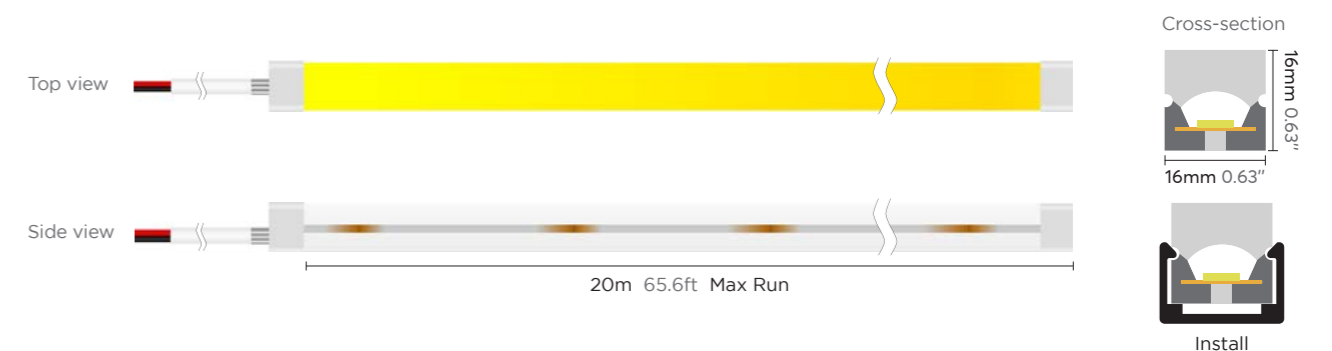



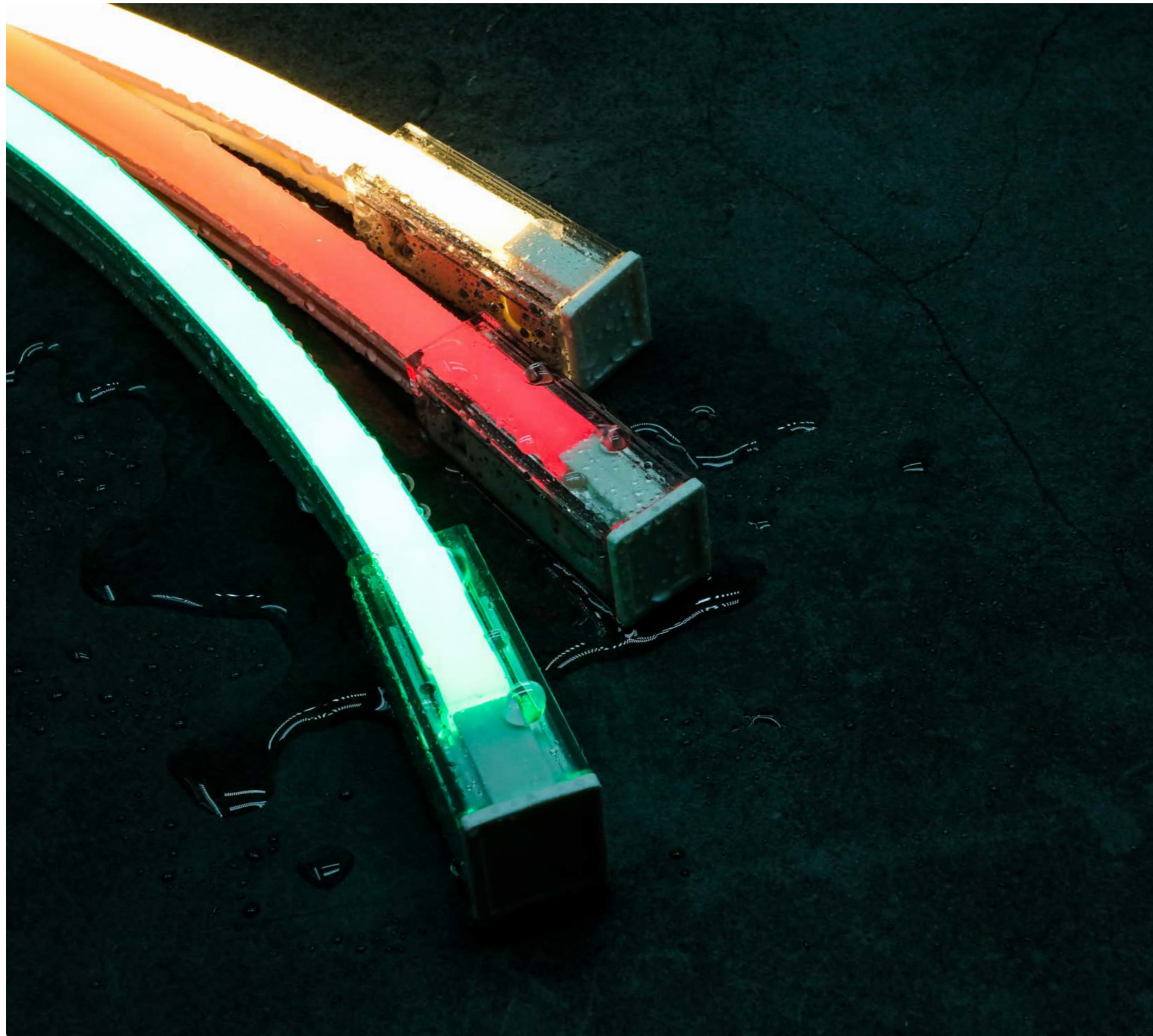



* Please contact our sales for the latest details and certifications







NEON Accessories

Connector

| | | |
|---|--|---------------|
|  | Forward-wiring connector kit Single color | 804A-01-0185U |
|  | Left-wiring connector kit Single color | 804A-01-0186U |
|  | Forward-wiring connector kit Dual color | 804A-01-0187U |
|  | Left-wiring connector kit Dual color | 804A-01-0188U |
|  | Forward-wiring connector kit RGB | 804A-01-0189U |
|  | Left-wiring connector kit RGB | 804A-01-0190U |
|  | End-capping kit | 804A-01-0184U |





Cap

| | | |
|---|-----------------------|----------------|
|  | End cap with hole | 723A-0507-092U |
|  | End cap | 723A-0507-093U |
|  | Bottom-wiring end cap | 723A-0507-096U |
|  | Input cap | 723A-0507-028U |

Clips

| | | |
|---|-------|----------------|
|  | Clips | 701A-0112-341U |
|---|-------|----------------|

Profile

| | | |
|---|------------|-------------------|
|  | M Profile | 913A-01-1299-011U |
|  | 2M | 913A-01-1299-010U |
|  | 1M Track | 913A-01-0299-006U |
|  | 0.5M Track | 913A-01-0299-007U |

Beam NEON

360° Lighting

Φ18mm White / 11W

Φ23mm White / 14W

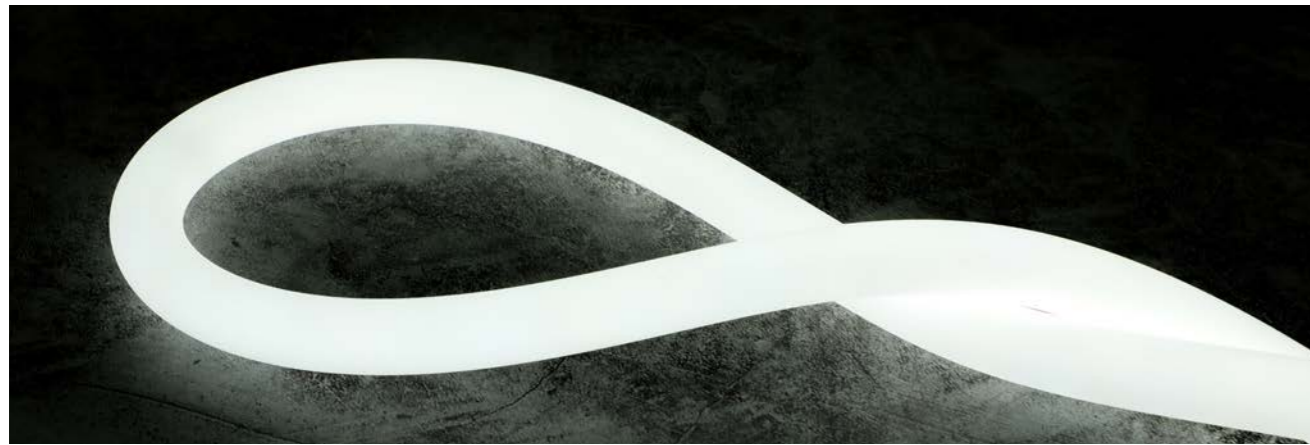

Matte oil material used on the surface, with excellent wear resistance, no dust, Soft and smooth feel of hand touch.

360° lighting, surface illuminate uniformly without any dark area.

It can be bent freely, with superior flexibility & wide application.

IP65, environmental-friendly silicone material, salt and alkali resistant, UV resistant, flame retardant.



Accessories

Clips



Feeder cap

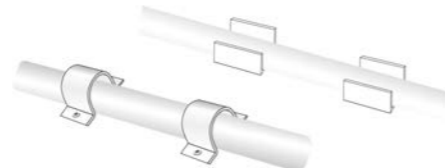

* Please contact us for more product accessories.

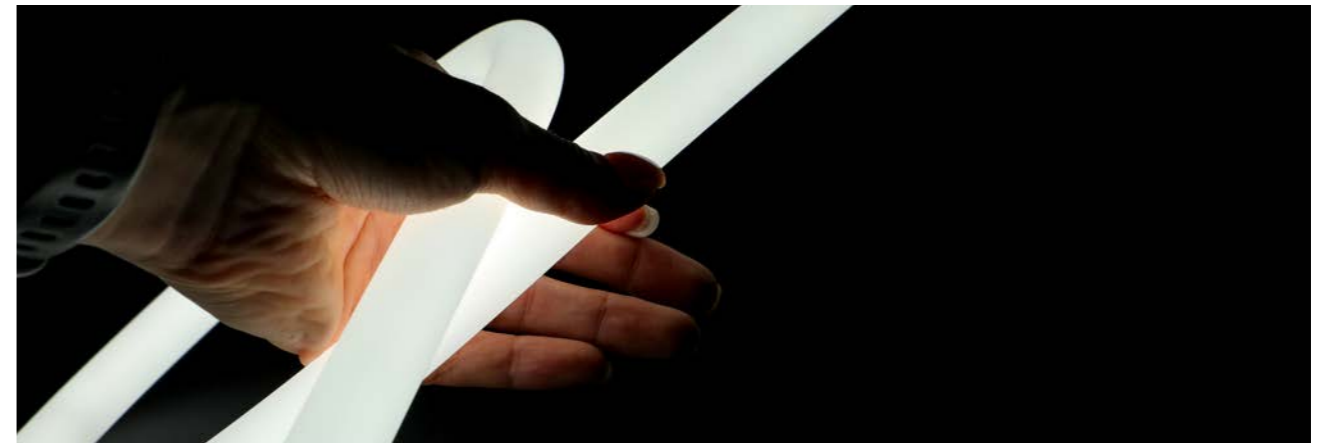

2700K 3000K 4000K 6000K

Technical Details

Φ18mm 11W White

Φ23mm 14W White

| | | | | | | | | |
|-------------------|---|---|------------------|------------------|------------------|------------------|-------------------|-------------------|
| Product NO. | AU001811WW-24VCLM | AU002314WW-24VCLM | | | | | | |
| Voltage | DC24V | DC24V | | | | | | |
| Power | 11W/M 3.35W/ft | 14W/M 4.27W/ft | | | | | | |
| CRI | 90 (2835LEDs) | 90 (2835LEDs) | | | | | | |
| Led Qty | 360LEDs/M 109LEDs/ft | 280LEDs/M 85LEDs/ft | | | | | | |
| Cutting Length | Arbitrarily Cutting | Arbitrarily Cutting | | | | | | |
| Waterproof grade | IP65 | IP65 | | | | | | |
| Diameter | 18mm 0.7" | 23mm 0.9" | | | | | | |
| Color temperature | ● 2700K ● 3000K ● 4000K ○ 6000K | ● 2700K ● 3000K ● 4000K ○ 6000K | | | | | | |
| Lumens | 740lm/m 225lm/ft | 770lm/m 234lm/ft | 780lm/m 237lm/ft | 780lm/m 237lm/ft | 950lm/m 290lm/ft | 990lm/m 302lm/ft | 1000lm/m 305lm/ft | 1000lm/m 305lm/ft |

Note: 'x' (CCT) = *27*(2700K) / *30*(3000K) / *40*(4000K) / *50*(5000K) / *60*(6000K), Please contact us for more information.

Dimension

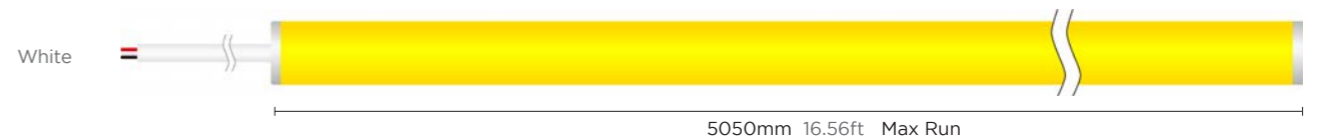

18mm (0.7") Diameter

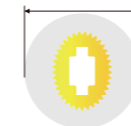

23mm (0.9") Diameter

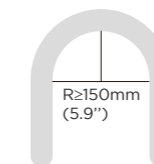
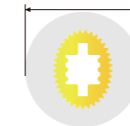

* Please contact our sales for the latest details and certifications

Beam NEON

360° Lighting

Φ23mm / RGB

Φ23mm / SPI



Matte oil material used on the surface, with excellent wear resistance, no dust, Soft and smooth feel of hand touch.

360° lighting, surface illuminate uniformly without any dark area.

It can be bent freely, with superior flexibility & wide application.

IP65, environmental-friendly silicone material, salt and alkali resistant, UV resistant, flame retardant.



Accessories

Clips



Feeder cap

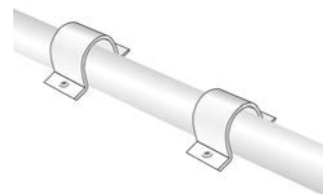

* Please contact us for more product accessories.



| Technical Details | Φ18mm 18W RGB | Φ23mm 16W RGB SPI | | | | |
|-------------------|---------------------|---------------------|-------------------|--------------------|---------------------|-------------------|
| Product NO. | AU001818WR-24VCLM | AU002316WR-24VCLM | | | | |
| Voltage | DC24V | DC24V | | | | |
| Power | 18W/M 5.49W/ft | 16W/M 4.89W/ft | | | | |
| CRI | / (3838LEDs) | / (5050LEDs) | | | | |
| Led Qty | 240LEDs/M 73LEDs/ft | 168LEDs/M 51LEDs/ft | | | | |
| Cutting Length | Arbitrarily Cutting | Arbitrarily Cutting | | | | |
| Waterproof grade | IP65 | IP65 | | | | |
| Diameter | 23mm 0.9" | 23mm 0.9" | | | | |
| Color temperature | ●R ●G ●B | ●R ●G ●B | | | | |
| Lumens | 140lm/m 43lm/ft | 370lm/m 113lm/ft | 75lm/m 23lm/ft | 133lm/m 41lm/ft | 350lm/m 107lm/ft | 60lm/m 18lm/ft |

Note: 'x' (CCT) = *27*(2700K) / *30*(3000K) / *40*(4000K) / *50*(5000K) / *60*(6000K), Please contact us for more information.

Dimension

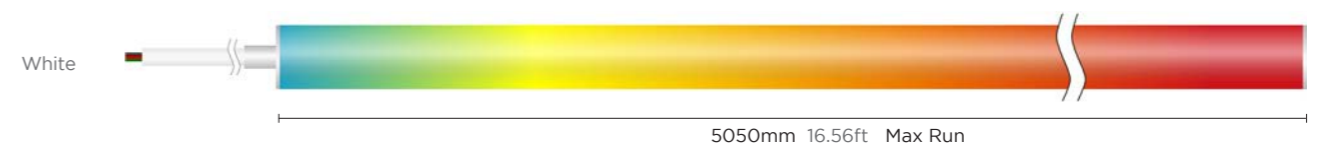

23mm (0.9") Diameter

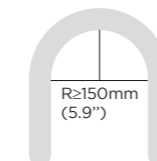
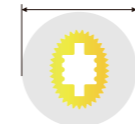

* Please contact our sales for the latest details and certifications

Beam NEON

Spotless Lighting/White 60x100°

Uniform illumination, better cost-effectiveness.



Correct bending way

Top bending

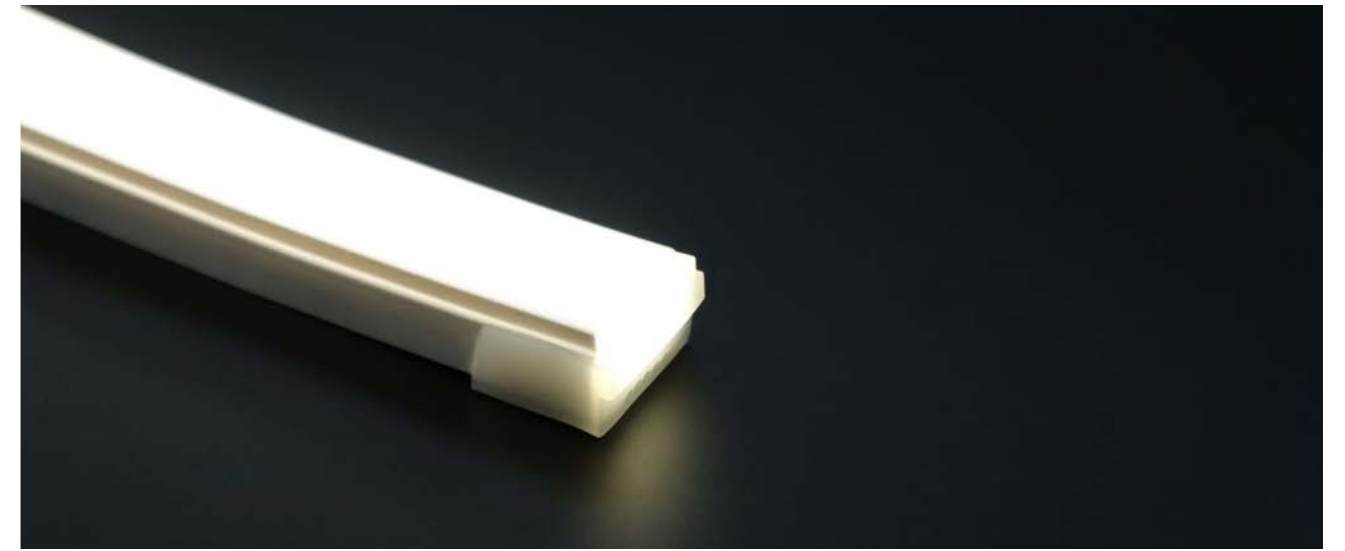
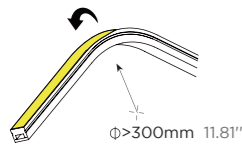

2700K 3000K 4000K 6000K

24x20mm 19W

Technical Details Product NO. AU6010019WW-24VCLM

| | | |
|-------------------------|--------------------|-------------------|
| Voltage | DC24V | |
| Power | 19.2W/M 5.85W/ft | |
| CRI | 90 (2835LEDs) | |
| Led Qty | 60LEDs/M 18LEDs/ft | |
| Cutting Length | 100mm 3.93" | |
| Waterproof grade | IP65 | |
| Length/Reel | 5020mm 16.46ft | |
| Lumens | 60x100° | |
| | ● 2700K | 1535lm/m 468lm/ft |
| | ● 3000K | 1575lm/m 480lm/ft |
| | ● 4000K | 1700lm/m 518lm/ft |
| | ○ 6000K | 1700lm/m 518lm/ft |

Note: 'x' (CCT) = *27*(2700K) / *30*(3000K) / *40*(4000K) / *50*(5000K) / *60*(6000K), Please contact us for more information.

Dimension

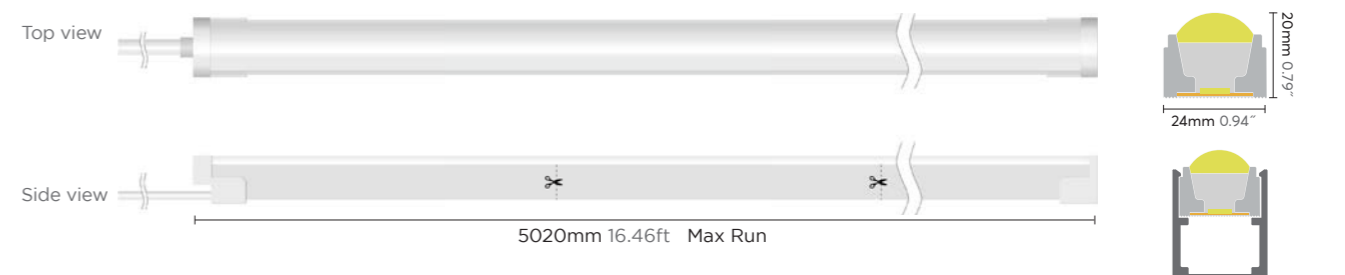

* Please contact our sales for the latest details and certifications



3D Bending NEON

8x8mm

Top&side bending integrated

Mini size, 8x8mm, More free bending and Twist-able
 High efficacy 2216 Plus LED inside.
 UV and yellowish resistant, IP67 and salt-mist proof.
 Easy installation.



NEON SERIES · 3D BENDING

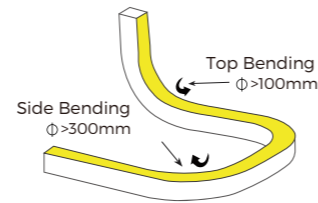

Accessories



Technical Details 8X8mm Free cut

| Product NO. | AU080848WW-24VCLM-FC | AU080848WW-24VCLM-MC |
|-------------------|---|---|
| Voltage | DC24V | DC24V |
| Power | 4.8W/M 1.46W/ft | 4.8W/M 1.46W/ft |
| CRI | 90(2216LEDs) | 90(2216LEDs) |
| Led Qty | 238LEDs/M 73LEDs/ft | 120LEDs/M 36LEDs/ft |
| Cutting Length | Free cut | 29.4mm 1.16" |
| Waterproof grade | IP67 | IP67 |
| Length/Reel | 5M 16.56ft | 5M 16.56ft |
| Color temperature | ● 2700K ● 3000K ● 4000K ○ 6000K | ● 2700K ● 3000K ● 4000K ○ 6000K |
| Lumens | 330lm/m 101lm/ft 340lm/m 104lm/ft 355lm/m 108lm/ft 355lm/m 108lm/ft | 385lm/m 117lm/ft 390lm/m 119lm/ft 410lm/m 125lm/ft 410lm/m 125lm/ft |

Note: 'x' (CCT) = *27*(2700K) / *30*(3000K) / *40*(4000K) / *50*(5000K) / *60*(6000K), Please contact us for more information.

Dimension

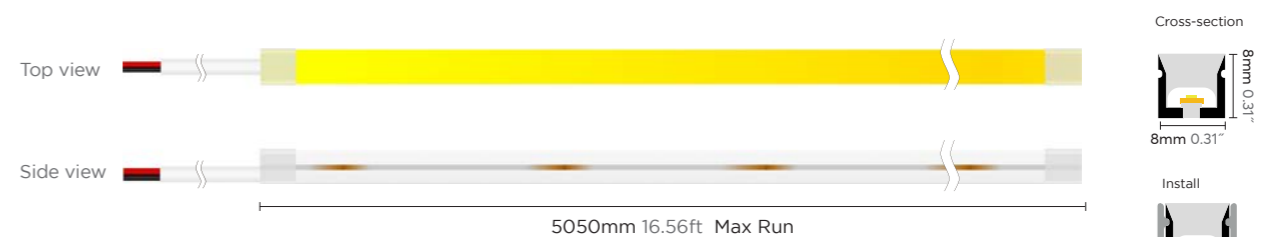

* Please contact our sales for the latest details and certifications

NEON SERIES · 3D BENDING



3D Bending NEON

16x18mm

Top&side bending integrated

Free bending and Twist-able, High efficacy 2835 LED inside.
Dual-color silicone extrusion, UV and yellowish resistant.
IP67 and salt-mist proof.
Easy installation.

Top Bending

Side Bending

NEON SERIES · 3D BENDING

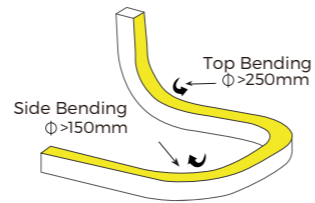

Accessories

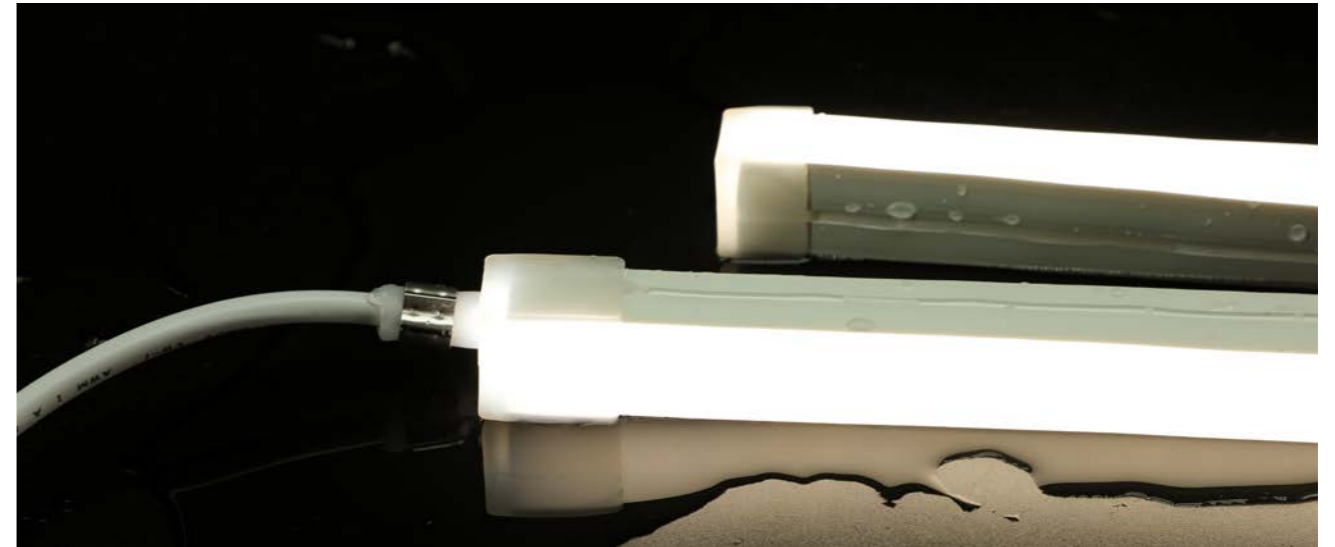

2700K 3000K 4000K 6000K

Technical Details 16X18mm

| | | | | |
|-------------------|----------------------|---------------------|---------------------|---------------------|
| Product NO. | AU161814WW-24VCLM-3D | | | |
| Voltage | DC24V | | | |
| Power | 14W/M 4.27W/ft | | | |
| CRI | 90 (2835LEDs) | | | |
| Led Qty | 120LEDs/M 36LEDs/ft | | | |
| Cutting Length | 25mm 0.98" | | | |
| Waterproof grade | IP67 | | | |
| Length/Reel | 5M 16.56ft | | | |
| Color temperature | ● 2700K | ● 3000K | ● 4000K | ○ 6000K |
| Lumens | 700lm/m 213lm/ft | 740lm/m 225lm/ft | 760lm/m 232lm/ft | 760lm/m 232lm/ft |

Note: 'x' (CCT) = *27*(2700K) / *30*(3000K) / *40*(4000K) / *50*(5000K) / *60*(6000K), Please contact us for more information.

Dimension

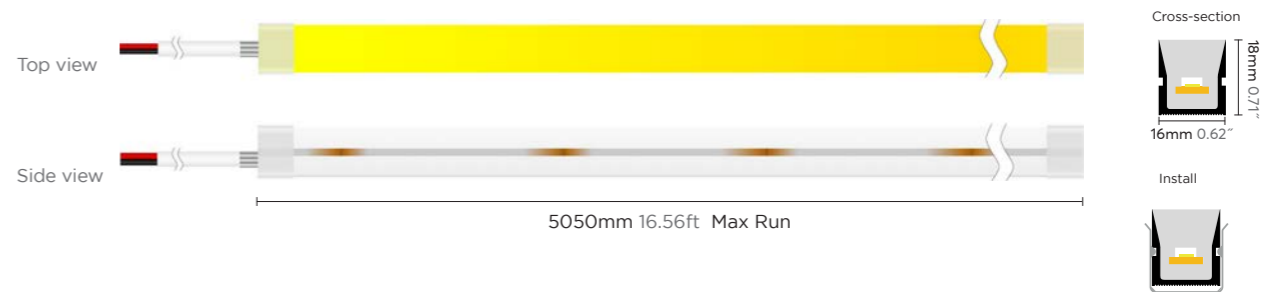

* Please contact our sales for the latest details and certifications

NEON SERIES · 3D BENDING



3D Bending NEON

16x17mm

Top&side bending integrated

Free bending and Twist-able, High efficacy 2835 LED inside.
Dual-color silicone extrusion,UV and yellowish resistant.
IP67 and salt-mist proof.
Easy installation.



NEON SERIES · 3D BENDING

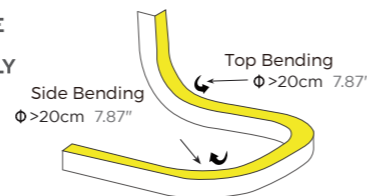

Accessories

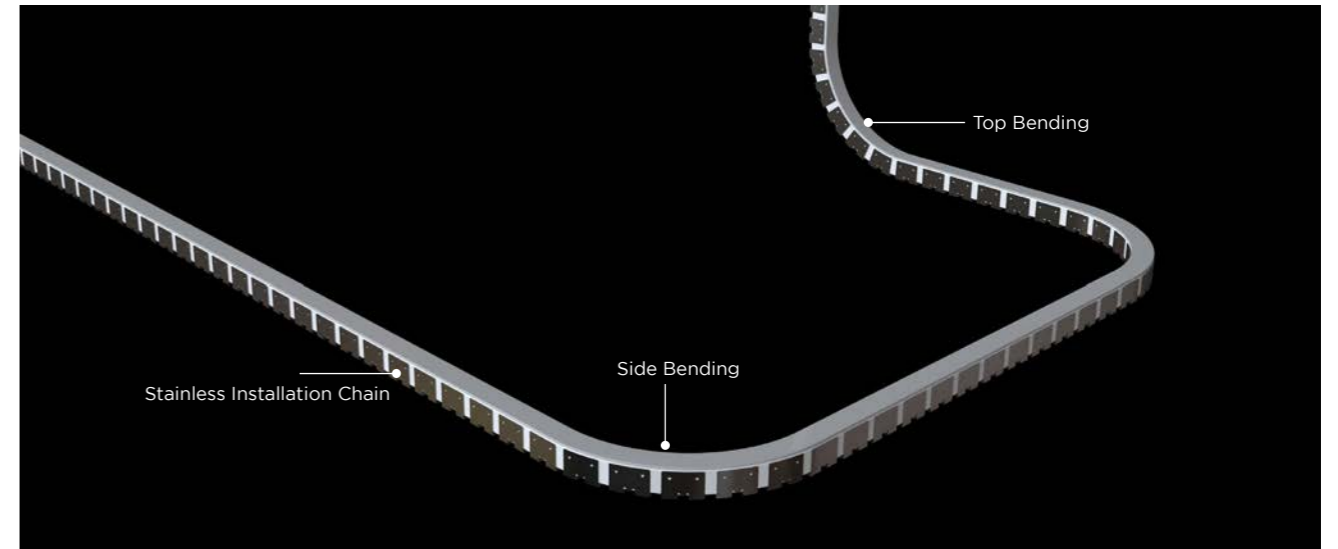

3D Bending 12W / White / 16x17mm

Technical Details

| | | | | |
|-------------------|----------------------|---------------------|---------------------|---------------------|
| Product NO. | AU161712WW-24VCLM-3D | | | |
| Voltage | DC24V | | | |
| Power | 12W/M 3.65W/ft | | | |
| CRI | 90 (2835LEDs) | | | |
| Led Qty | 120LEDs/M 36LEDs/ft | | | |
| Cutting Length | 50mm 1.97" | | | |
| Waterproof grade | IP67 | | | |
| Length/Reel | 10m 32.8ft | | | |
| Color temperature | ● 2700K | ● 3000K | ● 4000K | ○ 6000K |
| Lumens | 600lm/m 183lm/ft | 650lm/m 198lm/ft | 700lm/m 213lm/ft | 700lm/m 213lm/ft |

Note: 'x' (CCT) = *27*(2700K) / *30*(3000K) / *40*(4000K) / *50*(5000K) / *60*(6000K), Please contact us for more information.

Dimension

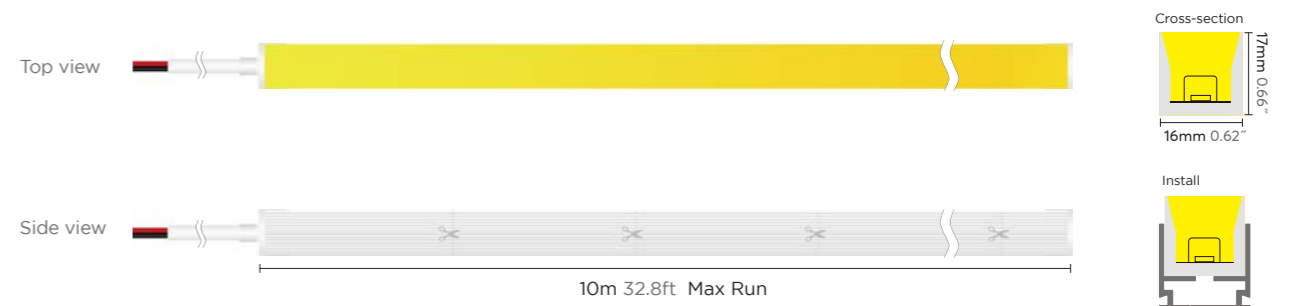

* Please contact our sales for the latest details and certifications

NEON SERIES · 3D BENDING

Digital Colorful NEON

 Top bending

16x15mm RGBW DMX Controlled

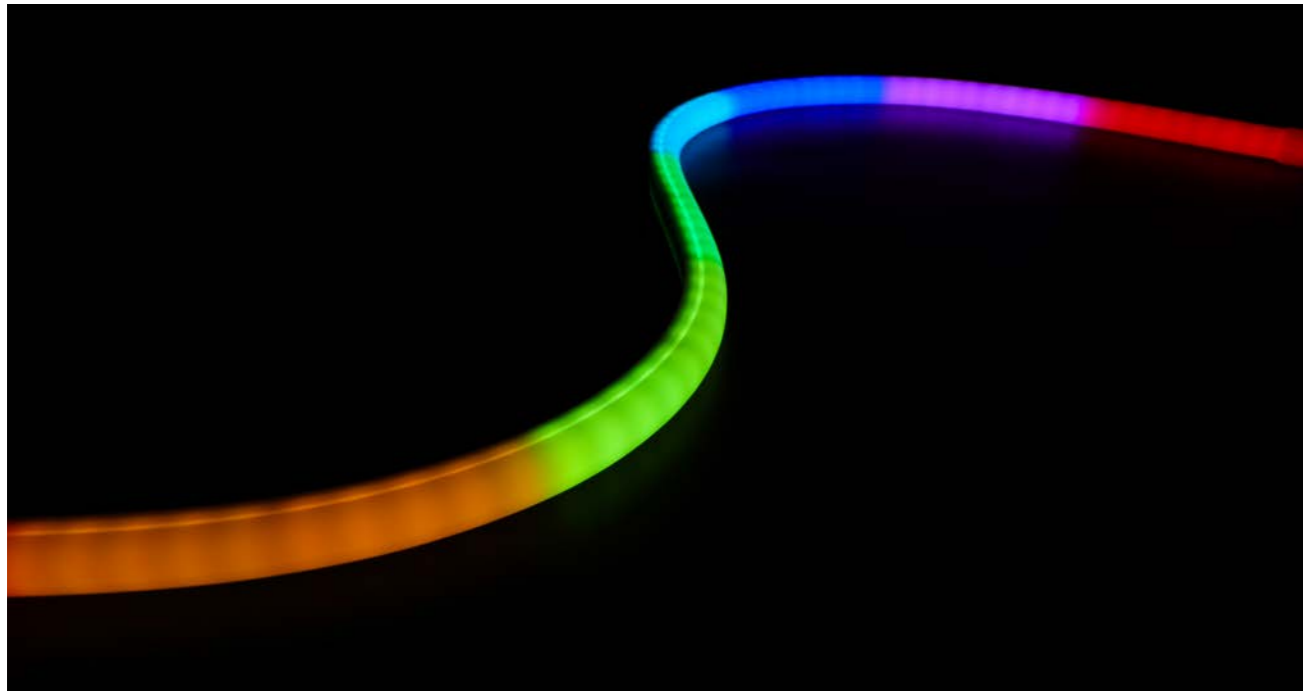

16mm light-emitting surface, uniform light, dot-free.
Arc light-emitting surface, larger light-emitting angle.
IP67, capable of temporary immersion.
Made of high-quality silicon, UV-resistant, suitable for outdoor applications

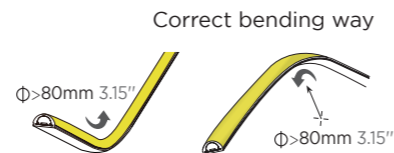

Accessories



Technical Details **16x15mm RGBW DMX 15W**

| | | | | |
|-------------------|------------------------------------|--------------------------------------|-------------------------------------|---|
| Product NO. | AU161515WR-24VCLM-DG | | | |
| Voltage | DC24V | | | |
| Power | 15W/M 4.57W/ft | | | |
| CRI | 80 (5050LEDs) | | | |
| Led Qty | 80LEDs/M 24LEDs/ft | | | |
| Cutting Length | 125mm 4.92" | | | |
| Waterproof grade | IP67 | | | |
| Length/Reel | 5050mm 16.56ft | | | |
| Color temperature | ● R | ● G | ● B | ● 4000K |
| Lumens | 39lm/m 12lm/ft | 112lm/m 34m/ft | 30lm/m 9lm/ft | 138lm/m 42lm/ft |

Note: 'x' (CCT) = "27"(2700K) / "30"(3000K) / "40"(4000K) / "50"(5000K) / "60"(6000K), Please contact us for more information.

Dimension

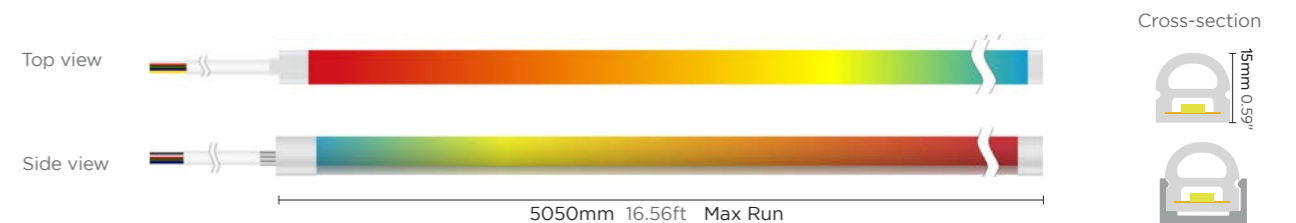

※ Please contact our sales for the latest details and certifications

Digital Colorful NEON

 Top bending

16x16mm RGBW DMX Controlled



Built-in IC/SM18522PS, DMX512 signal protocol, single color, gradient color change, chasing, anima on and scene display.

Correct bending way

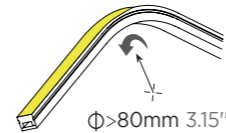

Accessories



Technical Details **16x16mm RGBW 14W**

| | | | | |
|-------------------|------------------------------------|--------------------------------------|-------------------------------------|---|
| Product NO. | AU161614WR-24VCLM-DG | | | |
| Voltage | DC24V | | | |
| Power | 14W/M 4.26W/ft | | | |
| CRI | 80 (5050LEDs) | | | |
| Led Qty | 80LEDs/M 24LEDs/ft | | | |
| Cutting Length | 125mm 4.92" | | | |
| Waterproof grade | IP67 | | | |
| Length/Reel | 5050mm 16.56ft | | | |
| Color temperature | ● R | ● G | ● B | ● 3000K |
| Lumens | 40lm/m 5lm/ft | 128lm/m 39lm/ft | 51lm/m 15lm/ft | 130lm/m 40lm/ft |

Note: 'x' (CCT) = "27"(2700K) / "30"(3000K) / "40"(4000K) / "50"(5000K) / "60"(6000K), Please contact us for more information.

Dimension

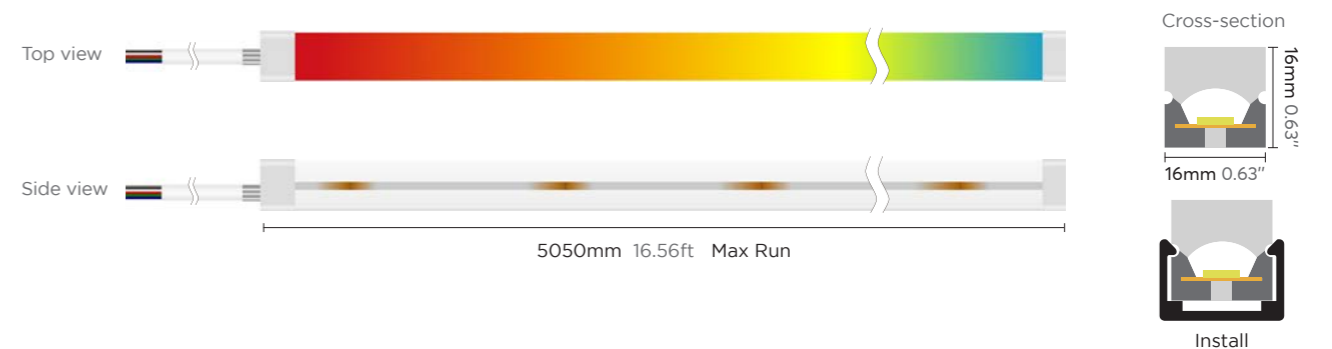

* Please contact our sales for the latest details and certifications

Digital Colorful NEON

 Top bending

16x20mm RGBW DMX Controlled

16mm light-emitting surface, uniform light, dot free.
RGBW Top emitting, meet a variety of side bending light shape.
Extrusion process, IP67, achieve temporary immersion.
With high quality silicon, UV proof for outdoor application.



Accessories



Correct bending way

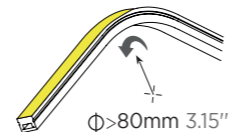

Technical Details **16x20mm DMX Controlled RGBW 15W**

| | | | | |
|-------------------|----------------------|--------------------|-------------------|--------------------|
| Product NO. | AU162015WR-24VCLM-DG | | | |
| Voltage | DC24V | | | |
| Power | 15W/M 4.57W/ft | | | |
| CRI | 90 (5050LEDs) | | | |
| Led Qty | 70LEDs/M 21LEDs/ft | | | |
| Cutting Length | 100mm 3.94" | | | |
| Waterproof grade | IP67 | | | |
| Length/Reel | 5050mm 16.56ft | | | |
| Color temperature | ● R | ● G | ● B | ● 3000K |
| Lumens | 50lm/m 15lm/ft | 130lm/m 40lm/ft | 36lm/m 11lm/ft | 175lm/m 53lm/ft |

Note: 'x' (CCT) = "27"(2700K) / "30"(3000K) / "40"(4000K) / "50"(5000K) / "60"(6000K), Please contact us for more information.

Dimension

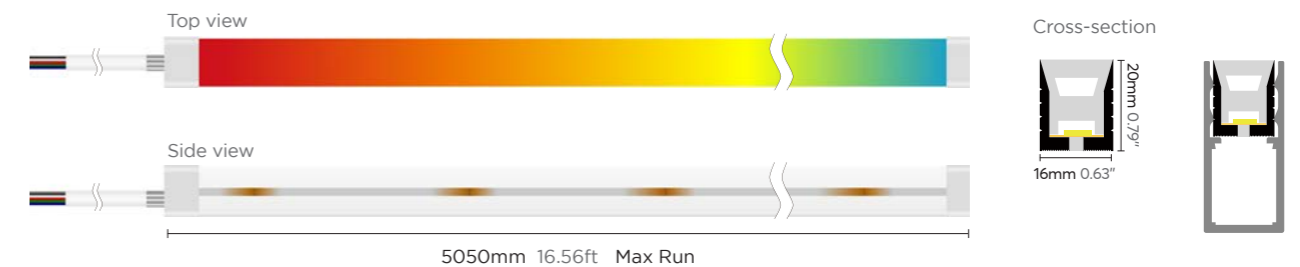

* Please contact our sales for the latest details and certifications

Digital Colorful NEON

 Top bending

25x25mm RGBW DMX Controlled

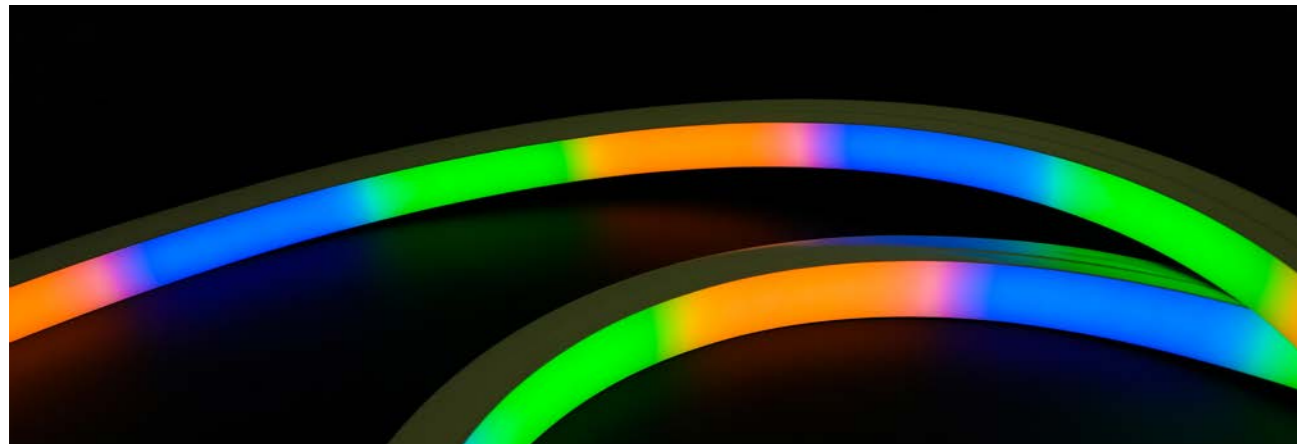

Seamless and uniform light output, dot free.
Built-in IC/SM18522PS, DMX512 signal protocol, single color, gradient color change, chasing, anima on and scene display.
Varying color programs can be controlled by 8 pixels per meter.



Correct bending way

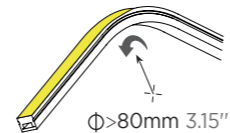

Accessories

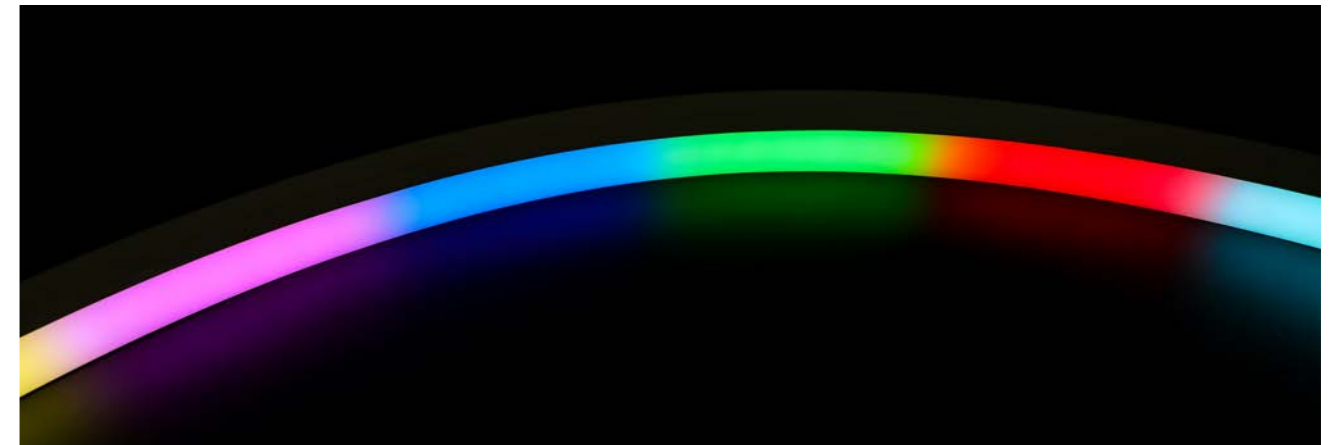

Technical Details **25x25mm RGBW DMX 12W**

| | | | | |
|-------------------|----------------------|---------|--------|---------|
| Product NO. | AU252512WR-24VCLM-DG | | | |
| Voltage | DC24V | | | |
| Power | 12W/M 3.65W/ft | | | |
| CRI | 90 (5050LEDs) | | | |
| Led Qty | 56LEDs/M 17LEDs/ft | | | |
| Cutting Length | 125mm 4.92" | | | |
| Waterproof grade | IP67 | | | |
| Length/Reel | 5050mm 16.56ft | | | |
| Color temperature | ● R | ● G | ● B | ● 3000K |
| Lumens | 30lm/m | 72lm/m | 16lm/m | 93m/m |
| | 9lm/ft | 21lm/ft | 4lm/ft | 28lm/ft |

Note: 'x' (CCT) = "27"(2700K) / "30"(3000K) / "40"(4000K) / "50"(5000K) / "60"(6000K). Please contact us for more information.

Dimension

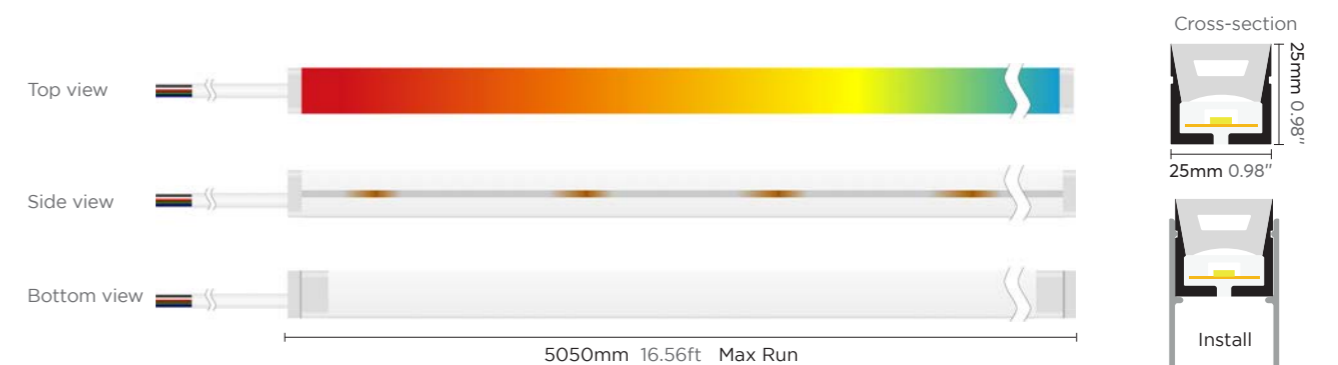

* Please contact our sales for the latest details and certifications

Digital Colorful NEON

 Side bending

10x18mm RGB DMX Controlled

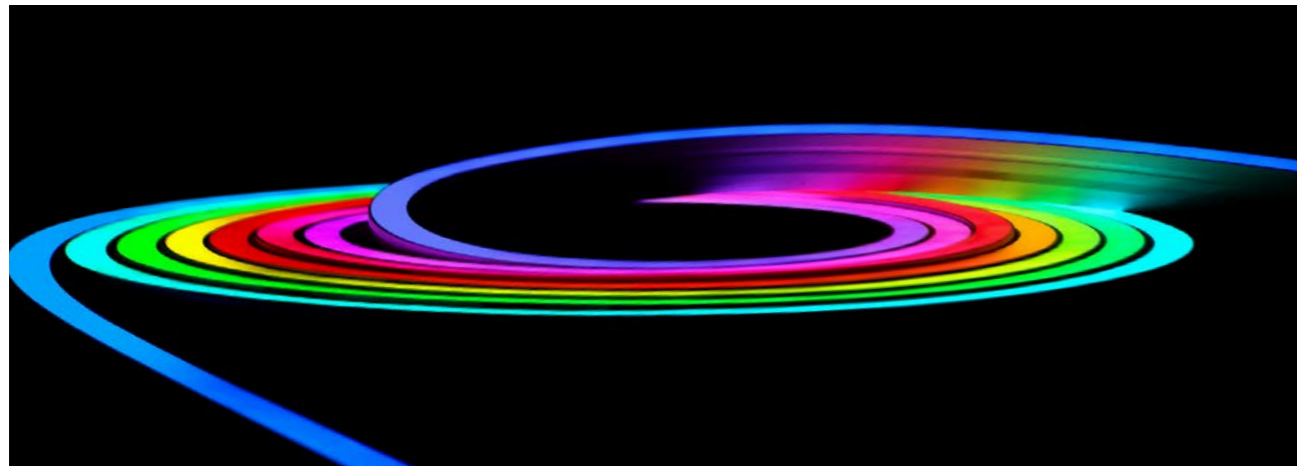

Seamless and uniform light output, dot free, Bendable at horizontal direction.
Built-in IC/SM18522PS, DMX512 signal protocol, single color, gradient color change, chasing, anima on and scene display.
Robust housing with high quality silicon, UV proof for true outdoor application.
Cut-able for flexible application, easy installation with clips and bendable track.



Correct bending way

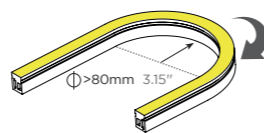

Accessories

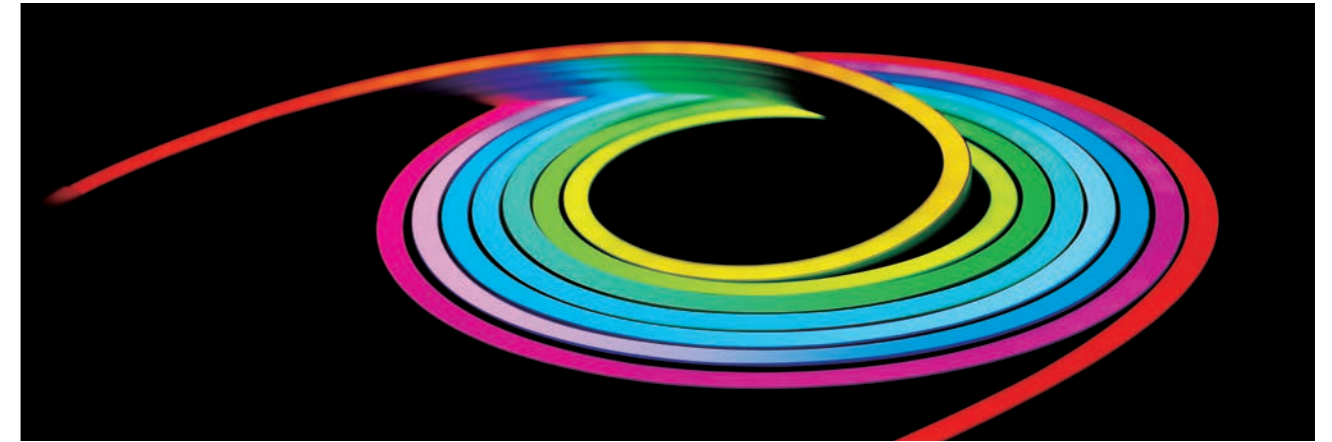

Technical Details **DMX 10x18mm 12W 56LEDs/M** **DMX 10x18mm 14W 60LEDs/M**

| | | | | | | |
|-------------------|----------------------|--------------------|------------------|----------------------|-------------------|------------------|
| Product NO. | AU101812WR-24VCLM-DG | | | AU101814WR-24VCLM-DG | | |
| Voltage | DC24V | | | DC24V | | |
| Power | 12W/M 3.28W/ft | | | 14W/M 4.26W/ft | | |
| CRI | - (5050LEDs) | | | - (5050LEDs) | | |
| Led Qty | 56LEDs/M 17LEDs/ft | | | 60LEDs/M 18LEDs/ft | | |
| Cutting Length | 125mm 4.92" | | | 100mm 3.93" | | |
| Waterproof grade | IP67 | | | IP67 | | |
| Length/Reel | 5050mm 16.56ft | | | 5050mm 16.56ft | | |
| Color temperature | ● R | ● G | ● B | ● R | ● G | ● B |
| Lumens | 45lm/m 13lm/ft | 110lm/m 33lm/ft | 21lm/m 5lm/ft | 38lm/m 11lm/ft | 85lm/m 25lm/ft | 20lm/m 6lm/ft |

Note: 'x' (CCT) = *27*(2700K) / *30*(3000K) / *40*(4000K) / *50*(5000K) / *60*(6000K), Please contact us for more information.

Dimension

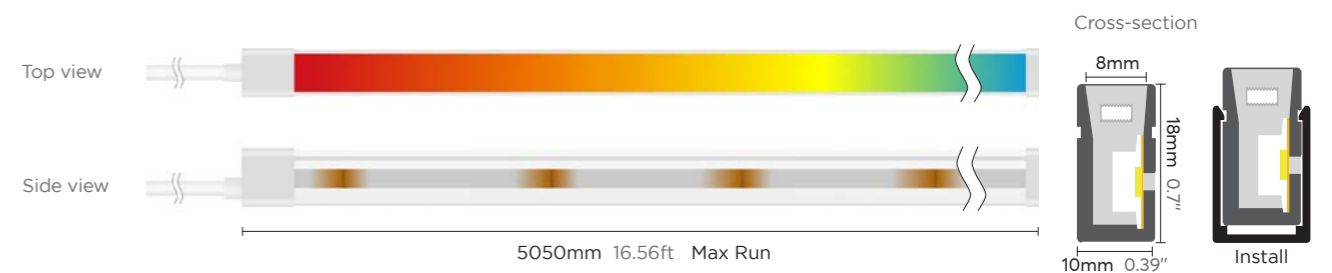

※ Please contact our sales for the latest details and certifications

Digital Colorful NEON

 Side bending

12x20mm RGBW DMX Controlled



Seamless and uniform light output, dot free, Bendable at horizontal direction.
Built-in IC/SM18522PS, DMX512 signal protocol, single color, gradient color change, chasing, anima on and scene display.



Correct bending way

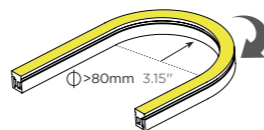

Accessories

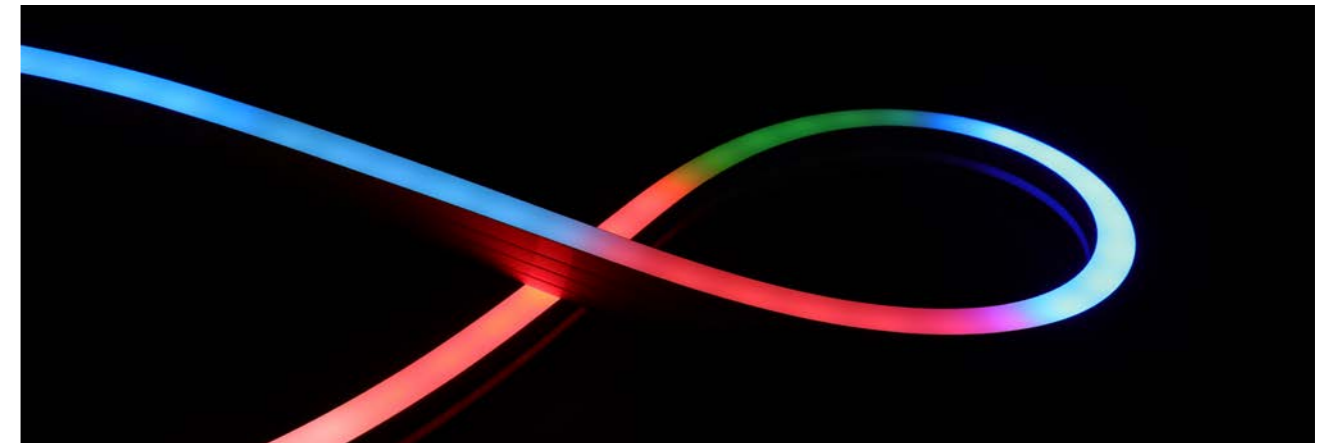

Technical Details 1220 RGBW DMX

| | | | | |
|-------------------|------------------------------------|------------------------------------|------------------------------------|-----------------------------|
| Product NO. | AU122012WR-24VCLM-DG | | | |
| Voltage | DC24V | | | |
| Power | 12W/M 3.28W/ft | | | |
| CRI | 80 (5050LEDs) | | | |
| Led Qty | 56LEDs/M 17LEDs/ft | | | |
| Cutting Length | 100mm 3.93" | | | |
| Waterproof grade | IP67 | | | |
| Length/Reel | 5050mm 16.56ft | | | |
| Color temperature | <input checked="" type="radio"/> R | <input checked="" type="radio"/> G | <input checked="" type="radio"/> B | <input type="radio"/> 6000K |
| Lumens | 25lm/m 8lm/ft | 72lm/m 22m/ft | 22lm/m 7lm/ft | 122lm/m 37lm/ft |

Note: 'x' (CCT) = "27"(2700K) / "30"(3000K) / "40"(4000K) / "50"(5000K) / "60"(6000K), Please contact us for more information.

Dimension

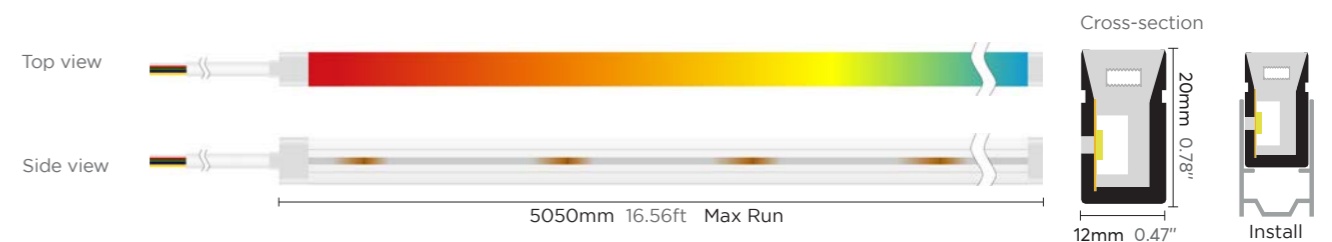

※ Please contact our sales for the latest details and certifications

Digital Colorful NEON

 Side bending

12x25mm RGBW DMX Controlled



12mm light-emitting surface, uniform light, dot free.
Seamless and uniform light output, dot free, Bendable at horizontal direction.
Built-in IC/SM18522PS, DMX512 signal protocol, single color, gradient color change, chasing, anima on and scene display.

Correct bending way



Accessories

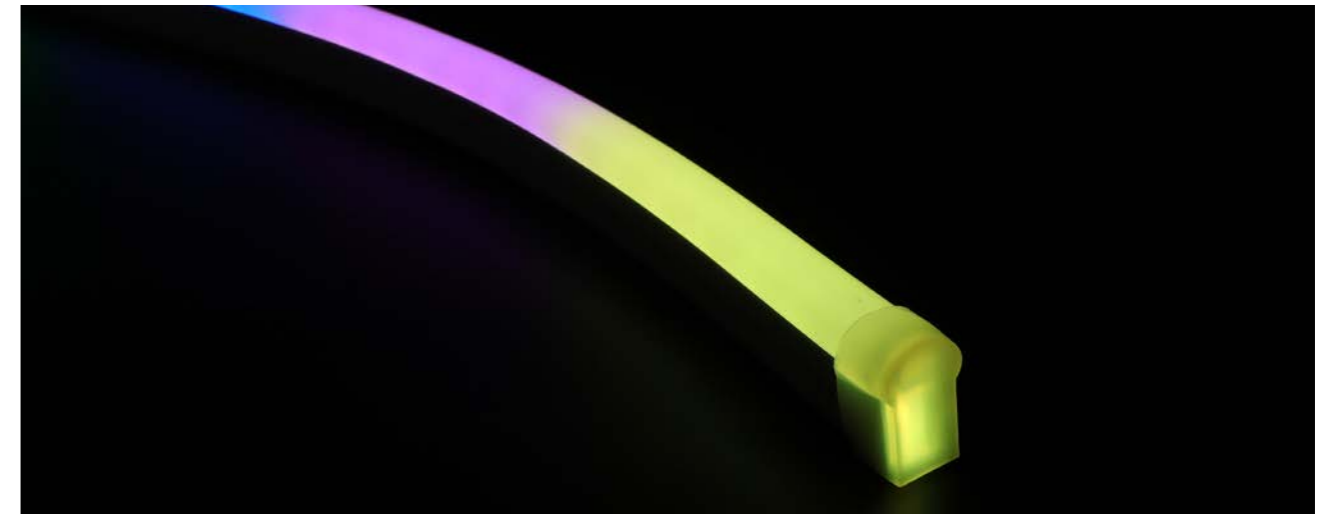

Technical Details 1225 RGBW DMX

| | | | | |
|-------------------|------------------------------------|--------------------------------------|-------------------------------------|---|
| Product NO. | AU122515WR-24VCLM-DG | | | |
| Voltage | DC24V | | | |
| Power | 15W/M 4.57W/ft | | | |
| CRI | 80 (5050LEDs) | | | |
| Led Qty | 56LEDs/M 17LEDs/ft | | | |
| Cutting Length | 50mm 1.97" | | | |
| Waterproof grade | IP67 | | | |
| Length/Reel | 5050mm 16.56ft | | | |
| Color temperature | ● R | ● G | ● B | ○ 6000K |
| Lumens | 43lm/m 13lm/ft | 111lm/m 34m/ft | 25lm/m 8lm/ft | 148lm/m 45lm/ft |

Note: 'x' (CCT) = "27"(2700K) / "30"(3000K) / "40"(4000K) / "50"(5000K) / "60"(6000K), Please contact us for more information.

Dimension



※ Please contact our sales for the latest details and certifications

Digital Colorful NEON

 Side bending

16x20mm RGBW DMX Controlled

16mm light-emitting surface, uniform light, dot free.
RGBW Side emitting, meet a variety of side bending light shape.
Extrusion process, IP67, achieve temporary immersion.
With high quality silicon, UV proof for outdoor application.



Accessories



Correct bending way

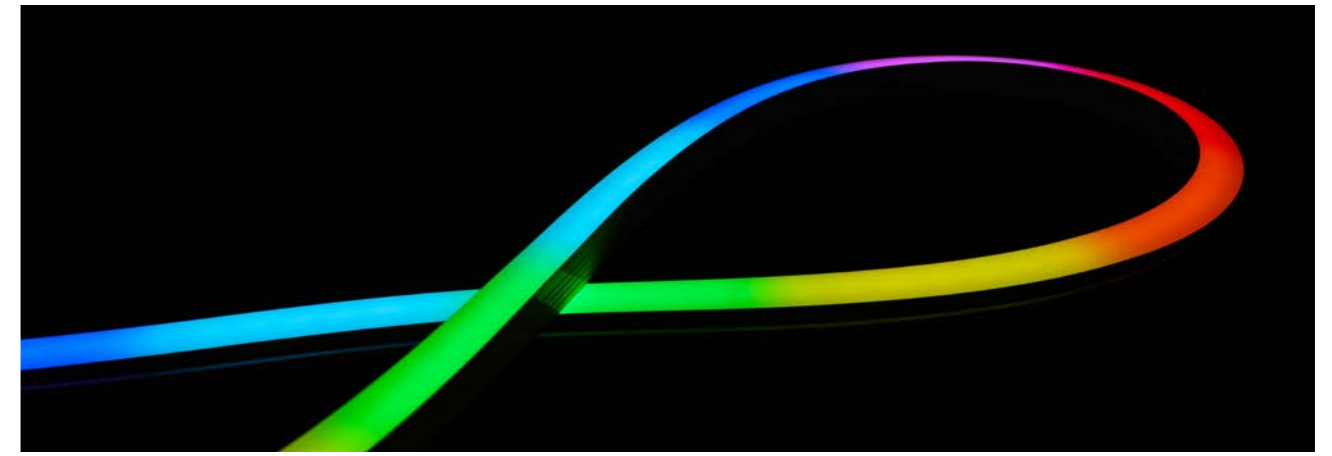
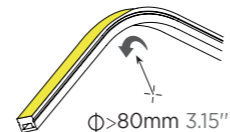

Technical Details **16x20mm DMX Controlled RGBW 15W**

| | | | | |
|-------------------|----------------------|--------------------|------------------|--------------------|
| Product NO. | AU162015WR-24VCLM-DG | | | |
| Voltage | DC24V | | | |
| Power | 15W/M 4.57W/ft | | | |
| CRI | 90 (5050LEDs) | | | |
| Led Qty | 70LEDs/M 21LEDs/ft | | | |
| Cutting Length | 100mm 3.94" | | | |
| Waterproof grade | IP67 | | | |
| Length/Reel | 5050mm 16.56ft | | | |
| Color temperature | ● R | ● G | ● B | ● 3000K |
| Lumens | 45lm/m 14lm/ft | 110lm/m 34lm/ft | 30lm/m 9lm/ft | 120lm/m 36lm/ft |

Note: 'x' (CCT) = "27"(2700K) / "30"(3000K) / "40"(4000K) / "50"(5000K) / "60"(6000K), Please contact us for more information.

Dimension



* Please contact our sales for the latest details and certifications

COB SERIES

COB Honor (24V/12V)

COB Essential

COB Neon

COB Connectors

COB IP Rating





COB Honor/Weldless

320LEDS/M 8W 24V/12V



Product NO. AU320008WW-24VCLM-COB

Technical Details

| Power | 8W/M 2.4W/ft | Lumens | | ErP Class | |
|-------------------------|---------------------|---------|------------------|-----------|--|
| Voltage | DC24V/DC12V | ● 2700K | 745lm/m 227lm/ft | F | |
| CRI | 90 | ● 3000K | 810lm/m 246lm/ft | F | |
| Led Qty | 320LEDs/m 97LEDs/ft | ● 4000K | 840lm/m 256lm/ft | F | |
| Length/Reel | 5004mm 16.41ft | ● 6500K | 840lm/m 256lm/ft | F | |
| Cutting Length | 50mm 1.97" | | | | |
| Waterproof grade | IP20 / IP65 / IP68 | | | | |

Note:'x' (CCT) = "27"(2700K) / "30"(3000K) / "40"(4000K) / "50"(5000K) / "60"(6000K), Please contact us for more information.

Dimension

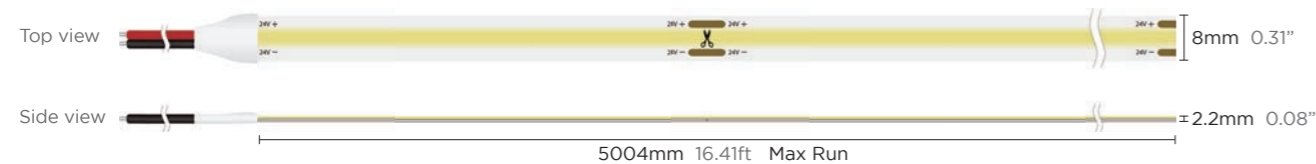

* Please contact our sales for the latest details and certifications

COB SERIES · HONOR



COB Honor/Weldless

400LEDS/M 12W 24V/12V



Product NO. AU400012WW-24VCLM-COB

Technical Details

| Power | 12W/M 3.66W/ft | Lumens | | ErP Class | |
|-------------------------|----------------------|---------|-------------------|-----------|--|
| Voltage | DC24V/DC12V | ● 2700K | 1080lm/m 329lm/ft | G | |
| CRI | 90 | ● 3000K | 1060lm/m 323lm/ft | G | |
| Led Qty | 400LEDs/M 121LEDs/ft | ● 4000K | 1285lm/m 391lm/ft | F | |
| Length/Reel | 5004mm 16.41ft | ● 6500K | 1285lm/m 391lm/ft | F | |
| Cutting Length | 100mm 3.92" | | | | |
| Waterproof grade | IP20 / IP65 / IP68 | | | | |

Note:'x' (CCT) = "27"(2700K) / "30"(3000K) / "40"(4000K) / "50"(5000K) / "60"(6000K), Please contact us for more information.

Dimension

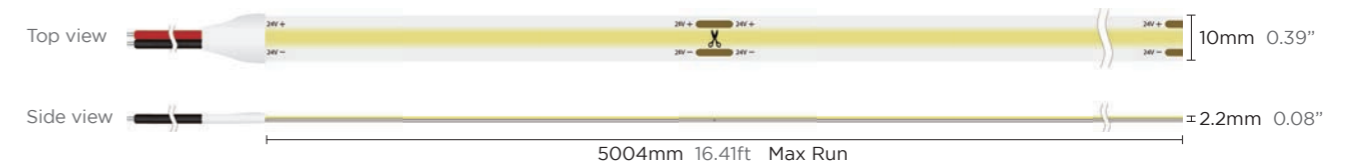

* Please contact our sales for the latest details and certifications

COB SERIES · HONOR



COB Honor/Weldless

480LEDS/M 15W 24V/12V



Product NO. AU480015WW-24VCLM-COB

Technical Details

| Power | 15W/M 4.57W/ft | Lumens | | ErP Class | |
|-------------------------|----------------------|---------|-------------------|-----------|--|
| Voltage | DC24V/DC12V | ● 2700K | 1350lm/m 411lm/ft | G | |
| CRI | 90 | ● 3000K | 1440lm/m 439lm/ft | F | |
| Led Qty | 480LEDs/M 146LEDs/ft | ● 4000K | 1440lm/m 439lm/ft | F | |
| Length/Reel | 5004mm 16.41ft | ● 6500K | 1440lm/m 439lm/ft | F | |
| Cutting Length | 50mm 1.97" | | | | |
| Waterproof grade | IP20 / IP65 / IP68 | | | | |

Note: 'x' (CCT) = "27"(2700K) / "30"(3000K) / "40"(4000K) / "50"(5000K) / "60"(6000K), Please contact us for more information.

Dimension

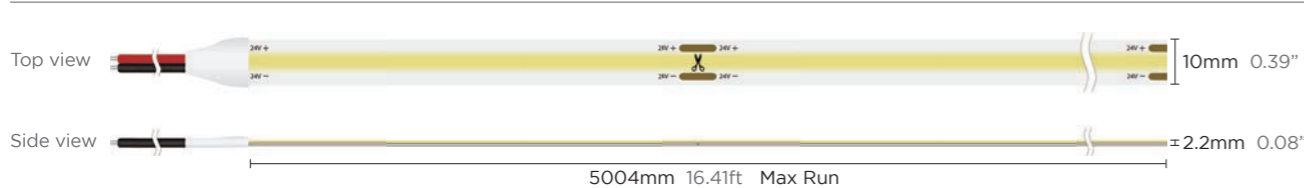

※ Please contact our sales for the latest details and certifications



COB Honor/ Weldless/R/G/B/Y

480LEDS/M 10W 24V



Product NO. AU480010WR-24VCLM-COB

Technical Details

| Power | 10W/M 3.04W/ft | Lumens | | Peak WL | |
|-------------------------|----------------------|--------|-------------------|--------------|--|
| Voltage | DC24V | ● R | 68lm/m 20lm/ft | Lp=660-670nm | |
| CRI | - | ● G | 1180lm/m 359lm/ft | Lp=520-530nm | |
| Led Qty | 480LEDs/M 146LEDs/ft | ● B | 175lm/m 53lm/ft | Lp=455-465nm | |
| Length/Reel | 5004mm 16.41ft | ● Y | 800lm/m 244lm/ft | 1800K | |
| Cutting Length | 50mm 1.97" | | | | |
| Waterproof grade | IP20 / IP65 / IP68 | | | | |

Note: 'x' (CCT) = "27"(2700K) / "30"(3000K) / "40"(4000K) / "50"(5000K) / "60"(6000K), Please contact us for more information.

Dimension

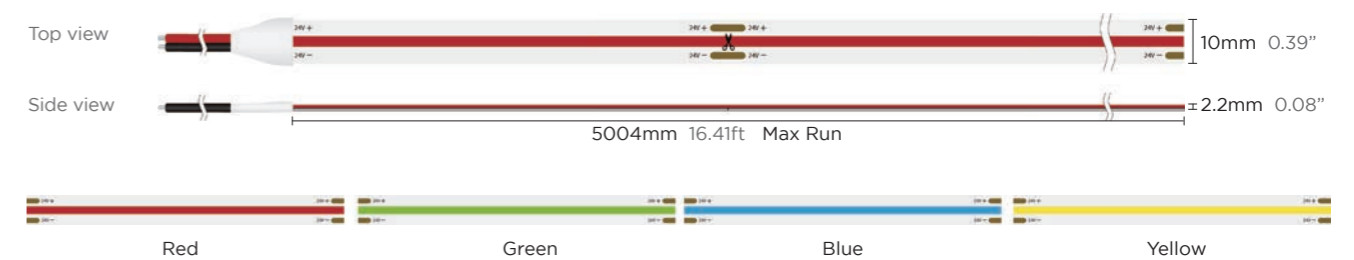

※ Please contact our sales for the latest details and certifications

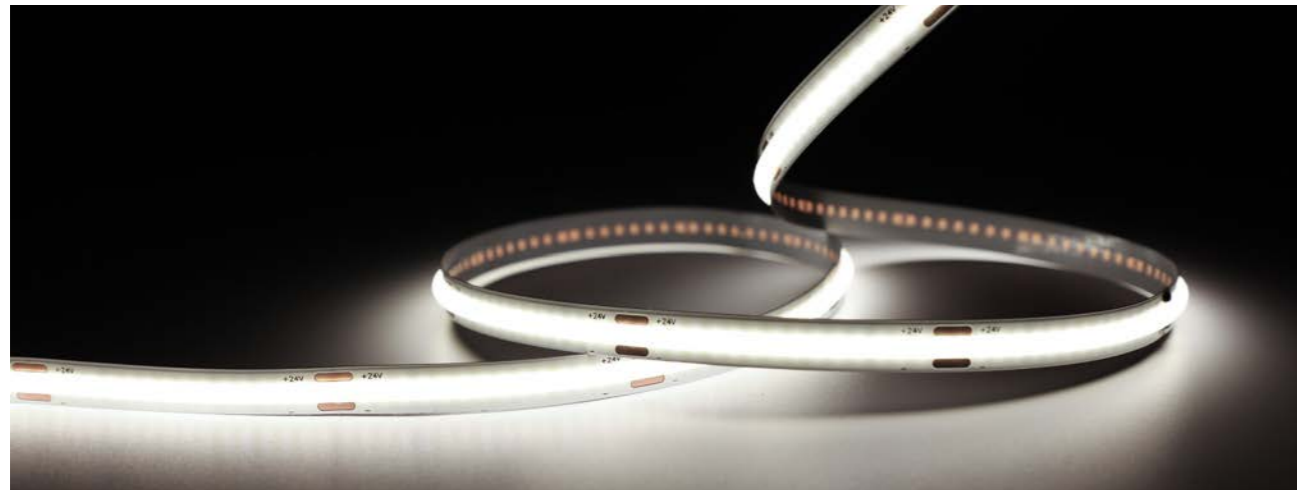

COB Essential/Weldless

320LEDS/M 8W 24V



Product NO. AU320008WW-24VCLM-COB

Technical Details

| Power | 8W/M 2.4W/ft | Lumens | | ErP Class | |
|-------------------------|---------------------|---------|------------------|-----------|----------|
| Voltage | DC24V | ● 2700K | 736lm/m 224lm/ft | | G |
| CRI | 90 | ● 3000K | 760lm/m 231lm/ft | | F |
| Led Qty | 320LEDs/M 97LEDs/ft | ● 4000K | 864lm/m 263lm/ft | | F |
| Length/Reel | 5004mm 16.41ft | ● 6500K | 864lm/m 263lm/ft | | F |
| Cutting Length | 50mm 1.96" | | | | |
| Waterproof grade | IP20 / IP65 / IP68 | | | | |

Note:'x' (CCT) = "27"(2700K) / "30"(3000K) / "40"(4000K) / "50"(5000K) / "60"(6000K), Please contact us for more information.

Dimension

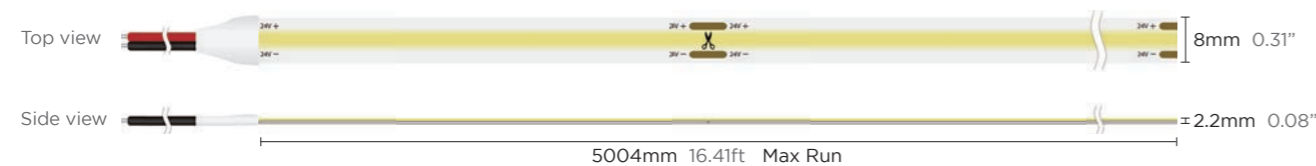

* Please contact our sales for the latest details and certifications



COB Essential/Weldless

480LEDS/M 12W 24V



Product NO. AU480012WW-24VCLM-COB

Technical Details

| Power | 12W/M 3.66W/ft | Lumens | | ErP Class | |
|-------------------------|----------------------|---------|-------------------|-----------|----------|
| Voltage | DC24V | ● 2700K | 1044lm/m 318lm/ft | | G |
| CRI | 90 | ● 3000K | 1104lm/m 336lm/ft | | F |
| Led Qty | 480LEDs/M 146LEDs/ft | ● 4000K | 1212lm/m 369lm/ft | | F |
| Length/Reel | 5004mm 16.41ft | ● 6500K | 1212lm/m 369lm/ft | | F |
| Cutting Length | 50mm 1.96" | | | | |
| Waterproof grade | IP20 / IP65 / IP68 | | | | |

Note:'x' (CCT) = "27"(2700K) / "30"(3000K) / "40"(4000K) / "50"(5000K) / "60"(6000K), Please contact us for more information.

Dimension

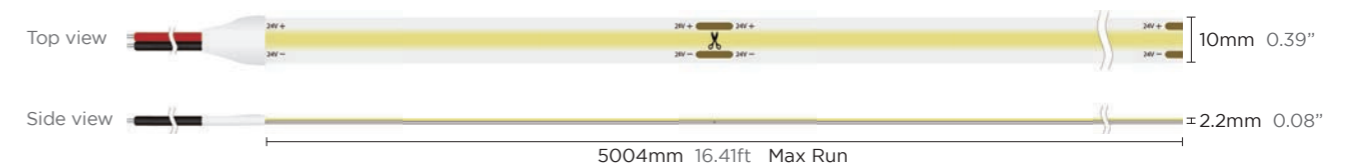

* Please contact our sales for the latest details and certifications



COB Essential/Mini cut 300LEDS/M 10W 12V



Product NO. AU300010WW-12VCLM-COB

Technical Details

| Power | 10W/M 3.04W/ft | Lumens | | |
|------------------|---------------------|---------|---------|----------|
| Voltage | DC12V | ● 2700K | 650lm/m | 198lm/ft |
| CRI | 90 | ● 3000K | 720lm/m | 219lm/ft |
| Led Qty | 300LEDS/M 91LEDS/ft | ● 4000K | 850lm/m | 259lm/ft |
| Length/Reel | 2500mm 8.36ft | ● 6500K | 800lm/m | 259lm/ft |
| Cutting Length | 10mm 0.39" | | | |
| Waterproof grade | IP20 | | | |

Note:'x' (CCT) = "27"(2700K) / "30"(3000K) / "40"(4000K) / "50"(5000K) / "60"(6000K), Please contact us for more information.

Dimension

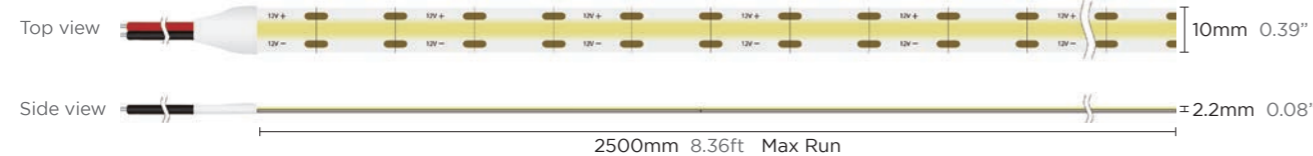

* Please contact our sales for the latest details and certifications



COB Essential/Mini cut 600LEDS/M 10W 24V



Product NO. AU600010WW-24VCLM-COB

Technical Details

| Power | 10W/M 3.04W/ft | Lumens | | |
|------------------|----------------------|---------|---------|----------|
| Voltage | DC24V | ● 2700K | 680lm/m | 207lm/ft |
| CRI | 90 | ● 3000K | 750lm/m | 228lm/ft |
| Led Qty | 600LEDS/M 183LEDS/ft | ● 4000K | 900lm/m | 274lm/ft |
| Length/Reel | 5004mm 16.41ft | ● 6500K | 820lm/m | 250lm/ft |
| Cutting Length | 10mm 0.39" | | | |
| Waterproof grade | IP20 | | | |

Note:'x' (CCT) = "27"(2700K) / "30"(3000K) / "40"(4000K) / "50"(5000K) / "60"(6000K), Please contact us for more information.

Dimension

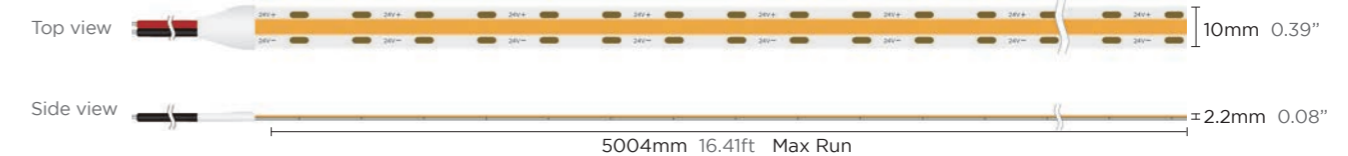

* Please contact our sales for the latest details and certifications

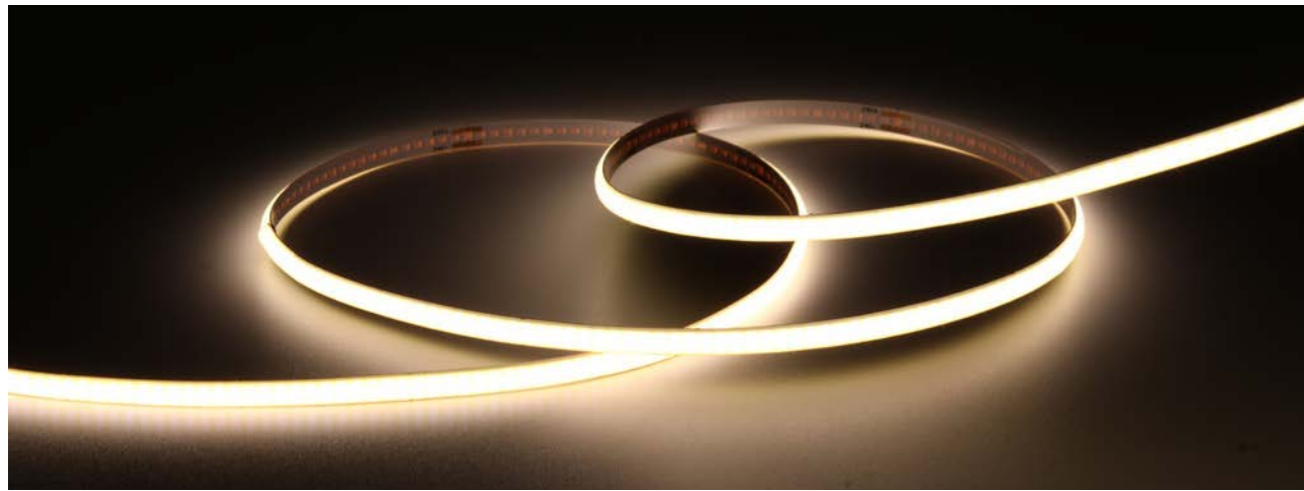

COB Essential/Mini PCB 4MM

480LEDS/M 4W 24V



Product NO. AU480004WW-24VCLM-COB

Technical Details

| Power | 4W/M 1.21W/ft | Lumens | | |
|-------------------------|----------------------|---------|---------|----------|
| Voltage | DC24V | ● 2700K | 350lm/m | 106lm/ft |
| CRI | 90 | ● 3000K | 380lm/m | 115lm/ft |
| Led Qty | 480LEDs/M 146LEDs/ft | ● 4000K | 420lm/m | 128lm/ft |
| Length/Reel | 2500mm 8.36ft | ● 6500K | 400lm/m | 121lm/ft |
| Cutting Length | 50mm 1.97" | | | |
| Waterproof grade | IP20 | | | |

Note: 'x' (CCT) = "27"(2700K) / "30"(3000K) / "40"(4000K) / "50"(5000K) / "60"(6000K), Please contact us for more information.

Dimension

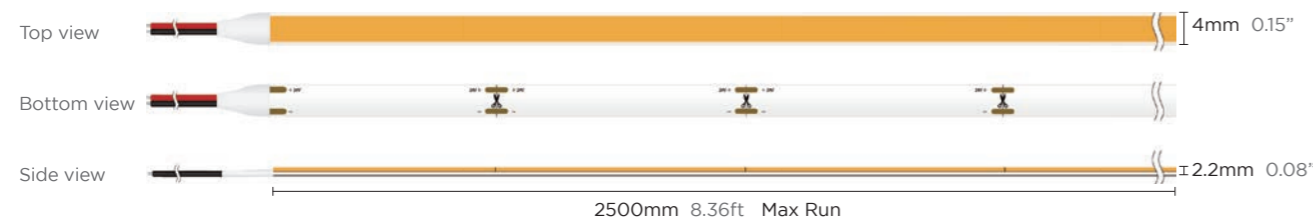

* Please contact our sales for the latest details and certifications

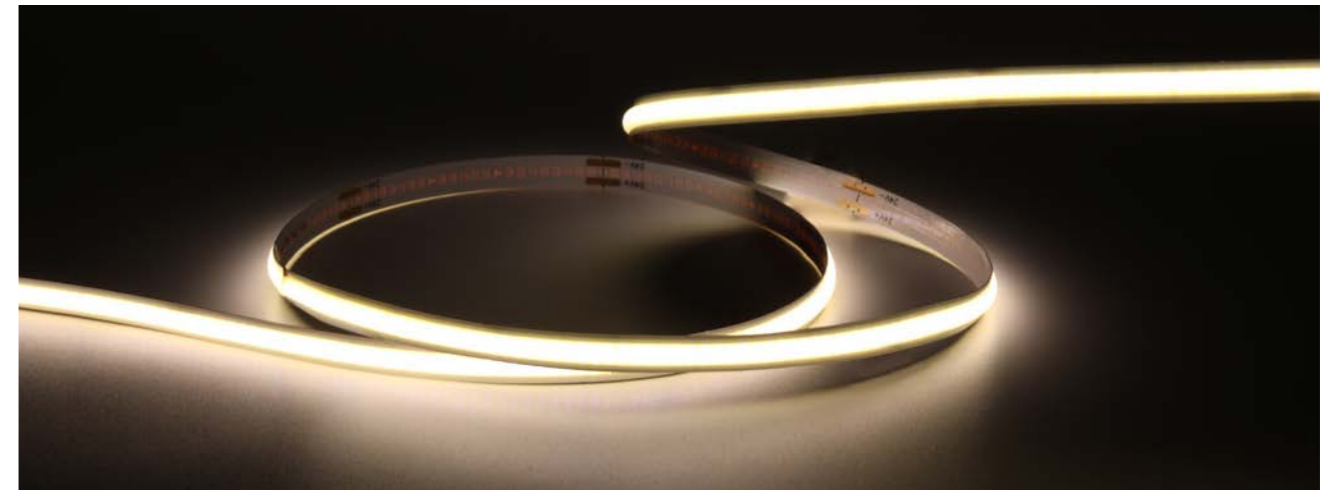

COB Essential/Mini PCB 6MM

480LEDS/M 6W 24V



Product NO. AU480006WW-24VCLM-COB

Technical Details

| Power | 6W/M 1.82W/ft | Lumens | | |
|-------------------------|----------------------|---------|---------|----------|
| Voltage | DC24V | ● 2700K | 480lm/m | 146lm/ft |
| CRI | 90 | ● 3000K | 580lm/m | 176lm/ft |
| Led Qty | 480LEDs/M 146LEDs/ft | ● 4000K | 630lm/m | 192lm/ft |
| Length/Reel | 5004mm 16.41ft | ● 6500K | 600lm/m | 182lm/ft |
| Cutting Length | 50mm 1.97" | | | |
| Waterproof grade | IP20 | | | |

Note: 'x' (CCT) = "27"(2700K) / "30"(3000K) / "40"(4000K) / "50"(5000K) / "60"(6000K), Please contact us for more information.

Dimension

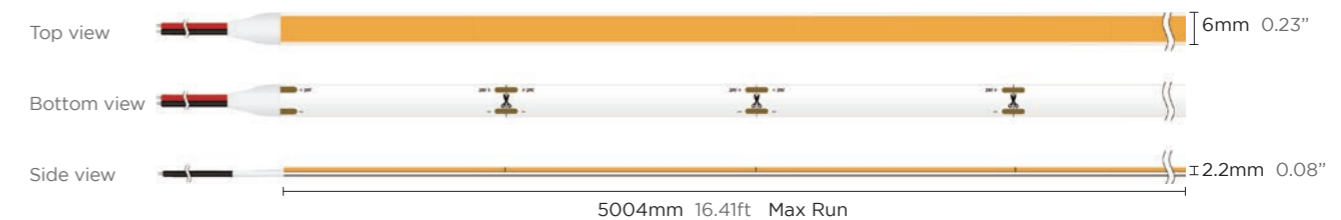

* Please contact our sales for the latest details and certifications

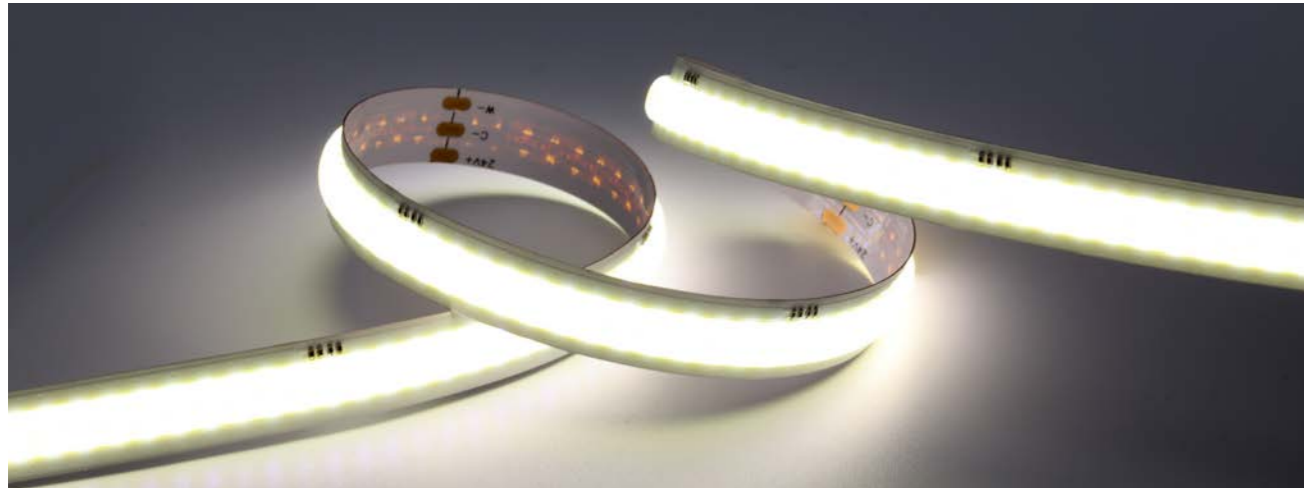

COB Essential/Tunable White

840LEDS/M 20W 24V



Product NO. AU840020WW-24VCLM-COB

Technical Details

| | | | | |
|-------------------------|----------------------|---------------|----------|----------|
| Power | 20W/M 6.09W/ft | Lumens | | |
| Voltage | DC24V | ● 2700K | 840lm/m | 256lm/ft |
| CRI | 90 | ● 6500K | 1840lm/m | 560lm/ft |
| Led Qty | 840LEDs/M 256LEDs/ft | | | |
| Length/Reel | 5004mm 16.41ft | | | |
| Cutting Length | 50mm 1.97" | | | |
| Waterproof grade | IP20 / IP65 / IP68 | | | |

Note:'x' (CCT) = "27"(2700K) / "30"(3000K) / "40"(4000K) / "50"(5000K) / "60"(6000K), Please contact us for more information.

Dimension

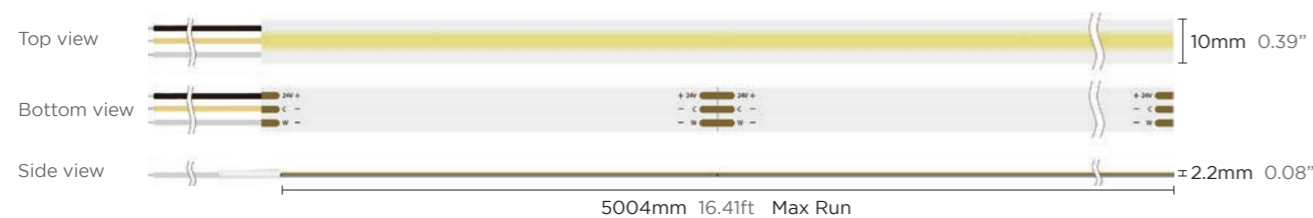

* Please contact our sales for the latest details and certifications

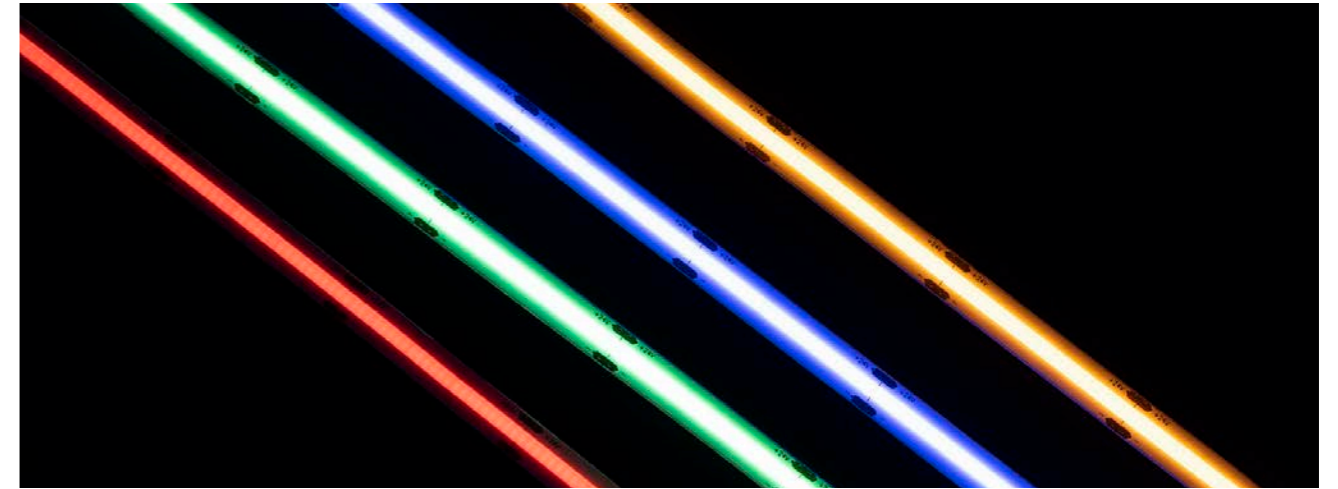

COB Essential/R/G/B/Y

480LEDS/M 10W 24V



Product NO. AU480010WR-24VCLM-COB

Technical Details

| | | | | |
|-------------------------|----------------------|---------------|----------|----------|
| Power | 10W/M 3.04W/ft | Lumens | | |
| Voltage | DC24V | ● R | 88lm/m | 26lm/ft |
| CRI | - | ● G | 1000lm/m | 304lm/ft |
| Led Qty | 480LEDs/M 146LEDs/ft | | | |
| Length/Reel | 5004mm 16.41ft | | | |
| Cutting Length | 50mm 1.97" | | | |
| Waterproof grade | IP20 / IP65 / IP68 | | | |

Note:'x' (CCT) = "27"(2700K) / "30"(3000K) / "40"(4000K) / "50"(5000K) / "60"(6000K), Please contact us for more information.

Dimension



* Please contact our sales for the latest details and certifications

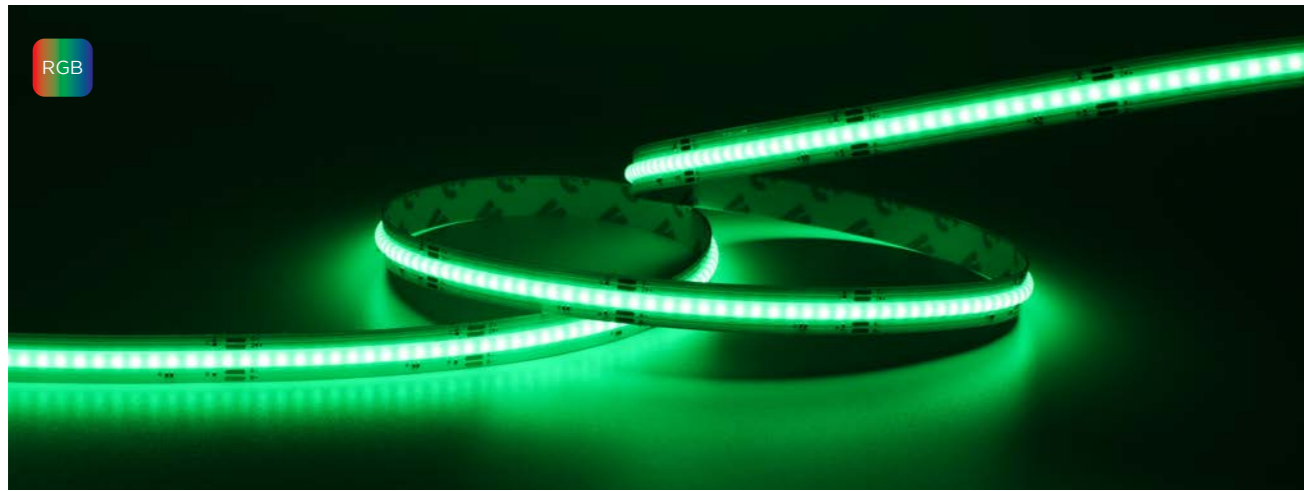

COB Essential/RGB



588LEDS/M 15W 24V

Product NO.
AU588015WR-24VCLM-COB

Technical Details

| | | |
|-------------------------|----------------------|----------------------|
| Power | 15W/M 4.57W/ft | 15W/M 4.26W/ft |
| Voltage | DC24V | DC24V |
| CRI | - | - |
| Led Qty | 588LEDS/M 179LEDS/ft | 840LEDS/M 256LEDS/ft |
| Length/Reel | 5004mm 16.41ft | 5004mm 16.41ft |
| Cutting Length | 35.7mm 1.4" | 25mm 0.98" |
| Waterproof grade | IP20 / IP65 / IP68 | IP20 / IP65 / IP68 |

Lumens

| | | | | | |
|----------|---------|----------|----------|---------|----------|
| R | 140lm/m | 42lm/ft | R | 140lm/m | 42lm/ft |
| G | 500lm/m | 152lm/ft | G | 360lm/m | 109lm/ft |
| B | 80lm/m | 24lm/ft | B | 70lm/m | 21lm/ft |

Dimension

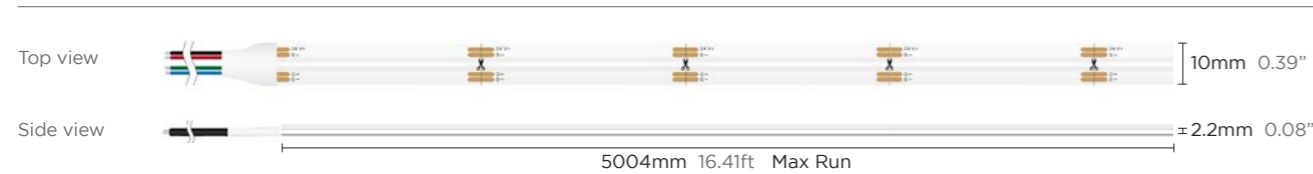

* Please contact our sales for the latest details and certifications



COB Essential/RGBW

840LEDS/M 18W 24V



Product NO.
AU840018WRW-24VCLM-COB

| | |
|-------------------------|----------------------|
| Power | 18W/M 5.48W/ft |
| Voltage | DC24V |
| CRI | - |
| Led Qty | 840LEDS/M 256LEDS/ft |
| Length/Reel | 5004mm 16.41ft |
| Cutting Length | 33.3mm 1.31" |
| Waterproof grade | IP20 / IP65 / IP68 |

| Lumens | | Peak WL |
|----------|------------------|--------------|
| R | 80lm/m 24lm/ft | Lp=620-630nm |
| G | 287lm/m 87lm/ft | Lp=520-530nm |
| B | 85lm/m 25lm/ft | Lp=460-470nm |
| W | 365lm/m 111lm/ft | CCT=3000K |

Note: 'x' (CCT) = *27*(2700K) / *30*(3000K) / *40*(4000K) / *50*(5000K) / *60*(6000K), Please contact us for more information.

Dimension

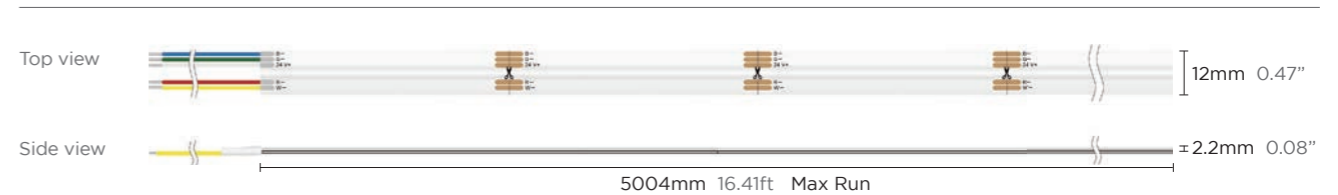

* Please contact our sales for the latest details and certifications

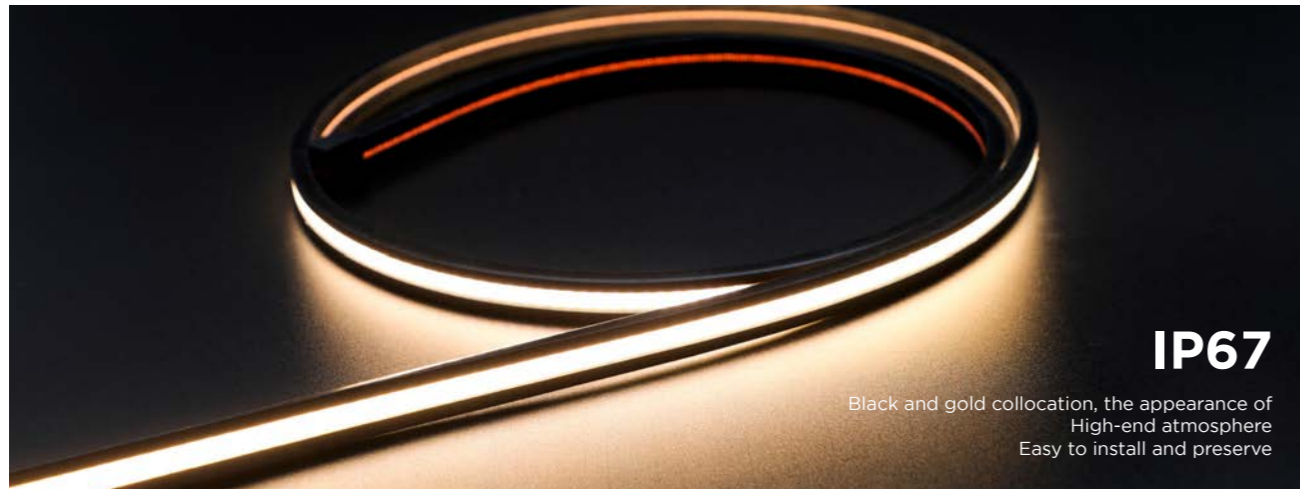

IP67

Black and gold collocation, the appearance of High-end atmosphere
Easy to install and preserve

COB NEON/Black Gold

320LEDS/M 8W 24V



Product NO. AU320008WW-24VCLM-COB-BG

Technical Details

| Power | 8W/M 2.43W/ft | Lumens | | |
|-------------------------|---------------------|---------|---------|----------|
| Voltage | DC24V | ● 2700K | 480lm/m | 146lm/ft |
| CRI | 90 | ● 3000K | 520lm/m | 158lm/ft |
| Led Qty | 320LEDS/M 97LEDS/ft | ● 4000K | 650lm/m | 198lm/ft |
| Length/Reel | 5050mm 16.56ft | ● 6500K | 650lm/m | 198lm/ft |
| Cutting Length | 50mm 1.97" | | | |
| Waterproof grade | IP67 | | | |

Note: 'x' (CCT) = *27*(2700K) / *30*(3000K) / *40*(4000K) / *50*(5000K) / *60*(6000K), Please contact us for more information.

Dimension

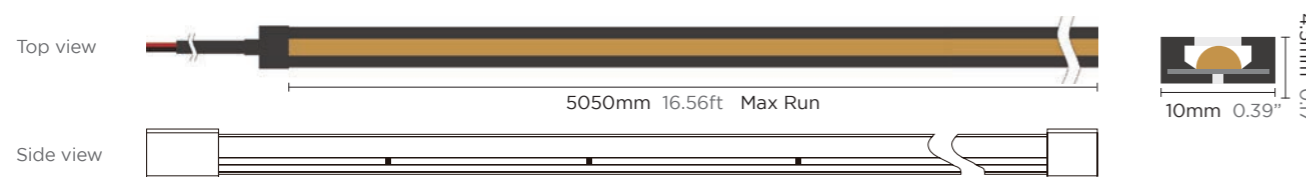

Accessories



* Please contact our sales for the latest details and certifications

COB SERIES · BLACK GOLD



IP67

White and gold collocation, the appearance of High-end atmosphere
Easy to install and preserve

COB NEON/White Gold

320LEDS/M 8W 24V



Product NO. AU320008WW-24VCLM-COB-WG

Technical Details

| Power | 8W/M 2.43W/ft | Lumens | | |
|-------------------------|---------------------|---------|---------|----------|
| Voltage | DC24V | ● 2700K | 480lm/m | 146lm/ft |
| CRI | 90 | ● 3000K | 520lm/m | 158lm/ft |
| Led Qty | 320LEDS/M 97LEDS/ft | ● 4000K | 650lm/m | 198lm/ft |
| Length/Reel | 5050mm 16.56ft | ● 6500K | 650lm/m | 198lm/ft |
| Cutting Length | 50mm 1.97" | | | |
| Waterproof grade | IP67 | | | |

Note: 'x' (CCT) = *27*(2700K) / *30*(3000K) / *40*(4000K) / *50*(5000K) / *60*(6000K), Please contact us for more information.

Dimension

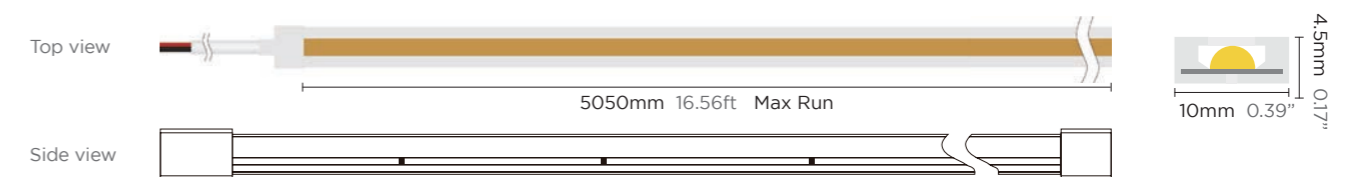

Accessories

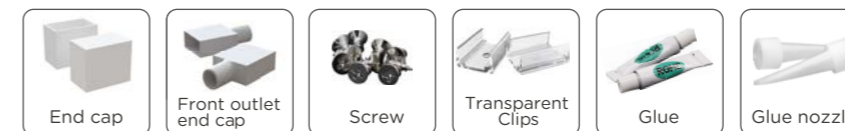

* Please contact our sales for the latest details and certifications

COB SERIES · WHITE GOLD

COB Connectors

Single Color

| Series | Product | | | PCB Width | Product NO. |
|---|---------------|-----------------|-------------------------|-----------|--|
| | BB PCB to PCB | XB Cable to PCB | BXB PCB to Cable to PCB | | |
| LD- COB H Series Maximum voltage: 36V Maximum current: 5A | | | | 8mm | ACOB2P-C08BB-UG1 ACOB2P-C08XB-UG1 ACOB2P-C08MBXB-UG1 |
| | | | | 10mm | ACOB2P-C10BB-UG1 ACOB2P-C10XB-UG1 ACOB2P-C10MBXB-UG1 |
| LD- COB E Series Maximum voltage: 36V Maximum current: 5A | | | | 8mm | ACOB2P-C08BB-UG1 ACOB2P-C08XB-UG1 ACOB2P-C08MBXB-UG1 |
| | | | | 10mm | ACOB2P-C10BB-UG1 ACOB2P-C10XB-UG1 ACOB2P-C10MBXB-UG1 |

Tunable

| Series | Product | | | PCB Width | Product NO. |
|---|---------------|-----------------|-------------------------|-----------|--|
| | BB PCB to PCB | XB Cable to PCB | BXB PCB to Cable to PCB | | |
| LD- COB H Series Maximum voltage: 36V Maximum current: 5A | | | | 8mm | ACOB3/4P-C10BB-UG1 ACOB3P-C10XB-UG1 ACOB3P-C10MBXB-UG1 |
| | | | | 10mm | ACOB2P-C10BB-UG1 ACOB2P-C10XB-UG1 ACOB2P-C10MBXB-UG1 |

RGB

| Series | Product | | | PCB Width | Product NO. |
|---|---------------|-----------------|-------------------------|-----------|--|
| | BB PCB to PCB | XB Cable to PCB | BXB PCB to Cable to PCB | | |
| LD- COB H Series Maximum voltage: 36V Maximum current: 5A | | | | 10mm | ACOB3/4P-C10BB-UG1 ACOB4P-C10XB-UG1 ACOB4P-C10MBXB-UG1 |
| LD- COB E Series Maximum voltage: 36V Maximum current: 5A | | | / | 10mm | ACOB4P-UC10BB ASMD4P-UC10BB ACOB4P-UC10XB |

COB IP Rating

| | |
|---|--|
| <p>IP20 Ribbon Series</p> | |
| <p>IP65 Hollow Extrusion</p> | |
| <p>NEON IP67</p> | |
| <p>IP68 Jade series</p> | |

FLEXIBLE WALL WASHER SERIES

Module Wall washer

3D Wall washer

Rainbow Wall washer

Spotless wall washer

Mini wall washer



Module Wall washer

30x21mm

White / 36W / 24V



1 Module 1 Cutting,
Washing height up to 7m.
UV resistant PC lens, IP67 for outdoor application.
Designed for unconventional space,
not just appearance, more creativity and feasibility.

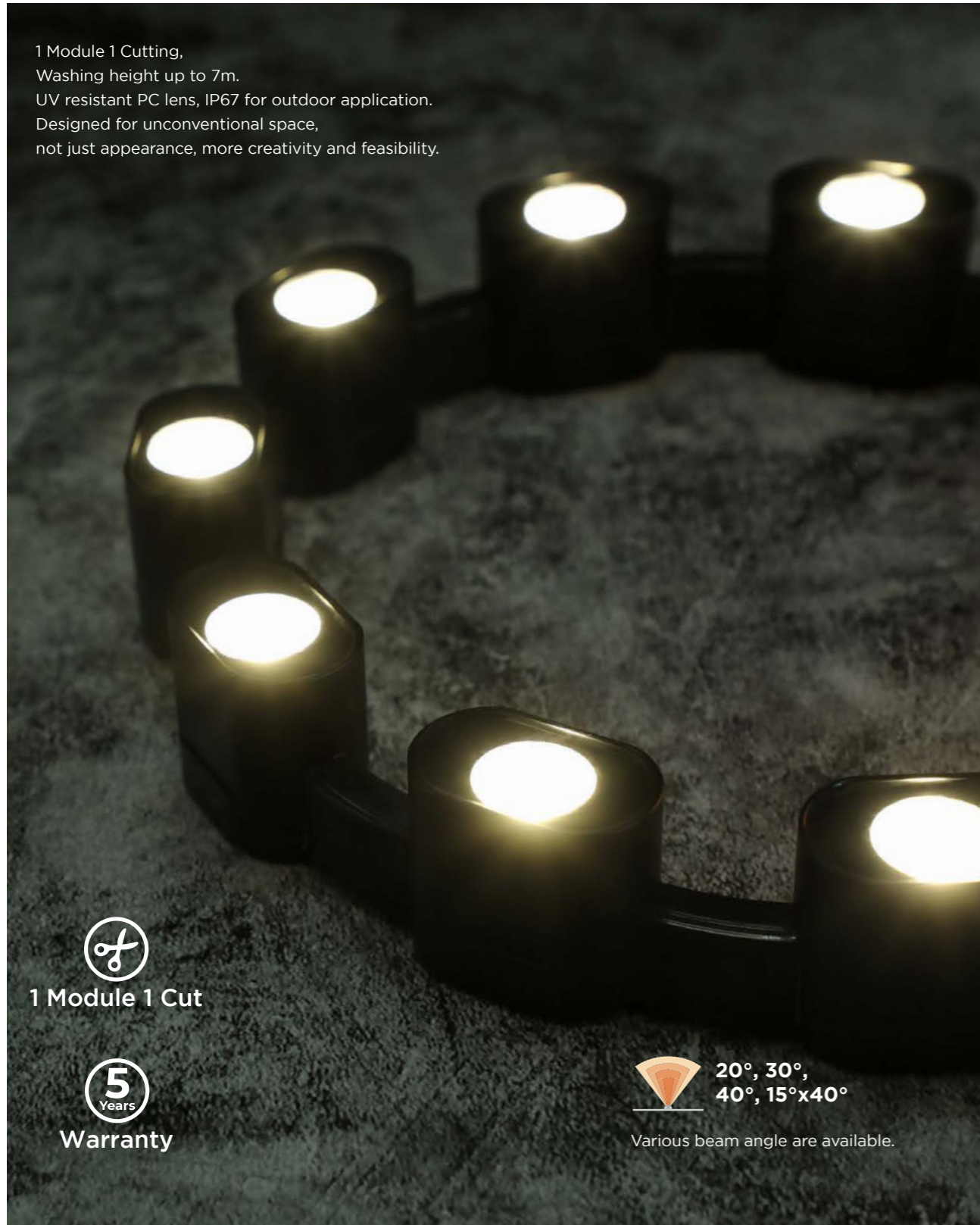

FLEXIBLE WALL WASHER · MODULE WALL WASHER

 1 Module 1 Cut

 5 Years Warranty

 20°, 30°, 40°, 15°x40°
Various beam angle are available.



FLEXIBLE WALL WASHER · MODULE WALL WASHER

| Technical Details | Product NO. AU302136WB-24VCLM-WALL | | | |
|-------------------------|------------------------------------|----------------------|----------------------|----------------------|
| Voltage | DC24V | | | |
| Power | 36W/M 10.97W/ft | | | |
| CRI | 80 (3030LEDs) | | | |
| Led Qty | 20LEDs/M 6LEDs/ft | | | |
| Cutting Length | 300mm 11.8" | | | |
| Waterproof grade | IP67 | | | |
| Length/Reel | 2.4m 7.87ft | | | |
| Lumens | 20° | 30° | 40° | 15x40° |
| ● 2700K | 2235lm/m 681lm/ft | 2270lm/m 692lm/ft | 2055lm/m 627lm/ft | 1945lm/m 593lm/ft |
| ● 3000K | 2630lm/m 802lm/ft | 2670lm/m 814lm/ft | 2420lm/m 738lm/ft | 2280lm/m 695lm/ft |
| ● 4000K | 3060lm/m 933lm/ft | 3140lm/m 957lm/ft | 2850lm/m 869lm/ft | 2520lm/m 768lm/ft |
| ○ 5000K | 3060lm/m 933lm/ft | 3140lm/m 957lm/ft | 2850lm/m 869lm/ft | 2520lm/m 768lm/ft |

Note: 'x' (CCT) = *27*(2700K) / *30*(3000K) / *40*(4000K) / *50*(5000K) / *60*(6000K), Please contact us for more information.

Dimension

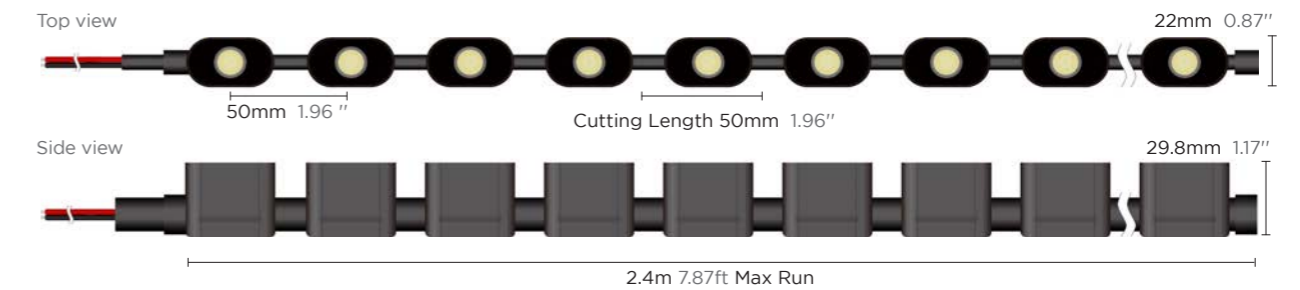

* Please contact our sales for the latest details and certifications

Module Wall washer

30x20mm

White / RGBW / 36W / 24V

Break through space limitations.
Designed for unconventional space
Not just appearance, more creativity and feasibility



Correct bending way Side bending

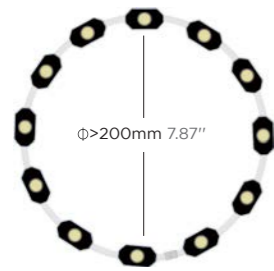

White / Side bending

Product NO. AU302036WW-24VCLM-WALL

RGBW Side bending

Product NO. AU302036WR-24VCLM-WALL

Technical Details

| White / Side bending | | | | | | RGBW Side bending | | | | |
|------------------------------------|----------------------|----------------------|----------------------|----------------------|----------------------|------------------------------------|---------------------|---------------------|---------------------|---------------------|
| Product NO. AU302036WW-24VCLM-WALL | | | | | | Product NO. AU302036WR-24VCLM-WALL | | | | |
| Voltage | DC24V | | | | | DC24V | | | | |
| Power | 36W/M 10.97W/ft | | | | | 36W/M 10.97W/ft | | | | |
| CRI | 80 (3030LEDs) | | | | | 80 (3535LEDs) | | | | |
| Led Qty | 20LEDs/M 6LEDs/ft | | | | | 20LEDs/M 6LEDs/ft | | | | |
| Cutting Length | 300mm 11.8" | | | | | 300mm 11.8" | | | | |
| Waterproof grade | IP67 | | | | | IP67 | | | | |
| Length/Reel | 1.2m/2.4m | 3.93ft/7.87ft | | | | 1.2m/2.4m | 3.93ft/7.87ft | | | |
| Lumens | 20° | 30° | 45° | 60° | 20x45° | 20° | 30° | 45° | 60° | 20x45° |
| ● 2700K | 2469lm/m 752lm/ft | 2418lm/m 737lm/ft | 2160lm/m 658lm/ft | 2109lm/m 642lm/ft | 2160lm/m 658lm/ft | ● R 237lm/m 72lm/ft | 231lm/m 70lm/ft | 207lm/m 63lm/ft | 203lm/m 61lm/ft | 207lm/m 63lm/ft |
| ● 3000K | 2469lm/m 752lm/ft | 2418lm/m 737lm/ft | 2160lm/m 658lm/ft | 2109lm/m 642lm/ft | 2160lm/m 658lm/ft | ● G 591lm/m 180lm/ft | 579lm/m 176lm/ft | 518lm/m 157lm/ft | 506lm/m 154lm/ft | 518lm/m 157lm/ft |
| ● 4000K | 2666lm/m 812lm/ft | 2610lm/m 795lm/ft | 2333lm/m 711lm/ft | 2277lm/m 694lm/ft | 2333lm/m 711lm/ft | ● B 96lm/m 29lm/ft | 95lm/m 28lm/ft | 84lm/m 25lm/ft | 83lm/m 25lm/ft | 84lm/m 25lm/ft |
| ○ 5000K | 2863lm/m 872lm/ft | 2804lm/m 854lm/ft | 2506lm/m 764lm/ft | 2446lm/m 745lm/ft | 2506lm/m 764lm/ft | ○ White 464lm/m 141lm/ft | 483lm/m 147lm/ft | 432lm/m 131lm/ft | 422lm/m 128lm/ft | 432lm/m 131lm/ft |

Note: 'x' (CCT) = *27*(2700K) / *30*(3000K) / *40*(4000K) / *50*(5000K) / *60*(6000K), Please contact us for more information.

Dimension

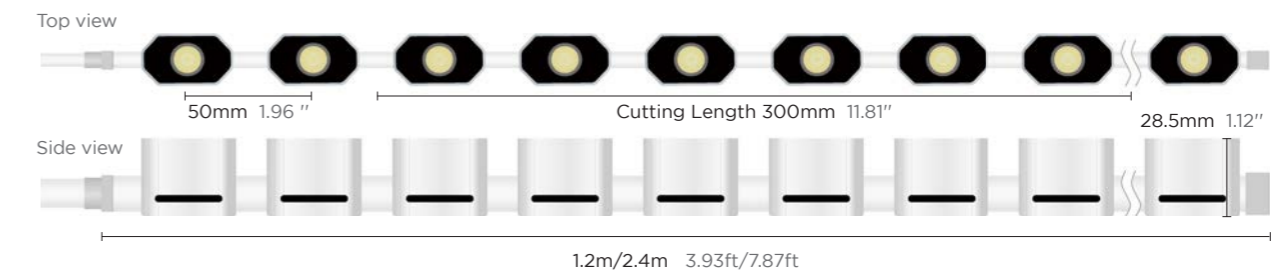

* Please contact our sales for the latest details and certifications

3D Wall washer

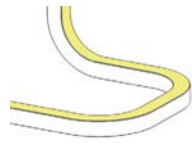

27x16mm
CCT / 24W / 24V

Easy installation.
Min top bending radius 300mm, min side bending radius 800mm.
Beam angles of 20°, 30°, 45°, 60°, 20°x 45° are available.



Correct bending way

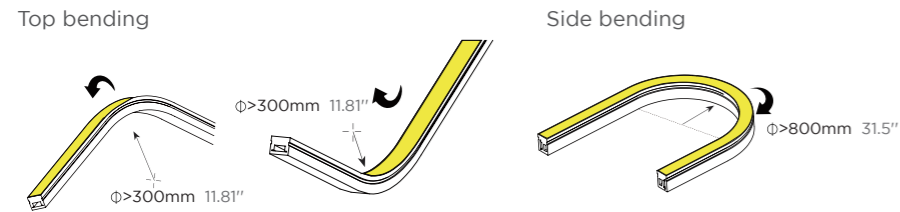

CCT 3D Bending

Product NO.
AU271624WW-24VCLM-WALL3D

Technical Details

| | | | | | | | |
|-------------------------|-------------------|-------------------|-------------------|-------------------|-------------------|--|--|
| Voltage | DC24V | | | | | | |
| Power | 24W/M 7.31W/ft | | | | | | |
| CRI | 90 (3030LEDs) | | | | | | |
| Led Qty | 24LEDs/M 7LEDs/ft | | | | | | |
| Cutting Length | 41.67mm 1.64" | | | | | | |
| Waterproof grade | IP67 | | | | | | |
| Length/Reel | 5020mm 16.46ft | | | | | | |
| Lumens | 20° | 30° | 45° | 60° | 20x45° | | |
| ● 2700K | 1965lm/m 599lm/ft | 1925lm/m 587lm/ft | 1750lm/m 533lm/ft | 1750lm/m 533lm/ft | 1785lm/m 544lm/ft | | |
| ● 3000K | 1965lm/m 599lm/ft | 1925lm/m 586lm/ft | 1750lm/m 533lm/ft | 1750lm/m 533lm/ft | 1785lm/m 544lm/ft | | |
| ● 4000K | 2120lm/m 646lm/ft | 2080lm/m 634lm/ft | 1890lm/m 576lm/ft | 1890lm/m 576lm/ft | 1930lm/m 588lm/ft | | |
| ● 5000K | 2245lm/m 684lm/ft | 2200lm/m 670lm/ft | 2000lm/m 670lm/ft | 2000lm/m 670lm/ft | 2040lm/m 621lm/ft | | |

Note: 'x' (CCT) = "27"(2700K) / "30"(3000K) / "40"(4000K) / "50"(5000K) / "60"(6000K), Please contact us for more information.

Dimension

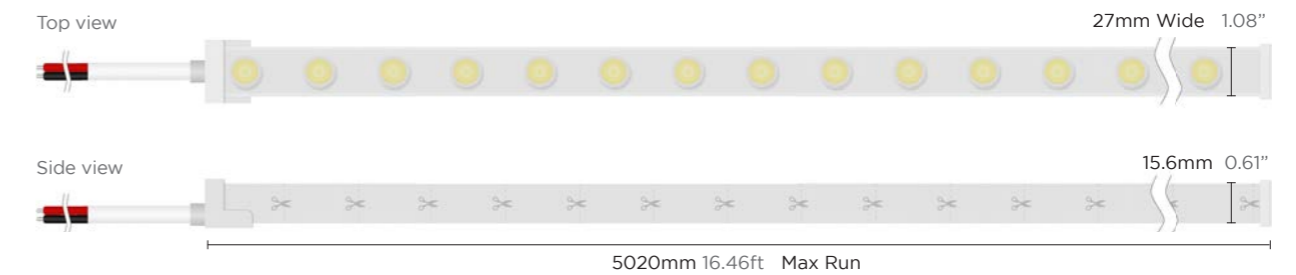

* Please contact our sales for the latest details and certifications

Rainbow Wall washer



27x16mm RGB Top Bending / RGBW Top Bending 24W / 24V

Min top bending radius 15 cm, min side bending radius 40cm.
Beam angles of 20°, 30°, 45°, 60°, 20°x 45° are available.



Correct bending way

Top bending

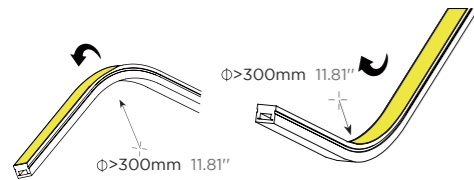

RGB Top bending

| | |
|-------------------------|--|
| Technical Details | Product NO. AU271624WR-24VCLM-WALL-RAINBOW |
| Voltage | DC24V |
| Power | 24W/M 7.31W/ft |
| CRI | - (3030LEDs) |
| Led Qty | 24LEDs/M 7LEDs/ft |
| Cutting Length | 250mm 9.84" |
| Waterproof grade | IP67 |
| Length/Reel | 5020mm 16.46ft |

| Lumens | 20° | 30° | 45° | 60° | 20x45° |
|--------------|---------------------|---------------------|---------------------|---------------------|---------------------|
| R ● Lp=625nm | 262lm/m 79lm/ft | 230lm/m 70lm/ft | 205lm/m 79lm/ft | 205lm/m 79lm/ft | 210lm/m 64lm/ft |
| G ● Lp=525nm | 556lm/m 169lm/ft | 486lm/m 148lm/ft | 435lm/m 132lm/ft | 435lm/m 132lm/ft | 445lm/m 135lm/ft |
| B ● Lp=465nm | 120lm/m 36lm/ft | 105lm/m 32lm/ft | 94lm/m 28lm/ft | 94lm/m 28lm/ft | 96lm/m 29lm/ft |



RGBW Top bending

| | |
|-------------------------|---|
| Technical Details | Product NO. AU271624WRW-24VCLM-WALL-RAINBOW |
| Voltage | DC24V |
| Power | 24W/M 7.31W/ft |
| CRI | 80 (3535LEDs) |
| Led Qty | 24LEDs/M 7LEDs/ft |
| Cutting Length | 250mm 9.84" |
| Waterproof grade | IP67 |
| Length/Reel | 5020mm 16.46ft |

| Lumens | 20° | 30° | 45° | 60° | 20x45° |
|---------|---------------------|-------------------|-------------------|-------------------|-------------------|
| ● R | 225lm/m 68lm/ft | 220lm 67lm/ft | 200lm 60lm/ft | 200lm 60lm/ft | 205lm 79lm/ft |
| ● G | 570lm/m 173lm/ft | 560lm 170lm/ft | 510lm 155lm/ft | 510lm 155lm/ft | 520lm 158lm/ft |
| ● B | 185lm/m 56lm/ft | 180lm 54lm/ft | 165lm 50lm/ft | 165lm 50lm/ft | 170lm 51lm/ft |
| ○ White | 480lm/m 146lm/ft | 470lm 143lm/ft | 425lm 129lm/ft | 425lm 129lm/ft | 430lm 131lm/ft |
| ● 3000K | | | | | |

Note: 'x' (CCT) = "27"(2700K) / "30"(3000K) / "40"(4000K) / "50"(5000K) / "60"(6000K), Please contact us for more information.

Dimension

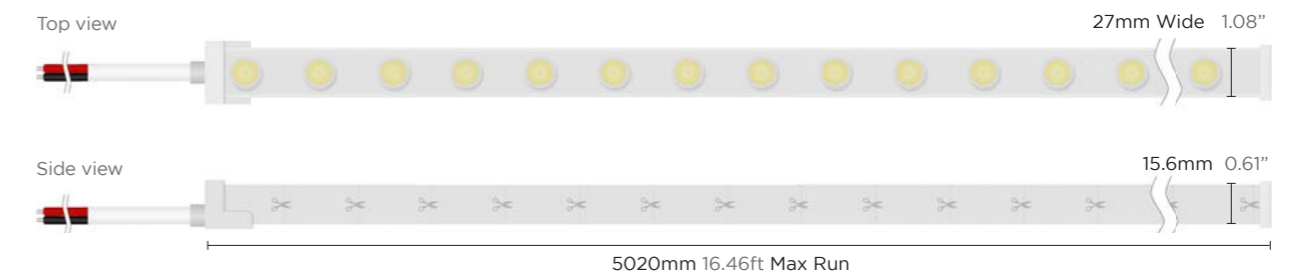

* Please contact our sales for the latest details and certifications

Spotless wall washer

24x21mm / 30°*100°
White / RGB / RGBW

Top bending and top emitting product.
 Uniform illumination, better cost-effectiveness.
 IP65 and salt-mist proof, L70B50 > 50,000hrs Min.
 Bending radius 15 cm, beam angles 30°*100°.



Correct bending way

Top bending

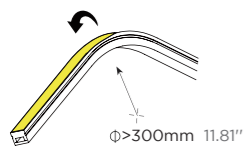

| | White | RGB | RGBW |
|--------------------------|--|--|---|
| | Product NO. AU242120WW-24VCLM-SWALL | Product NO. AU242120WR-24VCLM-SWALL | Product NO. AU242120WRW-24VCLM-SWALL |
| Technical Details | | | |
| Voltage | DC24V | DC24V | DC24V |
| Power | 20W/M 6.09W/ft | 20W/M 6.09W/ft | 20W/M 6.09W/ft |
| CRI | 90 (2835LEDs) | - (5050LEDs) | 80 (5050RGB+2835LEDs) |
| Led Qty | 70LEDs/M 21LEDs/ft | 70LEDs/M 21LEDs/ft | 70LEDs/M 21LEDs/ft |
| Cutting Length | 100mm 3.93" | 100mm 3.93" | 100mm 3.93" |
| Waterproof grade | IP65 | IP65 | IP65 |
| Length/Reel | 5020mm 16.46ft | 5020mm 16.46ft | 5020mm 16.46ft |
| Lumens | 30x100° | Peak WL 30x100° | Peak WL 30x100° |
| | ● 2700K 1700lm/m 518lm/ft | ● R Lp=640-630nm 175lm/m 53lm/ft | ● R Lp=640-630nm 130lm/m 39lm/ft |
| | ● 3000K 1800lm/m 548lm/ft | ● G Lp=520-530nm 455lm/m 138lm/ft | ● G Lp=520-530nm 300lm/m 91lm/ft |
| | ● 4000K 1900lm/m 579lm/ft | ● B Lp=460-470nm 115lm/m 35lm/ft | ● B Lp=460-470nm 85lm/m 25lm/ft |
| | ○ 5000K 1900lm/m 579lm/ft | | ○ White ● 3000K 400lm/m 121lm/ft |

Note: 'x' (CCT) = *27*(2700K) / *30*(3000K) / *40*(4000K) / *50*(5000K) / *60*(6000K), Please contact us for more information.

Dimension

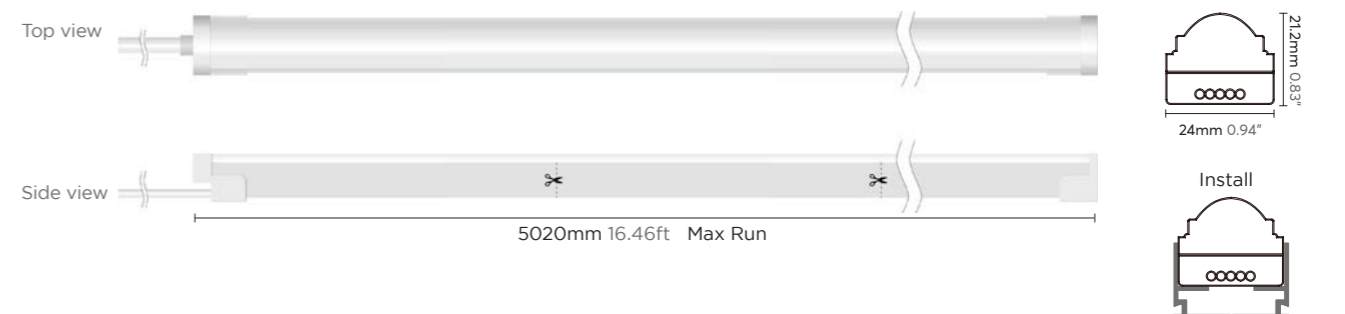

* Please contact our sales for the latest details and certifications

Spotless wall washer

24x20mm / 60*100°
White

Top bending and top emitting product.
Uniform illumination, better cost-effectiveness.
IP65 and salt-mist proof, L70B50 > 50,000hrs Min.



Correct bending way

Top bending

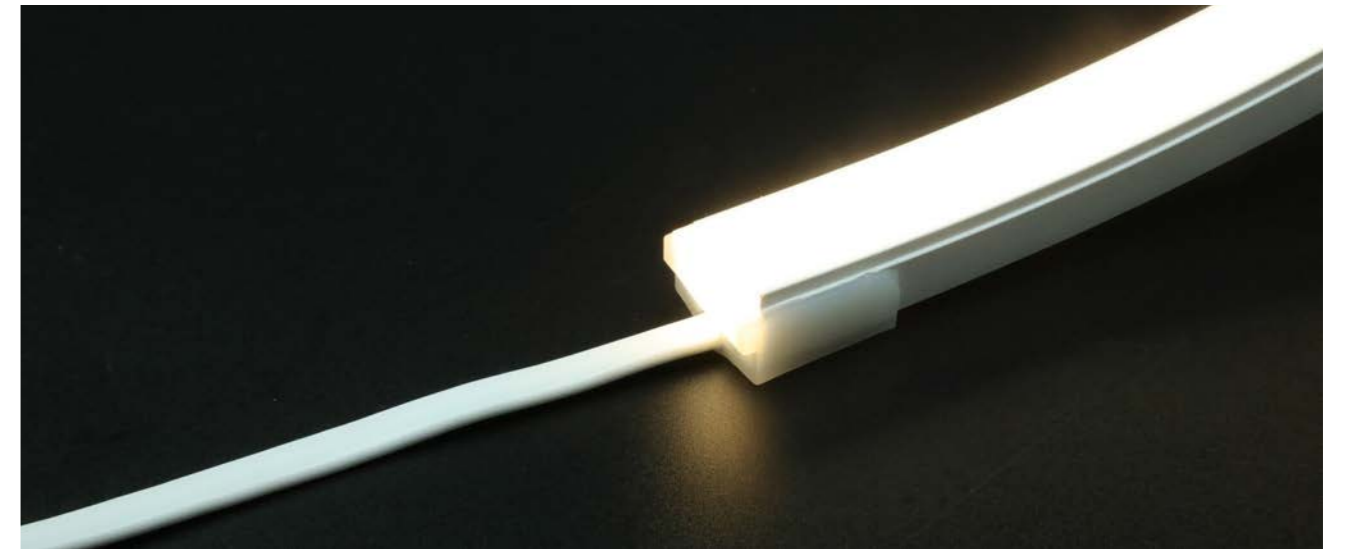
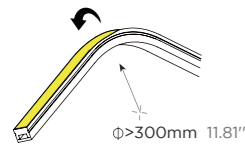

2700K 3000K 4000K 6000K

24x20mm 19W

Technical Details **Product NO.** AU242019WW-24VCLM-SWALL

| | | |
|-------------------------|--------------------|-------------------|
| Voltage | DC24V | |
| Power | 19.2W/M 5.85W/ft | |
| CRI | 90 (2835LEDs) | |
| Led Qty | 60LEDs/M 18LEDs/ft | |
| Cutting Length | 100mm 3.93" | |
| Waterproof grade | IP65 | |
| Length/Reel | 5020mm 16.46ft | |
| Lumens | 60x100° | |
| | ● 2700K | 1535lm/m 468lm/ft |
| | ● 3000K | 1575lm/m 480lm/ft |
| | ● 4000K | 1700lm/m 518lm/ft |
| | ○ 6000K | 1700lm/m 518lm/ft |

Note: 'x' (CCT) = *27*(2700K) / *30*(3000K) / *40*(4000K) / *50*(5000K) / *60*(6000K), Please contact us for more information.

Dimension

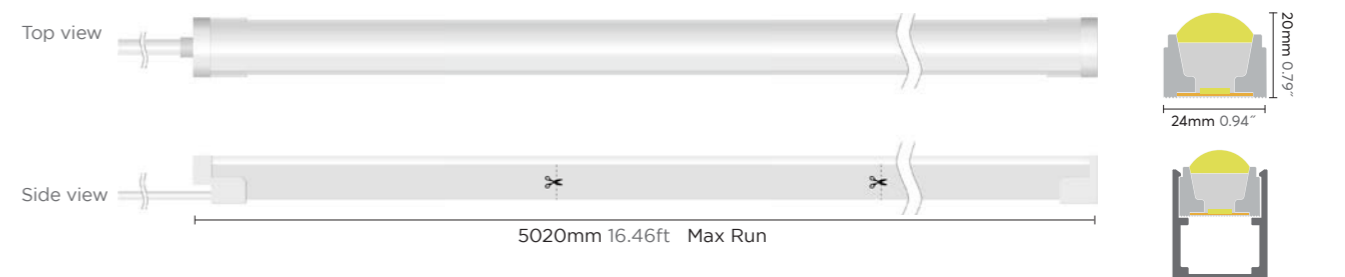

* Please contact our sales for the latest details and certifications



12x8mm Mini wall washer

2835 SMD/5050 SMD



56LEDs/M 14W 30°

Product NO. AU120814WW-24VCLM-MWALL30

Technical Details

| | |
|-------------------------|--|
| Power | 14.4W/M 4.39W/ft |
| Voltage | DC24V |
| CRI | 90 (2835LEDs) |
| Led Qty | 56LEDs/M 17LEDs/ft |
| Length/Reel | 5020mm 16.46ft |
| Cutting Length | 125mm 4.92" / 6LEDs Group |
| Waterproof grade | IP67 |
| Lumens | <ul style="list-style-type: none"> ● 2700K 1190lm/m 362lm/ft ● 3000K 1260lm/m 387lm/ft ● 4000K 1344lm/m 409lm/ft ● 5000K 1288lm/m 392lm/ft |

60LEDs/M 14W 60°

Product NO. AU120814WW-24VCLM-MWALL60

| | |
|-------------------------|--|
| Power | 14.4W/M 4.39W/ft |
| Voltage | DC24V |
| CRI | 90 (5050LEDs) |
| Led Qty | 60LEDs/M 18LEDs/ft |
| Length/Reel | 5020mm 16.46ft |
| Cutting Length | 100mm 3.93" / 7LEDs Group |
| Waterproof grade | IP67 |
| Lumens | <ul style="list-style-type: none"> ● 2700K 838lm/m 255lm/ft ● 3000K 856lm/m 260lm/ft ● 4000K 920lm/m 280lm/ft ● 5000K 875lm/m 266lm/ft |

Note: 'x' (CCT) = *27*(2700K) / *30*(3000K) / *40*(4000K) / *50*(5000K) / *60*(6000K), Please contact us for more information.

Dimension



Accessories



* Please contact our sales for the latest details and certifications

FLEXIBLE WALL WASHER · MINI WALL WASHER



20x10mm Mini wall washer

3030 SMD



24LEDs/M 18W 24V 15°, 30°, 45°, 60°, 25x45°, 25x45x10°

Product NO. AU201018WW-24VCLM-MWALL-D

Technical Details

| Power | Voltage | CRI | Led Qty | Length/Reel | Cutting Length | Waterproof grade |
|-------------------|----------------------|----------------------|----------------------|----------------------|---|----------------------|
| 18W/M 5.49W/ft | DC24V | 80 | 24LEDs/M 7LEDs/ft | 5020mm 16.46ft | 125mm/ 3LEDs Group 4.92" / 3LEDs Group | IP67 |
| Lumens | 15° | 30° | 45° | 60° | 25x45° | 25x45x10° |
| ● 2700K | 1680lm/m 512lm/ft | 1660lm/m 506lm/ft | 1640lm/m 500lm/ft | 1620lm/m 493lm/ft | 1580lm/m 481lm/ft | 1560lm/m 475lm/ft |
| ● 3000K | 1780lm/m 542lm/ft | 1760lm/m 536lm/ft | 1740lm/m 530lm/ft | 1720lm/m 524lm/ft | 1740lm/m 530lm/ft | 1720lm/m 524lm/ft |
| ● 4000K | 1800lm/m 548lm/ft | 1800lm/m 548lm/ft | 1780lm/m 542lm/ft | 1760lm/m 536lm/ft | 1780lm/m 542lm/ft | 1760lm/m 536lm/ft |
| ● 5000K | 1840lm/m 560lm/ft | 1840lm/m 560lm/ft | 1820lm/m 554lm/ft | 1800lm/m 548lm/ft | 1820lm/m 554lm/ft | 1800lm/m 548lm/ft |

Note: 'x' (CCT) = *27*(2700K) / *30*(3000K) / *40*(4000K) / *50*(5000K) / *60*(6000K), Please contact us for more information.

Dimension



Accessories



* Please contact our sales for the latest details and certifications

FLEXIBLE WALL WASHER · MINI WALL WASHER



20x10mm Mini wall washer

5050 SMD/RGB/RGBW



RGB 28LEDS/M 19W 24V
30°, 60°, 25*45°

RGBW 28LEDS/M 24W 24V
30°, 60°, 25*45°

AU201019WR-24VCLM-MWALL

AU201024WRW-24VCLM-MWALL

| Power | 19.2W/M 5.85W/ft | 24W/M 7.31W/ft |
|------------------|---|---|
| Voltage | DC24V | DC24V |
| CRI | / (5050LEDs) | / (5050LEDs) |
| Led Qty | 28LEDs/M 8LEDs/ft | 28LEDs/M 8LEDs/ft |
| Length/Reel | 5020mm 16.46ft | 5020mm 16.46ft |
| Cutting Length | 250mm 9.84" / 7LEDs Group | 250mm 9.84" / 7LEDs Group |
| Waterproof grade | IP67 | IP67 |
| Lumens | R 168lm/m 51lm/ft G 432lm/m 131lm/ft B 78lm/m 23lm/ft | R 168lm/m 51lm/ft G 432lm/m 131lm/ft B 78lm/m 23lm/ft W 570lm/m 173lm/ft |

Note: 'x' (CCT) = "27"(2700K) / "30"(3000K) / "40"(4000K) / "50"(5000K) / "60"(6000K), Please contact us for more information.

Dimension



Accessories

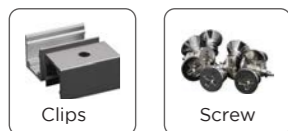

* Please contact our sales for the latest details and certifications

FLEXIBLE WALL WASHER · MINI WALL WASHER



20x10mm Mini wall washer

3030 SMD/Single white Digital/DMX control



Technical Details AU201018WW-24VCLM-MWALL-W

| Power | Voltage | CRI | Led Qty | Length/Reel | Cutting Length | Waterproof grade |
|-------------------|----------------------|----------------------|----------------------|----------------------|---|----------------------|
| 18W/M 5.49W/ft | DC24V | 80 (3030LEDs) | 24LEDs/m 7LEDs/ft | 5020mm 16.46ft | 125mm/ 3LED Group 4.92" / 3LED Group | IP67 |
| Lumens | 15° | 30° | 45° | 60° | 25x45° | 25x45x10° |
| 2700K | 1590lm/m 484lm/ft | 1570lm/m 478lm/ft | 1500lm/m 457lm/ft | 1480lm/m 451lm/ft | 1500lm/m 457lm/ft | 1480lm/m 451lm/ft |
| 3000K | 1690lm/m 515lm/ft | 1670lm/m 509lm/ft | 1650lm/m 503lm/ft | 1630lm/m 496lm/ft | 1650lm/m 503lm/ft | 1630lm/m 496lm/ft |
| 4000K | 1730lm/m 527lm/ft | 1710lm/m 521lm/ft | 1690lm/m 515lm/ft | 1670lm/m 509lm/ft | 1690lm/m 515lm/ft | 1670lm/m 509lm/ft |
| 5000K | 1760lm/m 536lm/ft | 1750lm/m 533lm/ft | 1730lm/m 527lm/ft | 1710lm/m 521lm/ft | 1730lm/m 527lm/ft | 1710lm/m 521lm/ft |

Note: 'x' (CCT) = "27"(2700K) / "30"(3000K) / "40"(4000K) / "50"(5000K) / "60"(6000K), Please contact us for more information.

Dimension

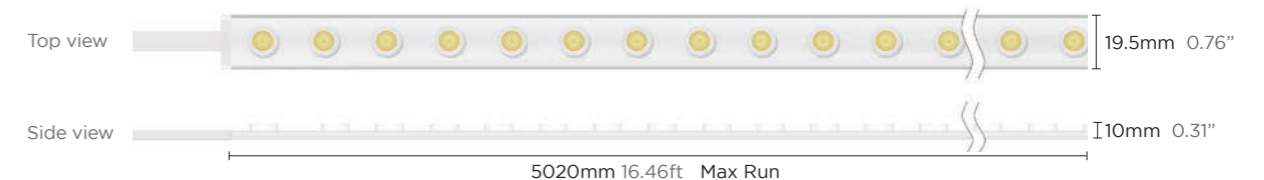

Accessories



* Please contact our sales for the latest details and certifications

FLEXIBLE WALL WASHER · MINI WALL WASHER

LED STRIP SERIES

Honor Series (24V / 12V)

2835 / 5050

Essential Series (24V / 12V)

2835 / 3528 / 5050

ErP Series

Spotless Series

2835 Reel To Reel Series

Ultra-Long Series

Mini LED Series

2110 / 2216 Plus

Colorful Series

CRI 98+

CRI 95+



Honor Series

High CRI, CRI>90;
High luminous efficiency, which up to 100lm/w;
High color consistency, SDCM<5, optional for SDCM<3

Honor Series

2835 Low Power 12V/24V



Waterproof grade

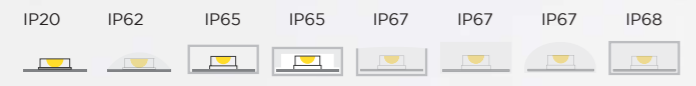

Dimension

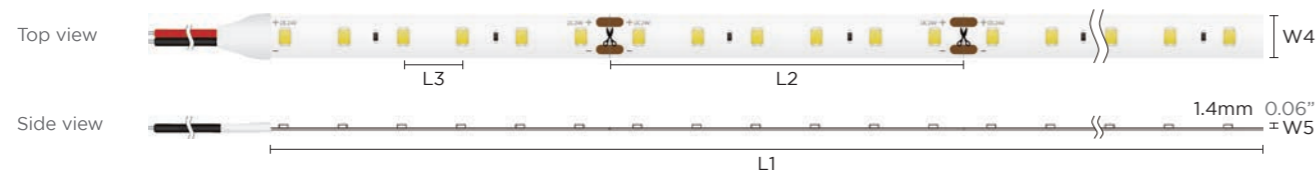

| | L1 | L2 | L3 | W4 |
|--------------------|------------|--------------|--------------|------------|
| AUHS05WW-24VCLM-LP | 5m 16.41ft | 100mm 3.94" | 16.7mm 0.66" | 8mm 0.31" |
| AUHS08WW-24VCLM-LP | 5m 16.41ft | 62.5mm 2.46" | 10.4mm 0.41" | 8mm 0.31" |
| AUHS10WW-24VCLM-LP | 5m 16.41ft | 50mm 1.97" | 8.3mm 0.33" | 8mm 0.31" |
| AUHS14WW-24VCLM-LP | 5m 16.41ft | 33.3mm 1.31" | 5.6mm 0.22" | 10mm 0.39" |
| AUHS19WW-24VCLM-LP | 5m 16.41ft | 25mm 0.98" | 4.2mm 0.17" | 10mm 0.39" |

| Technical Details | 60LEDs/M 5W 24V/12V | 96LEDs/M 8W |
|-------------------|--------------------------|--------------------------|
| | AUHS05WW-24VCLM-LP | AUHS08WW-24VCLM-LP |
| Power | 4.8W/M 1.46W/ft | 7.6W/M 2.32W/ft |
| Voltage | DC24V / DC12V | DC24V |
| CRI | 90 | 90 |
| Led Qty | 60LEDs/M 18LEDs/ft | 96LEDs/M 29LEDs/ft |
| Length/Reel | 5M 16.41ft | 5M 16.41ft |
| Waterproof grade | IP20/IP62/IP65/IP67/IP68 | IP20/IP62/IP65/IP67/IP68 |

| Technical Details | 120LEDs/M 10W 24V/12V | 180LEDs/M 14W |
|-------------------|--------------------------|--------------------------|
| | AUHS10WW-24VCLM-LP | AUHS14WW-24VCLM-LP |
| Power | 9.6W/M 2.93W/ft | 14.4W/M 4.39W/ft |
| Voltage | DC24V / DC12V | DC24V |
| CRI | 90 | 90 |
| Led Qty | 120LEDs/M 36LEDs/ft | 180LEDs/M 54LEDs/ft |
| Length/Reel | 5M 16.41ft | 5M 16.41ft |
| Waterproof grade | IP20/IP62/IP65/IP67/IP68 | IP20/IP62/IP65/IP67/IP68 |

| Technical Details | 240LEDs/M 19W |
|-------------------|--------------------------|
| | AUHS19WW-24VCLM-LP |
| Power | 19.2W/M 5.85W/ft |
| Voltage | DC24V |
| CRI | 90 |
| Led Qty | 240LEDs/M 73LEDs/ft |
| Length/Reel | 5M 16.41ft |
| Waterproof grade | IP20/IP62/IP65/IP67/IP68 |

| | Lumens | 60LEDs/M | 96LEDs/M | 120LEDs/M | 180LEDs/M | 240LEDs/M |
|---------|------------------|------------------|------------------|-------------------|-------------------|-----------|
| ● 2200K | 385lm/m 117lm/ft | 610lm/m 186lm/ft | 770lm/m 235lm/ft | 1150lm/m 351lm/ft | 1535lm/m 468lm/ft | |
| ● 2400K | 410lm/m 125lm/ft | 645lm/m 197lm/ft | 820lm/m 250lm/ft | 1220lm/m 372lm/ft | 1630lm/m 497lm/ft | |
| ● 2700K | 455lm/m 139lm/ft | 720lm/m 220lm/ft | 910lm/m 277lm/ft | 1370lm/m 418lm/ft | 1820lm/m 555lm/ft | |
| ● 3000K | 480lm/m 146lm/ft | 760lm/m 232lm/ft | 960lm/m 293lm/ft | 1440lm/m 439lm/ft | 1920lm/m 585lm/ft | |
| ● 4000K | 490lm/m 149lm/ft | 775lm/m 236lm/ft | 980lm/m 299lm/ft | 1470lm/m 448lm/ft | 1960lm/m 598lm/ft | |
| ● 5000K | 490lm/m 149lm/ft | 775lm/m 236lm/ft | 980lm/m 299lm/ft | 1470lm/m 448lm/ft | 1960lm/m 598lm/ft | |
| ● 6500K | 490lm/m 149lm/ft | 775lm/m 236lm/ft | 980lm/m 299lm/ft | 1470lm/m 448lm/ft | 1960lm/m 598lm/ft | |

Note: 'x' (CCT) = "27"(2700K) / "30"(3000K) / "40"(4000K) / "50"(5000K) / "60"(6000K), Please contact us for more information.

* Please contact our sales for the latest details and certifications

Connectors List

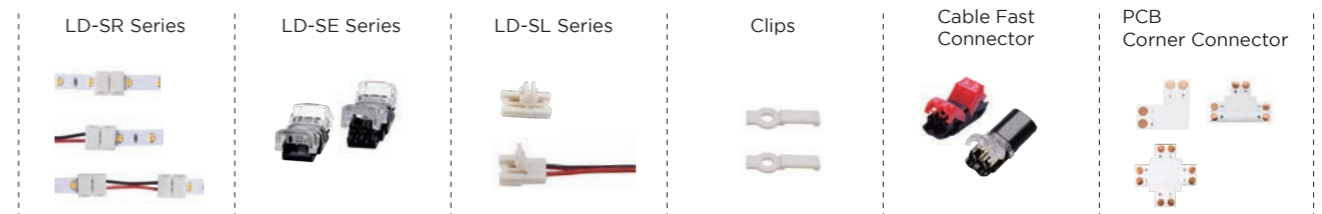

* Please Go to page 248 for Accessory and Connector Usage Guidelines.

Honor Series

2835 Regular Power 12V/24V

High CRI, CRI>90;
High luminous efficiency, which up to 100lm/w;
High color consistency, SDCM<5, optional for SDCM<3



Waterproof grade

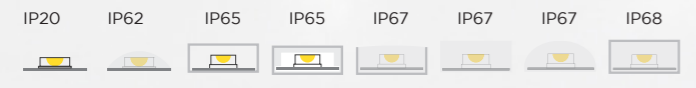

Connectors List



* Please Go to page 248 for Accessory and Connector Usage Guidelines.

| Technical Details | 30LEDs/M 8W | 60LEDs/M 10W 24V/12V |
|-------------------|--------------------------|--------------------------|
| | AUHS08WW-24VCLM-RP | AUHS10WW-24VCLM-RP |
| Power | 8.5W/M 2.59W/ft | 10W/M 3.05W/ft |
| Voltage | DC24V | DC24V / DC12V |
| CRI | 90 | 90 |
| Led Qty | 30LEDs/M 9LEDs/ft | 60LEDs/M 18LEDs/ft |
| Length/Reel | 5M 16.41ft | 5M 16.41ft |
| Waterproof grade | IP20/IP62/IP65/IP67/IP68 | IP20/IP62/IP65/IP67/IP68 |

| Technical Details | 60LEDs/M 14W 24V/12V | 120LEDs/M 19W 24V/12V |
|-------------------|--------------------------|--------------------------|
| | AUHS14WW-24VCLM-RP | AUHS19WW-24VCLM-RP |
| Power | 14.4W/M 4.39W/ft | 19.2W/M 5.85W/ft |
| Voltage | DC24V / DC12V | DC24V / DC12V |
| CRI | 90 | 90 |
| Led Qty | 60LEDs/M 18LEDs/ft | 120LEDs/M 36LEDs/ft |
| Length/Reel | 5M 16.41ft | 5M 16.41ft |
| Waterproof grade | IP20/IP62/IP65/IP67/IP68 | IP20/IP62/IP65/IP67/IP68 |

| Lumens | 30LEDs/M | | 60LEDs/M | | 60LEDs/M | | 120LEDs/M | |
|---------|----------|----------|----------|----------|----------|----------|-----------|----------|
| ● 2200K | 550lm/m | 168lm/ft | 780lm/m | 238lm/ft | 1000lm/m | 305lm/ft | 1550lm/m | 473lm/ft |
| ● 2400K | 600lm/m | 183lm/ft | 870lm/m | 265lm/ft | 1060lm/m | 323lm/ft | 1730lm/m | 527lm/ft |
| ● 2700K | 660lm/m | 201lm/ft | 910lm/m | 277lm/ft | 1180lm/m | 360lm/ft | 1800lm/m | 549lm/ft |
| ● 3000K | 680lm/m | 207lm/ft | 950lm/m | 290lm/ft | 1210lm/m | 369lm/ft | 1870lm/m | 570lm/ft |
| ● 4000K | 720lm/m | 220lm/ft | 1000lm/m | 305lm/ft | 1350lm/m | 412lm/ft | 1970lm/m | 601lm/ft |
| ● 5000K | 720lm/m | 220lm/ft | 1000lm/m | 305lm/ft | 1350lm/m | 412lm/ft | 1970lm/m | 601lm/ft |
| ● 6500K | 700lm/m | 213lm/ft | 990lm/m | 302lm/ft | 1320lm/m | 402lm/ft | 1920lm/m | 585lm/ft |

Note: 'x' (CCT) = "27"(2700K) / "30"(3000K) / "40"(4000K) / "50"(5000K) / "60"(6000K), Please contact us for more information.

* Please contact our sales for the latest details and certifications

Dimension

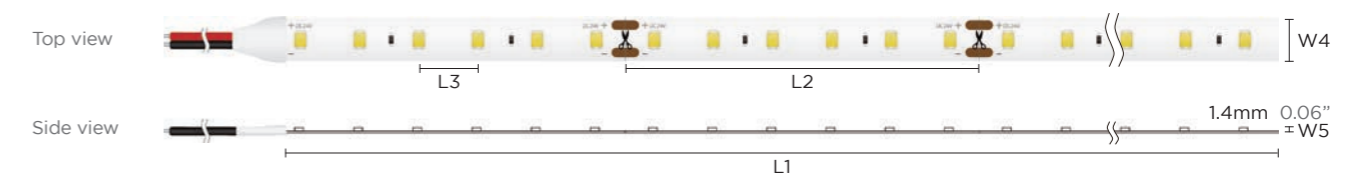

| | L1 | L2 | L3 | W4 |
|--------------------|------------|---------------|--------------|------------|
| AUHS08WW-24VCLM-RP | 5m 16.41ft | 166.7mm 6.56" | 33.3mm 1.31" | 8mm 0.31" |
| AUHS10WW-24VCLM-RP | 5m 16.41ft | 100mm 3.94" | 16.7mm 0.66" | 8mm 0.31" |
| AUHS14WW-24VCLM-RP | 5m 16.41ft | 100mm 3.94" | 16.7mm 0.66" | 10mm 0.39" |
| AUHS19WW-24VCLM-RP | 5m 16.41ft | 50mm 1.97" | 8.3mm 0.33" | 10mm 0.39" |

Honor Series

2835 Mini Cut 12V/24V

Mini cut unit down to 8.33mm.
12V / 24V voltage for option.
Different color temperature are available.



LED STRIP SERIES · HONOR SERIES



| Technical Details | 60LEDs/M 12V/24V AUHS07WW-24VCLM-MC | 120LEDs/M 12V/24V AUHS10WW-24VCLM-MC |
|-------------------|--|---|
| | Power | 7.2W/M 2.19W/ft |
| Voltage | DC24V / DC12V | DC24V / DC12V |
| CRI | 90 | 90 |
| Led Qty | 60LEDs/M 18LEDs/ft | 120LEDs/M 36LEDs/ft |
| Length/Reel | 5M 16.41ft | 5M 16.41ft |
| Waterproof grade | IP20 | IP20 |

| Lumens | 60LEDs | 120LEDs |
|---------|------------------|------------------|
| ● 2700K | 580lm/m 177lm/ft | 750lm/m 229lm/ft |
| ● 3000K | 650lm/m 198lm/ft | 820lm/m 250lm/ft |
| ● 4000K | 700lm/m 213lm/ft | 900lm/m 274lm/ft |
| ● 5000K | 680lm/m 207lm/ft | 860lm/m 262lm/ft |
| ● 6000K | 670lm/m 204lm/ft | 850lm/m 259lm/ft |

Note: 'x' (CCT) = "27"(2700K) / "30"(3000K) / "40"(4000K) / "50"(5000K) / "60"(6000K), Please contact us for more information.
* Please contact our sales for the latest details and certifications

Dimension

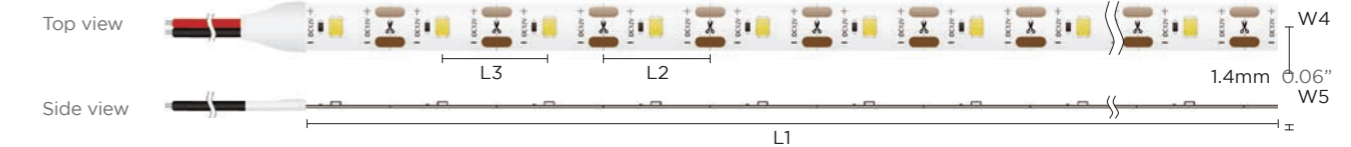

| | L1 | L2 | L3 | W4 |
|--------------------|------------|--------------|--------------|-----------|
| AUHS07WW-24VCLM-MC | 5m 16.41ft | 16.7mm 0.65" | 16.7mm 0.65" | 8mm 0.31" |
| AUHS10WW-24VCLM-MC | 5m 16.41ft | 8.3mm 0.32" | 8.3mm 0.32" | 8mm 0.31" |

Connectors List

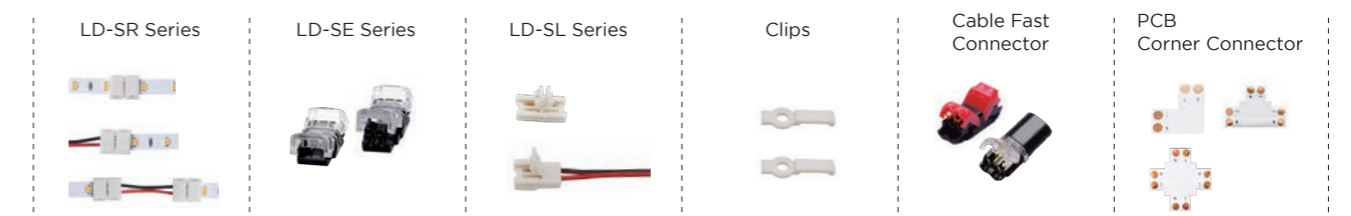

* Please Go to page 248 for Accessory and Connector Usage Guidelines.

LED STRIP SERIES · HONOR SERIES

Honor Series

5050 12V/24V

High CRI; CRI>90.
High efficiency, Up to 100lm/w.
High color consistency, within 5 steps SDCM(3 steps Optional).



Waterproof grade

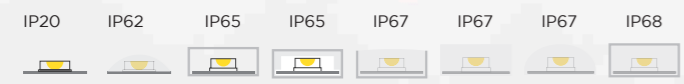

| Technical Details | 30LEDs/M | 60LEDs/M |
|-------------------|--------------------------|--------------------------|
| | AUHS08WW-24VCLM-5050 | AUHS14WW-24VCLM-5050 |
| Power | 8.5W/M 2.59W/ft | 14.4W/M 4.39W/ft |
| Voltage | DC24V | DC24V |
| CRI | 90 | 90 |
| Led Qty | 30LEDs/M 9LEDs/ft | 60LEDs/M 18LEDs/ft |
| Length/Reel | 5M 16.41ft | 5M 16.41ft |
| Waterproof grade | IP20/IP62/IP65/IP67/IP68 | IP20/IP62/IP65/IP67/IP68 |
| Lumens | 30LEDs | 60LEDs |
| ● 2200K | 460lm/m 140lm/ft | 930lm/m 284lm/ft |
| ● 2400K | 540lm/m 165lm/ft | 1080lm/m 329lm/ft |
| ● 2700K | 620lm/m 189lm/ft | 1260lm/m 384lm/ft |
| ● 3000K | 630lm/m 192lm/ft | 1280lm/m 390lm/ft |
| ● 4000K | 710lm/m 216lm/ft | 1410lm/m 430lm/ft |
| ● 5000K | 710lm/m 216lm/ft | 1410lm/m 430lm/ft |
| ● 6500K | 660lm/m 201lm/ft | 1320lm/m 402lm/ft |

Note: "x" (CCT) = "27"(2700K) / "30"(3000K) / "40"(4000K) / "50"(5000K) / "60"(6000K), Please contact us for more information.

* Please contact our sales for the latest details and certifications

Dimension

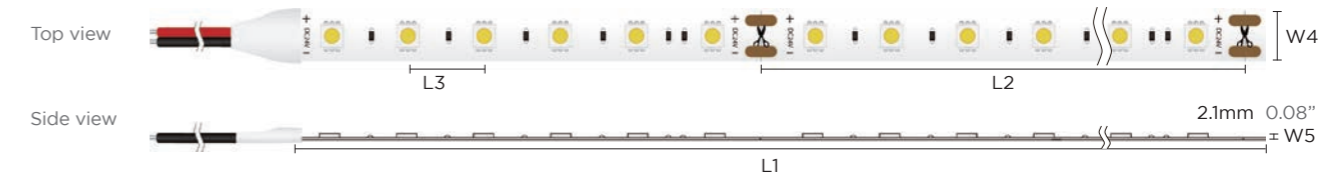

| | L1 | L2 | L3 | W4 |
|----------------------|------------|---------------|--------------|------------|
| AUHS08WW-24VCLM-5050 | 5m 16.41ft | 166.7mm 6.56" | 33.3mm 1.31" | 10mm 0.39" |
| AUHS14WW-24VCLM-5050 | 5m 16.41ft | 100mm 3.94" | 16.7mm 0.66" | 10mm 0.39" |

Connectors List

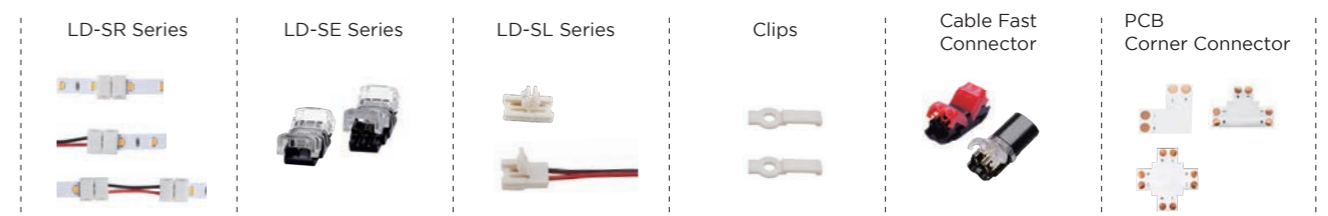

* Please Go to page 248 for Accessory and Connector Usage Guidelines.

Essential Series

High CRI, CRI>90;
High luminous efficiency, up to 100lm/w;
High color consistency, SDCM<5, optional for SDCM<3

Essential Series

2835 Low Power

Independent LED packaging , high quality;
High efficiency, up to 100 lm/W;
2200-6000K, Color temperatures are available.



Waterproof grade

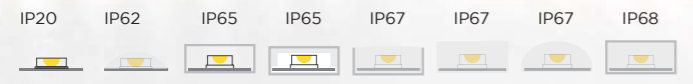

Dimension

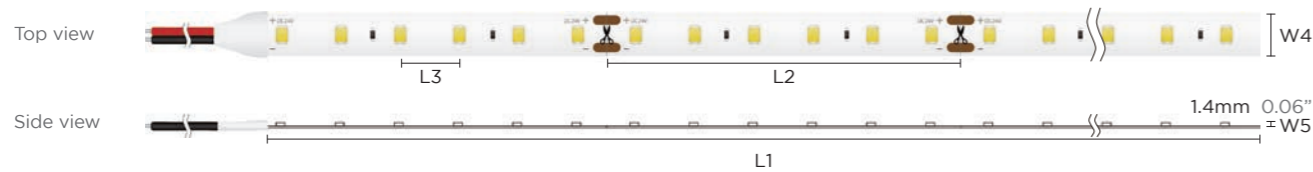

| | L1 | L2 | L3 | W4 |
|-------------------------|------------|--------------|--------------|------------|
| AUES04WW-24VCLM-CRI8-LP | 5m 16.41ft | 100mm 3.94" | 16.7mm 0.66" | 8mm 0.31" |
| AUES09WW-24VCLM-CRI8-LP | 5m 16.41ft | 50mm 1.97" | 8.3mm 0.33" | 8mm 0.31" |
| AUES14WW-24VCLM-CRI8-LP | 5m 16.41ft | 33.3mm 1.31" | 5.6mm 0.22" | 10mm 0.39" |
| AUES19WW-24VCLM-CRI8-LP | 5m 16.41ft | 25mm 0.98" | 4.2mm 0.17" | 10mm 0.39" |
| AUES04WW-24VCLM-CRI9-LP | 5m 16.41ft | 100mm 3.94" | 16.7mm 0.66" | 8mm 0.31" |
| AUES09WW-24VCLM-CRI9-LP | 5m 16.41ft | 50mm 1.97" | 8.3mm 0.33" | 8mm 0.31" |
| AUES14WW-24VCLM-CRI9-LP | 5m 16.41ft | 33.3mm 1.31" | 5.6mm 0.22" | 10mm 0.39" |
| AUES19WW-24VCLM-CRI9-LP | 5m 16.41ft | 25mm 0.98" | 4.2mm 0.17" | 10mm 0.39" |

60LEDs/M

AUES04WW-24VCLM-CRI8-LP
AUES04WW-24VCLM-CRI9-LP

| | | |
|------------------|--------------------------|--------------------------|
| Power | 4.8W/M 1.46W/ft | 9.6W/M 2.93W/ft |
| Voltage | DC24V | DC24V |
| CRI | 80/90 | 80/90 |
| Led Qty | 60LEDs/M 18LEDs/ft | 120LEDs/M 36LEDs/ft |
| Length/Reel | 5M 16.41ft | 5M 16.41ft |
| Waterproof grade | IP20/IP62/IP65/IP67/IP68 | IP20/IP62/IP65/IP67/IP68 |

120LEDs/M

AUES09WW-24VCLM-CRI8-LP
AUES09WW-24VCLM-CRI9-LP

180LEDs/M

AUES14WW-24VCLM-CRI8-LP
AUES14WW-24VCLM-CRI9-LP

| | | |
|------------------|--------------------------|--------------------------|
| Power | 14.4W/M 4.39W/ft | 19.2W/M 5.85W/ft |
| Voltage | DC24V | DC24V |
| CRI | 80/90 | 80/90 |
| Led Qty | 180LEDs/M 54LEDs/ft | 240LEDs/M 73LEDs/ft |
| Length/Reel | 5M 16.41ft | 5M 16.41ft |
| Waterproof grade | IP20/IP62/IP65/IP67/IP68 | IP20/IP62/IP65/IP67/IP68 |

240LEDs/M

AUES19WW-24VCLM-CRI8-LP
AUES19WW-24VCLM-CRI9-LP

| Lumens | 60LEDs | | 120LEDs | | 180LEDs | | 240LEDs | |
|--------|---------------------|---------------------|----------------------|---------------------|----------------------|----------------------|----------------------|----------------------|
| | CRI80 | CRI90 | CRI80 | CRI90 | CRI80 | CRI90 | CRI80 | CRI90 |
| 2200K | 374lm/m 114lm/ft | 385lm/m 117lm/ft | 749lm/m 228lm/ft | 770lm/m 235lm/ft | 1123lm/m 342lm/ft | 1155lm/m 352lm/ft | 1498lm/m 457lm/ft | 1540lm/m 470lm/ft |
| 2400K | 403lm/m 123lm/ft | 410lm/m 125lm/ft | 806lm/m 246lm/ft | 820lm/m 250lm/ft | 1210lm/m 369lm/ft | 1230lm/m 375lm/ft | 1613lm/m 492lm/ft | 1640lm/m 500lm/ft |
| 2700K | 451lm/m 138lm/ft | 455lm/m 139lm/ft | 902lm/m 275lm/ft | 910lm/m 277lm/ft | 1354lm/m 413lm/ft | 1365lm/m 416lm/ft | 1805lm/m 550lm/ft | 1820lm/m 555lm/ft |
| 3000K | 466lm/m 142lm/ft | 475lm/m 145lm/ft | 931lm/m 284lm/ft | 950lm/m 290lm/ft | 1397lm/m 426lm/ft | 1365lm/m 416lm/ft | 1862lm/m 568lm/ft | 1900lm/m 579lm/ft |
| 4000K | 509lm/m 155lm/ft | 480lm/m 146lm/ft | 1018lm/m 310lm/ft | 960lm/m 293lm/ft | 1526lm/m 465lm/ft | 1400lm/m 427lm/ft | 2035lm/m 620lm/ft | 1920lm/m 585lm/ft |
| 5000K | 490lm/m 149lm/ft | 480lm/m 146lm/ft | 979lm/m 298lm/ft | 960lm/m 293lm/ft | 1469lm/m 448lm/ft | 1400lm/m 427lm/ft | 1958lm/m 597lm/ft | 1920lm/m 585lm/ft |
| 6500K | 480lm/m 146lm/ft | 480lm/m 146lm/ft | 960lm/m 293lm/ft | 960lm/m 293lm/ft | 1440lm/m 439lm/ft | 1400lm/m 427lm/ft | 1920lm/m 585lm/ft | 1920lm/m 585lm/ft |

* Please contact our sales for the latest details and certifications

Note: 'x' (CCT) = "27"(2700K) / "30"(3000K) / "40"(4000K) / "50"(5000K) / "60"(6000K), Please contact us for more information.

Connectors List

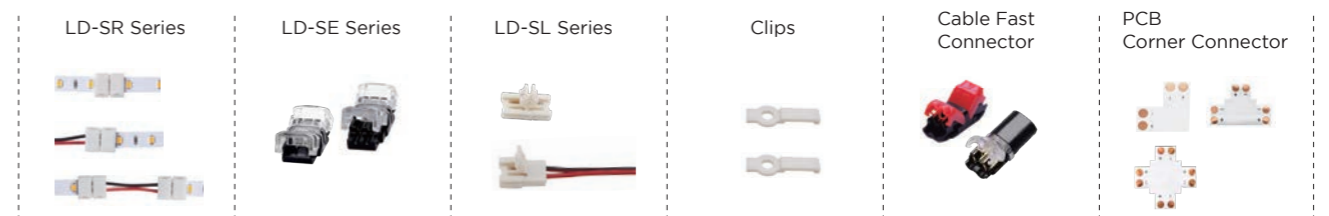

* Please Go to page 248 for Accessory and Connector Usage Guidelines.

Essential Series

2835 Regular Power



Waterproof grade

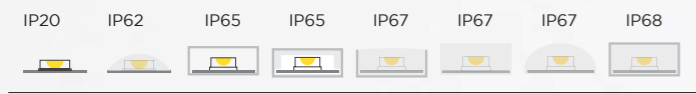

Dimension

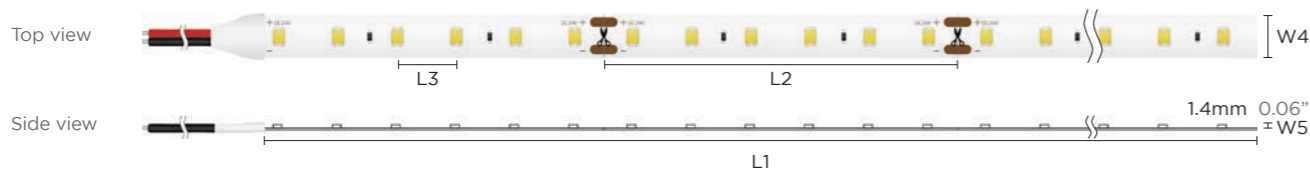

| | L1 | L2 | L3 | W4 |
|-------------------------|------------|-------------|--------------|------------|
| AUES10WW-24VCLM-CRI8-RP | 5m 16.41ft | 100mm 3.94" | 16.7mm 0.66" | 8mm 0.31" |
| AUES14WW-24VCLM-CRI8-RP | 5m 16.41ft | 100mm 3.94" | 16.7mm 0.66" | 10mm 0.39" |
| AUES19WW-24VCLM-CRI8-RP | 5m 16.41ft | 50mm 1.97" | 8.3mm 0.33" | 10mm 0.39" |
| AUES10WW-24VCLM-CRI9-RP | 5m 16.41ft | 100mm 3.94" | 16.7mm 0.66" | 8mm 0.31" |
| AUES14WW-24VCLM-CRI9-RP | 5m 16.41ft | 100mm 3.94" | 16.7mm 0.66" | 10mm 0.39" |
| AUES19WW-24VCLM-CRI9-RP | 5m 16.41ft | 50mm 1.97" | 8.3mm 0.33" | 10mm 0.39" |

60LEDs/M 10W CRI80

AUES10WW-24VCLM-CRI8-RP

| | |
|------------------|--------------------------|
| Power | 10W/M 3.05W/ft |
| Voltage | DC24V |
| CRI | 80 |
| Led Qty | 60LEDs/M 18LEDs/ft |
| Length/Reel | 5M 16.41ft |
| Waterproof grade | IP20/IP62/IP65/IP67/IP68 |

60LEDs/M 10W CRI90

AUES10WW-24VCLM-CRI9-RP

| | |
|------------------|--------------------------|
| Power | 10W/M 3.05W/ft |
| Voltage | DC24V |
| CRI | 90 |
| Led Qty | 60LEDs/M 18LEDs/ft |
| Length/Reel | 5M 16.41ft |
| Waterproof grade | IP20/IP62/IP65/IP67/IP68 |

60LEDs/M 14.4W CRI80

AUES14WW-24VCLM-CRI8-RP

| | |
|------------------|--------------------------|
| Power | 14.4W/M 4.39W/ft |
| Voltage | DC24V |
| CRI | 80 |
| Led Qty | 60LEDs/M 18LEDs/ft |
| Length/Reel | 5M 16.41ft |
| Waterproof grade | IP20/IP62/IP65/IP67/IP68 |

60LEDs/M 14.4W CRI90

AUES14WW-24VCLM-CRI9-RP

| | |
|------------------|--------------------------|
| Power | 14.4W/M 4.39W/ft |
| Voltage | DC24V |
| CRI | 90 |
| Led Qty | 60LEDs/M 18LEDs/ft |
| Length/Reel | 5M 16.41ft |
| Waterproof grade | IP20/IP62/IP65/IP67/IP68 |

120LEDs/M 19.2W CRI80

AUES19WW-24VCLM-CRI8-RP

| | |
|------------------|--------------------------|
| Power | 19.2W/M 5.85W/ft |
| Voltage | DC24V |
| CRI | 80 |
| Led Qty | 120LEDs/M 36LEDs/ft |
| Length/Reel | 5M 16.41ft |
| Waterproof grade | IP20/IP62/IP65/IP67/IP68 |

120LEDs/M 19.2W CRI90

AUES19WW-24VCLM-CRI9-RP

| | |
|------------------|--------------------------|
| Power | 19.2W/M 5.85W/ft |
| Voltage | DC24V |
| CRI | 90 |
| Led Qty | 120LEDs/M 36LEDs/ft |
| Length/Reel | 5M 16.41ft |
| Waterproof grade | IP20/IP62/IP65/IP67/IP68 |

| Power | 10W 60LEDs | | 14.4W 60LEDs | | 19.2W 120LEDs | |
|-------|-------------------|------------------|-------------------|-------------------|-------------------|-------------------|
| | CRI80 | CRI90 | CRI80 | CRI90 | CRI80 | CRI90 |
| 2200K | 780lm/m 238lm/ft | 750lm/m 229lm/ft | 1123lm/m 342lm/ft | 1050lm/m 320lm/ft | 1498lm/m 457lm/ft | 1440lm/m 439lm/ft |
| 2400K | 840lm/m 256lm/ft | 800lm/m 244lm/ft | 1210lm/m 369lm/ft | 1120lm/m 341lm/ft | 1613lm/m 492lm/ft | 1535lm/m 468lm/ft |
| 2700K | 940lm/m 287lm/ft | 900lm/m 274lm/ft | 1354lm/m 413lm/ft | 1250lm/m 381lm/ft | 1805lm/m 550lm/ft | 1730lm/m 527lm/ft |
| 3000K | 970lm/m 296lm/ft | 950lm/m 290lm/ft | 1397lm/m 426lm/ft | 1325lm/m 404lm/ft | 1862lm/m 568lm/ft | 1820lm/m 555lm/ft |
| 4000K | 1060lm/m 323lm/ft | 980lm/m 299lm/ft | 1526lm/m 465lm/ft | 1370lm/m 418lm/ft | 2035lm/m 620lm/ft | 1880lm/m 573lm/ft |
| 5000K | 1020lm/m 311lm/ft | 980lm/m 299lm/ft | 1469lm/m 448lm/ft | 1370lm/m 418lm/ft | 1958lm/m 597lm/ft | 1880lm/m 573lm/ft |
| 6500K | 1000lm/m 305lm/ft | 980lm/m 299lm/ft | 1440lm/m 439lm/ft | 1370lm/m 418lm/ft | 1920lm/m 585lm/ft | 1880lm/m 573lm/ft |

Note: 'x' (CCT) = "27"(2700K) / "30"(3000K) / "40"(4000K) / "50"(5000K) / "60"(6000K), Please contact us for more information.

* Please contact our sales for the latest details and certifications

Connectors List

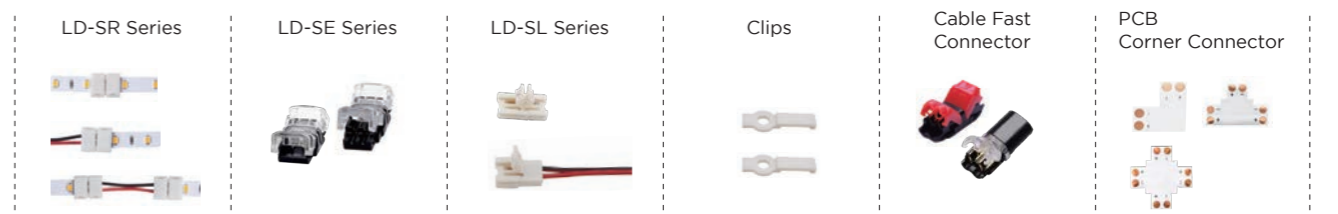

* Please Go to page 248 for Accessory and Connector Usage Guidelines.

Essential Series

3528 12V/24V

High CRI; CRI>95.
High Efficiency, Up to 100lm/w.
High color consistency, within 5 steps SDCM(3 steps Optional).

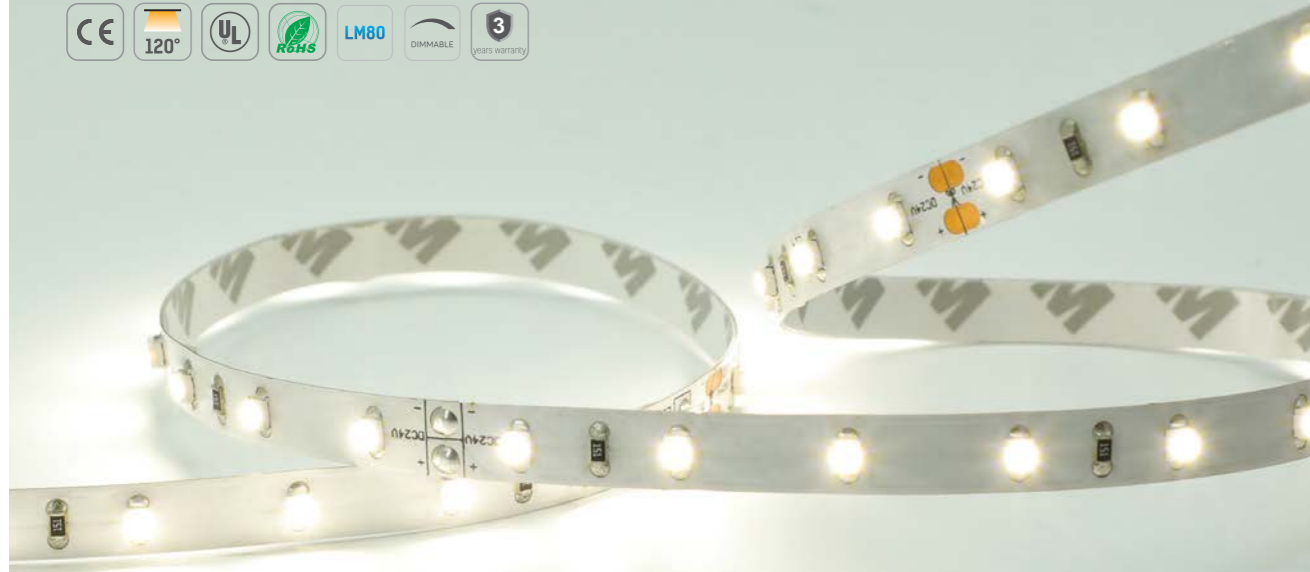

Waterproof grade

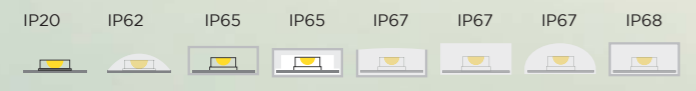

Connectors List

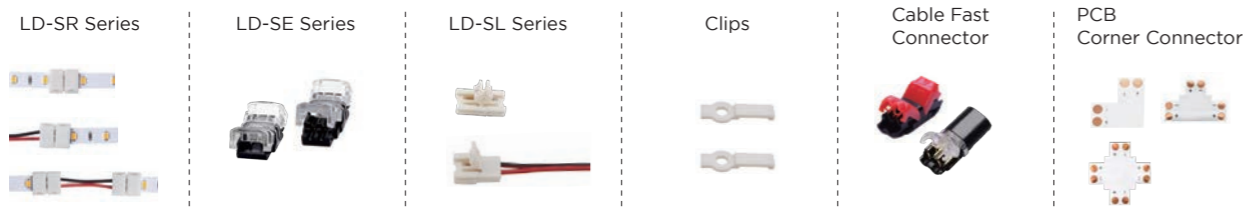

* Please Go to page 248 for Accessory and Connector Usage Guidelines.

LED STRIP SERIES · ESSENTIAL SERIES

LED STRIP SERIES · ESSENTIAL SERIES

| Technical Details | 30LEDs/M | 60LEDs/M |
|-------------------|-----------------------------|--------------------------|
| | AUES02WW-24VCLM-CRI95 | AUES04WW-24VCLM-CRI95 |
| Power | 2.4W/M 0.73W/ft | 4.8W/M 1.46W/ft |
| Voltage | DC24V / DC12V | DC24V / DC12V |
| CRI | 95 | 95 |
| Led Qty | 30LEDs/M 9LEDs/ft | 60LEDs/M 18LEDs/ft |
| Cutting Length | 166.6mm 6.56" / 100mm 3.94" | 100mm 3.94" / 50mm 1.97" |
| Length/Reel | 5M 16.41ft | 5M 16.41ft |
| Waterproof grade | IP20/IP62/IP65/IP67/IP68 | IP20/IP62/IP65/IP67/IP68 |

| Technical Details | 120LEDs/M |
|-------------------|--------------------------|
| | AUES09WW-24VCLM-CRI95 |
| Power | 9.6W/M 2.93W/ft |
| Voltage | DC24V / DC12V |
| CRI | 95 |
| Led Qty | 120LEDs/M 37LEDs/ft |
| Cutting Length | 50mm 1.97" / 25mm 0.98" |
| Length/Reel | 5M 16.41ft |
| Waterproof grade | IP20/IP62/IP65/IP67/IP68 |

| Lumens | 30LEDs | | 60LEDs | | 60LEDs | |
|---------|---------|---------|---------|----------|----------|----------|
| | ● 2400K | 160lm/m | 49lm/ft | 330lm/m | 101lm/ft | 660lm/m |
| ● 2700K | 165lm/m | 50lm/ft | 340lm/m | 104lm/ft | 680lm/m | 207lm/ft |
| ● 3000K | 170lm/m | 52lm/ft | 350lm/m | 107lm/ft | 700lm/m | 213lm/ft |
| ● 4000K | 175lm/m | 53lm/ft | 360lm/m | 110lm/ft | 720lm/m | 220lm/ft |
| ● 5000K | 180lm/m | 55lm/ft | 400lm/m | 122lm/ft | 800lm/m | 244lm/ft |
| ● 6500K | 170lm/m | 52lm/ft | 350lm/m | 107lm/ft | 700lm/m | 213lm/ft |

Note: 'x' (CCT) = "27"(2700K) / "30"(3000K) / "40"(4000K) / "50"(5000K) / "60"(6000K), Please contact us for more information.

Dimension



| | L1 | L2 | W3 | W4 |
|-----------------------|------------|---------------|-----------|-------------|
| AUES02WW-24VCLM-CRI95 | 5m 16.41ft | 27.77mm 1.09" | 8mm 0.32" | 2.1mm 0.08" |
| AUES04WW-24VCLM-CRI95 | 5m 16.41ft | 16.67mm 0.66" | 8mm 0.32" | 2.1mm 0.08" |
| AUES09WW-24VCLM-CRI95 | 5m 16.41ft | 8.33mm 0.33" | 8mm 0.32" | 2.1mm 0.08" |
| AUES02WW-24VCLM-CRI95 | 5m 16.41ft | 33.33mm 1.31" | 8mm 0.32" | 2.1mm 0.08" |
| AUES04WW-24VCLM-CRI95 | 5m 16.41ft | 16.67mm 0.66" | 8mm 0.32" | 2.1mm 0.08" |
| AUES09WW-24VCLM-CRI95 | 5m 16.41ft | 8.33mm 0.33" | 8mm 0.32" | 2.1mm 0.08" |

Essential Series

5050

High CRI; CRI>90.
High efficiency, Up to 100lm/w.
High color consistency, within 5 steps SDCM(3 steps Optional).



Waterproof grade

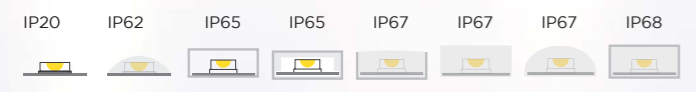

Connectors List

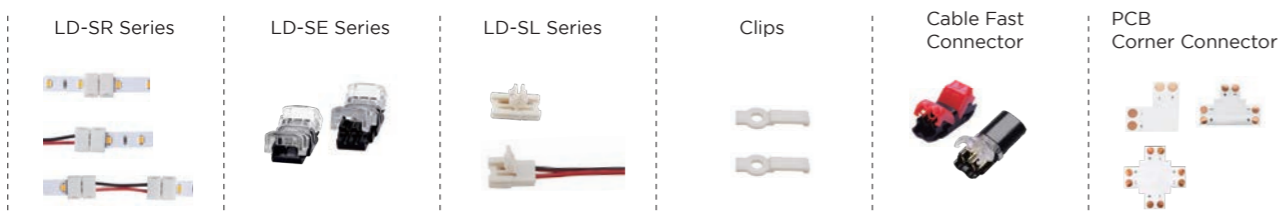

* Please Go to page 248 for Accessory and Connector Usage Guidelines.

| Technical Details | 30LEDs/M CRI80 | 30LEDs/M CRI90 |
|-------------------|---------------------------|---------------------------|
| | AUES06WW-24VCLM-CRI8-5050 | AUES07WW-24VCLM-CRI9-5050 |
| Power | 6W/M 1.82W/ft | 7.2W/M 2.19W/ft |
| Voltage | DC24V | DC24V |
| CRI | 80 | 90 |
| Led Qty | 30LEDs/M 9LEDs/ft | 30LEDs/M 9LEDs/ft |
| Length/Reel | 5M 16.41ft | 5M 16.41ft |
| Waterproof grade | IP20/IP62/IP65/IP67/IP68 | IP20/IP62/IP65/IP67/IP68 |

| Technical Details | 60LEDs/M CRI80 | 60LEDs/M CRI90 |
|-------------------|---------------------------|---------------------------|
| | AUES12WW-24VCLM-CRI8-5050 | AUES14WW-24VCLM-CRI9-5050 |
| Power | 12W/M 3.65W/ft | 14.4W/M 4.39W/ft |
| Voltage | DC24V | DC24V |
| CRI | 80 | 90 |
| Led Qty | 60LEDs/M 18LEDs/ft | 60LEDs/M 18LEDs/ft |
| Length/Reel | 5M 16.41ft | 5M 16.41ft |
| Waterproof grade | IP20/IP62/IP65/IP67/IP68 | IP20/IP62/IP65/IP67/IP68 |

| Power | 6W 30LEDs | | 7W 30LEDs | | 12W 60LEDs | | 14W 60LEDs | |
|---------|-----------|----------|-----------|----------|------------|----------|------------|----------|
| | CRI80 | | CRI90 | | CRI80 | | CRI90 | |
| ● 2200K | 420lm/m | 128lm/ft | 440lm/m | 134lm/ft | 966lm/m | 295lm/ft | 1015lm/m | 309lm/ft |
| ● 2400K | 456lm/m | 139lm/ft | 480lm/m | 146lm/ft | 1049lm/m | 320lm/ft | 1100lm/m | 335lm/ft |
| ● 2700K | 498lm/m | 152lm/ft | 530lm/m | 162lm/ft | 1145lm/m | 349lm/ft | 1200lm/m | 366lm/ft |
| ● 3000K | 510lm/m | 155lm/ft | 535lm/m | 163lm/ft | 1173lm/m | 358lm/ft | 1230lm/m | 375lm/ft |
| ● 4000K | 564lm/m | 172lm/ft | 590lm/m | 180lm/ft | 1297lm/m | 395lm/ft | 1360lm/m | 415lm/ft |
| ● 5000K | 558lm/m | 170lm/ft | 586lm/m | 179lm/ft | 1283lm/m | 391lm/ft | 1350lm/m | 412lm/ft |
| ● 6500K | 552lm/m | 168lm/ft | 580lm/m | 177lm/ft | 1270lm/m | 387lm/ft | 1330lm/m | 405lm/ft |

Note: 'x' (CCT) = "27"(2700K) / "30"(3000K) / "40"(4000K) / "50"(5000K) / "60"(6000K), Please contact us for more information.
* Please contact our sales for the latest details and certifications

Dimension

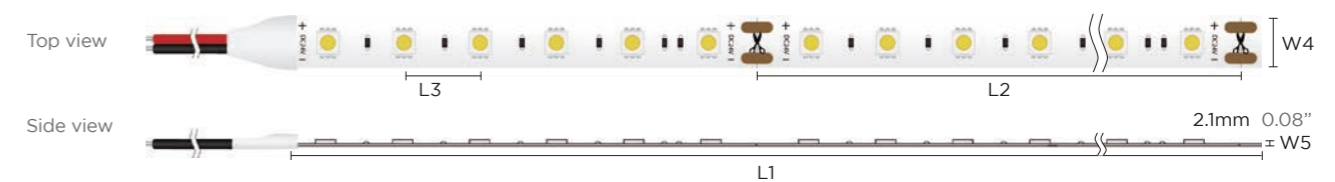

| | L1 | L2 | L3 | W4 |
|---------------------------|------------|---------------|--------------|------------|
| AUES06WW-24VCLM-CRI8-5050 | 5m 16.41ft | 166.7mm 6.56" | 33.3mm 1.31" | 10mm 0.39" |
| AUES07WW-24VCLM-CRI9-5050 | 5m 16.41ft | 166.7mm 6.56" | 33.3mm 1.31" | 10mm 0.39" |
| AUES12WW-24VCLM-CRI8-5050 | 5m 16.41ft | 100mm 3.94" | 16.7mm 0.66" | 10mm 0.39" |
| AUES14WW-24VCLM-CRI9-5050 | 5m 16.41ft | 100mm 3.94" | 16.7mm 0.66" | 10mm 0.39" |

ErP Series

Low Voltage Drop
ErP Qualified, Up to Grades B



UP TO 215 LM/W

The high light efficiency and matching of high CRI can better expand the application range of linear illumination. The ultra-high light efficiency makes the linear illumination gradually replace some of the main lighting fields from the traditional auxiliary ambient light field, and with CRI>90 or higher CRI can fully meet the demands for light in the high-end commercial lighting field. From the outline of ceiling design, creating a light environment to the traditional wall washing function, this series can fully meet the needs of linear lighting in different areas of commercial complex buildings. To achieve the ultimate light environment experience.



3/4OZ PCB



RA80+/RA90+



2700K-6000K



High Quality Chips



115-125LM/W CRI80

70LEDs/M 4.8W

Product NO. AUERP04WW-24VCLM-115LM70L



Technical Details

| Power | 4.8W/M 1.46W/ft | Lumens | | ErP Class | |
|-------------------------|---------------------------|---------|------------------|-----------|--|
| Voltage | DC24V | ● 2700K | 562lm/m 171lm/ft | F | |
| CRI | 80 | ● 3000K | 581lm/m 177lm/ft | E | |
| Led Qty | 70LEDs/M 21LEDs/ft | ● 4000K | 600lm/m 183lm/ft | E | |
| Length/Reel | 5004mm 16.41ft | ● 5000K | 590lm/m 180lm/ft | E | |
| Cutting Length | 100mm 3.93" | ● 6000K | 590lm/m 180lm/ft | E | |
| Waterproof grade | IP20 / IP62 / IP65 / IP68 | | | | |

Note: 'x' (CCT) = "27"(2700K) / "30"(3000K) / "40"(4000K) / "50"(5000K) / "60"(6000K), Please contact us for more information.

* Please contact our sales for the latest details and certifications

Dimension

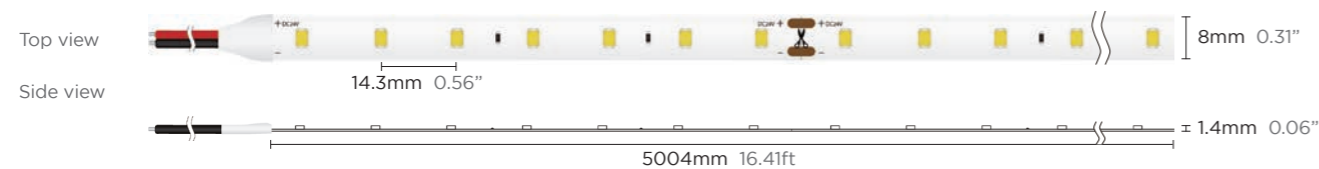

Connectors List



* Please Go to page 248 for Accessory and Connector Usage Guidelines.

115-125LM/W CRI80

140LEDs/M 9.6W

Product NO. AUERP09WW-24VCLM-115LM140L



Technical Details

| Power | 9.6W/M 2.93W/ft | Lumens | | ErP Class | |
|-------------------------|---------------------------|---------|-------------------|-----------|--|
| Voltage | DC24V | ● 2700K | 1123lm/m 342lm/ft | F | |
| CRI | 80 | ● 3000K | 1162lm/m 354lm/ft | E | |
| Led Qty | 140LEDs/M 42LEDs/ft | ● 4000K | 1200lm/m 366lm/ft | E | |
| Length/Reel | 5004mm 16.41ft | ● 5000K | 1181lm/m 360lm/ft | E | |
| Cutting Length | 50mm 1.97" | ● 6000K | 1181lm/m 360lm/ft | E | |
| Waterproof grade | IP20 / IP62 / IP65 / IP68 | | | | |

Note: 'x' (CCT) = "27"(2700K) / "30"(3000K) / "40"(4000K) / "50"(5000K) / "60"(6000K), Please contact us for more information.

* Please contact our sales for the latest details and certifications

Dimension

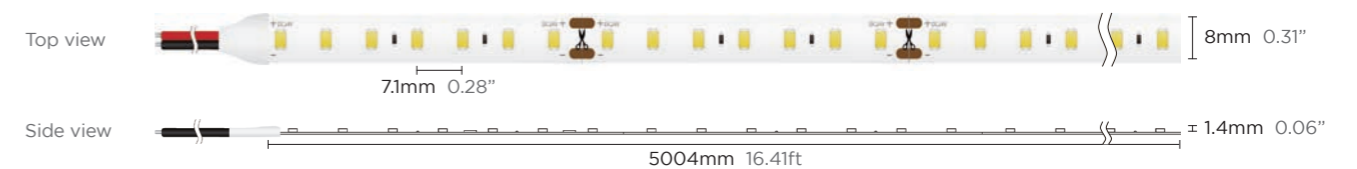

Connectors List



* Please Go to page 248 for Accessory and Connector Usage Guidelines.

115-125LM/W CRI80

210LEDs/M 14.4W

Product NO. AUERP14WW-24VCLM-115LM210L



Technical Details

| Power | 14.4W/M 4.39W/ft | Lumens | | ErP Class | |
|------------------|---------------------------|---------|-------------------|-----------|--|
| Voltage | DC24V | ● 2700K | 1685lm/m 514lm/ft | ● F | |
| CRI | 80 | ● 3000K | 1742lm/m 531lm/ft | ● E | |
| Led Qty | 210LEDs/M 64LEDs/ft | ● 4000K | 1800lm/m 549lm/ft | ● E | |
| Length/Reel | 5004mm 16.41ft | ● 5000K | 1771lm/m 540lm/ft | ● E | |
| Cutting Length | 33.3mm 1.31" | ● 6000K | 1771lm/m 540lm/ft | ● E | |
| Waterproof grade | IP20 / IP62 / IP65 / IP68 | | | | |

Note: 'x' (CCT) = "27"(2700K) / "30"(3000K) / "40"(4000K) / "50"(5000K) / "60"(6000K), Please contact us for more information.

* Please contact our sales for the latest details and certifications

Dimension

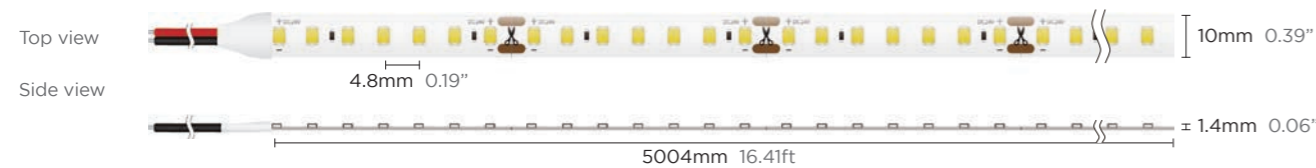

Connectors List

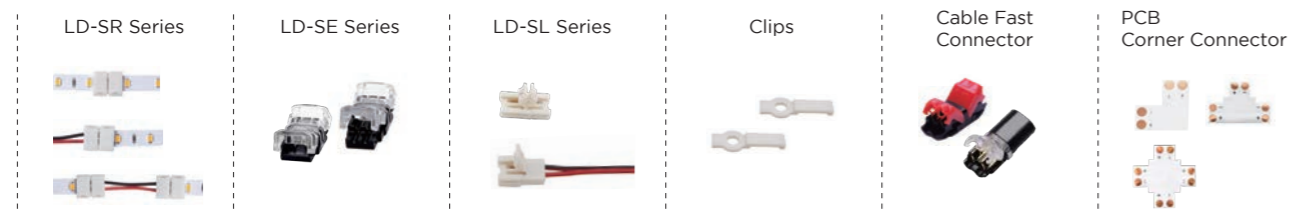

* Please Go to page 248 for Accessory and Connector Usage Guidelines.

115-125LM/W CRI80

252LEDs/M 19.2W

Product NO. AUERP19WW-24VCLM-115LM252L



Technical Details

| Power | 19.2W/M 5.85W/ft | Lumens | | ErP Class | |
|------------------|---------------------------|---------|-------------------|-----------|--|
| Voltage | DC24V | ● 2700K | 2205lm/m 672lm/ft | ● F | |
| CRI | 80 | ● 3000K | 2300lm/m 701lm/ft | ● E | |
| Led Qty | 252LEDs/M 76LEDs/ft | ● 4000K | 2360lm/m 720lm/ft | ● E | |
| Length/Reel | 5004mm 16.41ft | ● 5000K | 2360lm/m 720lm/ft | ● E | |
| Cutting Length | 27.8mm 1.09" | ● 6000K | 2360lm/m 720lm/ft | ● E | |
| Waterproof grade | IP20 / IP62 / IP65 / IP68 | | | | |

Note: 'x' (CCT) = "27"(2700K) / "30"(3000K) / "40"(4000K) / "50"(5000K) / "60"(6000K), Please contact us for more information.

* Please contact our sales for the latest details and certifications

Dimension



Connectors List



* Please Go to page 248 for Accessory and Connector Usage Guidelines.

130-145LM/W CRI80

64LEDs/M 4.8W

Product NO. AUERP04WW-24VCLM-130LM64L



Technical Details

| Power | 4.8W/M 1.46W/ft | Lumens | | | ErP Class |
|-------------------------|---------------------------|---------|---------|----------|-----------|
| Voltage | DC24V | ● 2700K | 629lm/m | 192lm/ft | E |
| CRI | 80 | ● 3000K | 648lm/m | 198lm/ft | E |
| Led Qty | 64LEDs/M 19LEDs/ft | ● 4000K | 696lm/m | 212lm/ft | E |
| Length/Reel | 5004mm 16.41ft | ● 5000K | 677lm/m | 206lm/ft | E |
| Cutting Length | 125mm 4.92" | ● 6000K | 682lm/m | 208lm/ft | E |
| Waterproof grade | IP20 / IP62 / IP65 / IP68 | | | | |

Note: 'x' (CCT) = "27"(2700K) / "30"(3000K) / "40"(4000K) / "50"(5000K) / "60"(6000K), Please contact us for more information.

* Please contact our sales for the latest details and certifications

Dimension

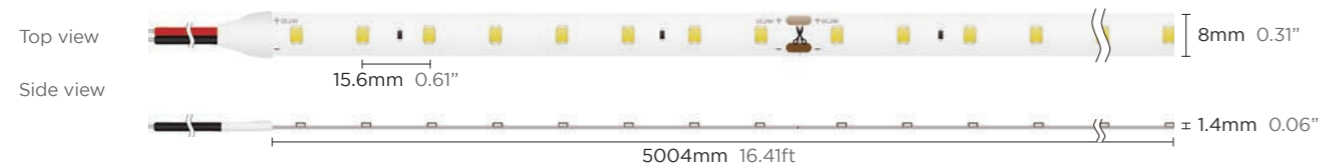

Connectors List

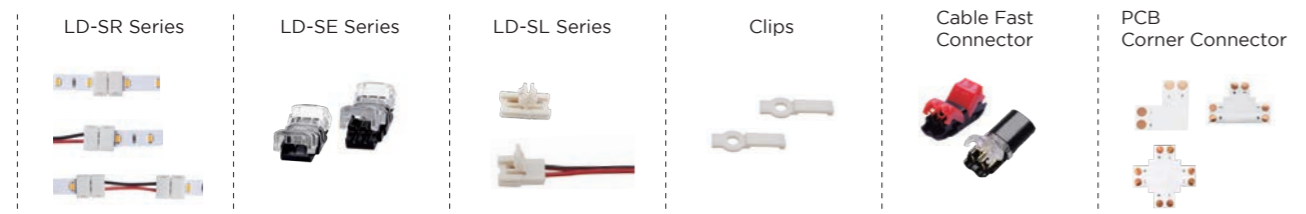

* Please Go to page 248 for Accessory and Connector Usage Guidelines.

LED STRIP SERIES · ERP SERIES

130-145LM/W CRI80

80LEDs/M 9.6W

Product NO. AUERP09WW-24VCLM-130LM80L



Technical Details

| Power | 9.6W/M 2.93W/ft | Lumens | | | ErP Class |
|-------------------------|---------------------------|---------|----------|----------|-----------|
| Voltage | DC24V | ● 2700K | 1225lm/m | 373lm/ft | E |
| CRI | 80 | ● 3000K | 1250lm/m | 381lm/ft | E |
| Led Qty | 80LEDs/M 24LEDs/ft | ● 4000K | 1300lm/m | 396lm/ft | E |
| Length/Reel | 5004mm 16.41ft | ● 5000K | 1300lm/m | 396lm/ft | E |
| Cutting Length | 100mm 3.93" | ● 6000K | 1300lm/m | 396lm/ft | E |
| Waterproof grade | IP20 / IP62 / IP65 / IP68 | | | | |

Note: 'x' (CCT) = "27"(2700K) / "30"(3000K) / "40"(4000K) / "50"(5000K) / "60"(6000K), Please contact us for more information.

* Please contact our sales for the latest details and certifications

Dimension



Connectors List



* Please Go to page 248 for Accessory and Connector Usage Guidelines.

LED STRIP SERIES · ERP SERIES

130-145LM/W CRI80

128LEDs/M 9.6W

Product NO. AUERP09WW-24VCLM-130LM128L



Technical Details

| Power | 9.6W/M 2.93W/ft | Lumens | | ErP Class | |
|-------------------------|---------------------------|---------|-------------------|-----------|---|
| Voltage | DC24V | ● 2700K | 1258lm/m 384lm/ft | ● | E |
| CRI | 80 | ● 3000K | 1296lm/m 395lm/ft | ● | E |
| Led Qty | 128LEDs/M 39LEDs/ft | ● 4000K | 1392lm/m 424lm/ft | ● | E |
| Length/Reel | 5004mm 16.41ft | ● 5000K | 1354lm/m 413lm/ft | ● | E |
| Cutting Length | 62.5mm 2.46" | ● 6000K | 1363lm/m 416lm/ft | ● | E |
| Waterproof grade | IP20 / IP62 / IP65 / IP68 | | | | |

Note: 'x' (CCT) = "27"(2700K) / "30"(3000K) / "40"(4000K) / "50"(5000K) / "60"(6000K), Please contact us for more information.

* Please contact our sales for the latest details and certifications

Dimension



Connectors List



* Please Go to page 248 for Accessory and Connector Usage Guidelines.

LED STRIP SERIES · ERP SERIES

130-145LM/W CRI80

160LEDs/M 14.4W

Product NO. AUERP14WW-24VCLM-130LM160L



Technical Details

| Power | 14.4W/M 4.39W/ft | Lumens | | ErP Class | |
|-------------------------|---------------------------|---------|-------------------|-----------|---|
| Voltage | DC24V | ● 2700K | 1885lm/m 575lm/ft | ● | E |
| CRI | 80 | ● 3000K | 1945lm/m 593lm/ft | ● | E |
| Led Qty | 160LEDs/M 48LEDs/ft | ● 4000K | 2030lm/m 619lm/ft | ● | E |
| Length/Reel | 5004mm 16.41ft | ● 5000K | 2030lm/m 619lm/ft | ● | E |
| Cutting Length | 50mm 1.96" | ● 6000K | 2030lm/m 619lm/ft | ● | E |
| Waterproof grade | IP20 / IP62 / IP65 / IP68 | | | | |

Note: 'x' (CCT) = "27"(2700K) / "30"(3000K) / "40"(4000K) / "50"(5000K) / "60"(6000K), Please contact us for more information.

* Please contact our sales for the latest details and certifications

Dimension



Connectors List



* Please Go to page 248 for Accessory and Connector Usage Guidelines.

LED STRIP SERIES · ERP SERIES

165-190LM/W RA80

64LEDs/M 4.8W

Product NO. AUERP04WW-24VCLM-165LM64L



Technical Details

| Power | 4.8W/M 1.46W/ft | Lumens | | ErP Class | | | | | | | | |
|-------------------------|---------------------------|---------|------------------|-----------|------------------|---------|------------------|---------|------------------|---------|------------------|-----|
| Voltage | DC24V | ● 2700K | 835lm/m 255lm/ft | ● 3000K | 845lm/m 258lm/ft | ● 4000K | 930lm/m 284lm/ft | ● 5000K | 930lm/m 284lm/ft | ● 6000K | 920lm/m 280lm/ft | ▶ D |
| RA | 80 | ▶ D | | ▶ D | | | | | | | | ▶ C |
| Led Qty | 64LEDs/M 19LEDs/ft | | | | | | | | | | | ▶ C |
| Length/Reel | 5004mm 16.41ft | | | | | | | | | | | ▶ C |
| Cutting Length | 125mm 4.92" | | | | | | | | | | | ▶ C |
| Waterproof grade | IP20 / IP62 / IP65 / IP68 | | | | | | | | | | | |

Note: 'x' (CCT) = "27"(2700K) / "30"(3000K) / "40"(4000K) / "50"(5000K) / "60"(6000K), Please contact us for more information.

* Please contact our sales for the latest details and certifications

Dimension

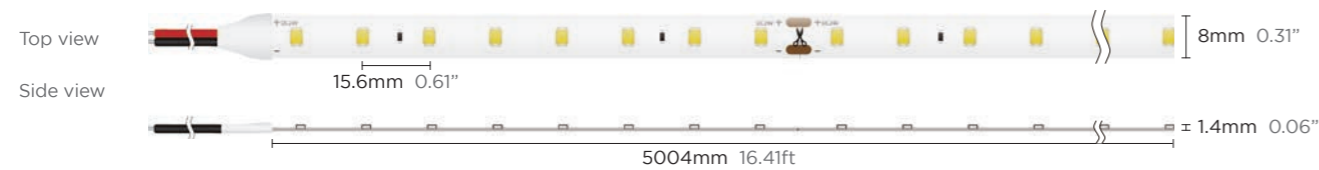

Connectors List

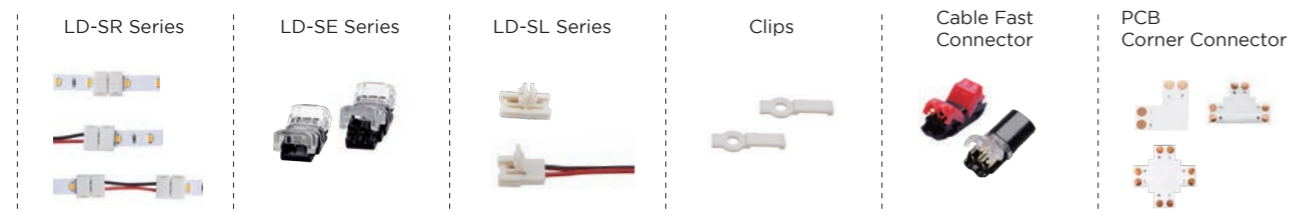

* Please Go to page 248 for Accessory and Connector Usage Guidelines.

165-190LM/W RA80

80LEDs/M 9.6W

Product NO. AUERP09WW-24VCLM-165LM80L



Technical Details

| Power | 9.6W/M 2.93W/ft | Lumens | | ErP Class | | | | | | | | |
|-------------------------|---------------------------|---------|-------------------|-----------|-------------------|---------|-------------------|---------|-------------------|---------|-------------------|-----|
| Voltage | DC24V | ● 2700K | 1620lm/m 494lm/ft | ● 3000K | 1660lm/m 506lm/ft | ● 4000K | 1810lm/m 552lm/ft | ● 5000K | 1810lm/m 552lm/ft | ● 6000K | 1775lm/m 541lm/ft | ▶ D |
| RA | 80 | ▶ D | | ▶ D | | | | | | | | ▶ C |
| Led Qty | 80LEDs/M 24LEDs/ft | | | | | | | | | | | ▶ C |
| Length/Reel | 5004mm 16.41ft | | | | | | | | | | | ▶ C |
| Cutting Length | 100mm 3.93" | | | | | | | | | | | ▶ C |
| Waterproof grade | IP20 / IP62 / IP65 / IP68 | | | | | | | | | | | |

Note: 'x' (CCT) = "27"(2700K) / "30"(3000K) / "40"(4000K) / "50"(5000K) / "60"(6000K), Please contact us for more information.

* Please contact our sales for the latest details and certifications

Dimension



Connectors List

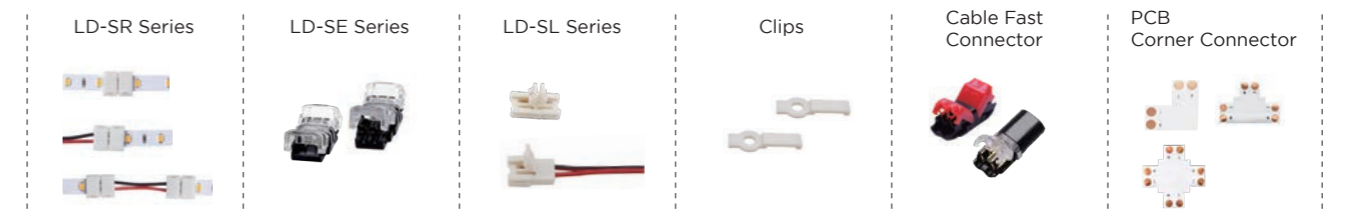

* Please Go to page 248 for Accessory and Connector Usage Guidelines.

165-190LM/W CRI80

80LEDs/M 12W

Product NO. AUERP12WW-24VCLM-165LM80L



Technical Details

| Power | 12W/M 3.65W/ft | Lumens | | ErP Class | |
|-------------------------|---------------------------|---------|-------------------|-----------|--|
| Voltage | DC24V | ● 2700K | 2100lm/m 640lm/ft | ● D | |
| CRI | 80 | ● 3000K | 2140lm/m 652lm/ft | ● C | |
| Led Qty | 80LEDs/M 24LEDs/ft | ● 4000K | 2260lm/m 689lm/ft | ● C | |
| Length/Reel | 5004mm 16.41ft | ● 5000K | 2190lm/m 668lm/ft | ● C | |
| Cutting Length | 100mm 3.93" | ● 6000K | 2160lm/m 659lm/ft | ● C | |
| Waterproof grade | IP20 / IP62 / IP65 / IP68 | | | | |

Note: 'x' (CCT) = "27"(2700K) / "30"(3000K) / "40"(4000K) / "50"(5000K) / "60"(6000K), Please contact us for more information.

* Please contact our sales for the latest details and certifications

Dimension

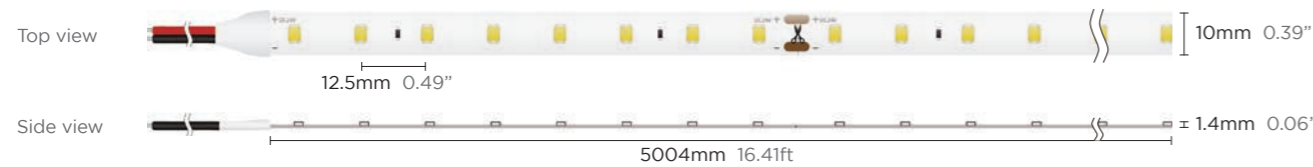

Connectors List



* Please Go to page 248 for Accessory and Connector Usage Guidelines.

LED STRIP SERIES · ERP SERIES

165-190LM/W RA80

128LEDs/M 14.4W

Product NO. AUERP14WW-24VCLM-165LM128L



Technical Details

| Power | 14.4W/M 4.39W/ft | Lumens | | ErP Class | |
|-------------------------|---------------------------|---------|-------------------|-----------|--|
| Voltage | DC24V | ● 2700K | 2400lm/m 732lm/ft | ● D | |
| RA | 80 | ● 3000K | 2445lm/m 745lm/ft | ● D | |
| Led Qty | 128LEDs/M 39LEDs/ft | ● 4000K | 2735lm/m 834lm/ft | ● C | |
| Length/Reel | 5004mm 16.41ft | ● 5000K | 2735lm/m 834lm/ft | ● C | |
| Cutting Length | 62.5mm 2.46" | ● 6000K | 2660lm/m 811lm/ft | ● C | |
| Waterproof grade | IP20 / IP62 / IP65 / IP68 | | | | |

Note: 'x' (CCT) = "27"(2700K) / "30"(3000K) / "40"(4000K) / "50"(5000K) / "60"(6000K), Please contact us for more information.

* Please contact our sales for the latest details and certifications

Dimension



Connectors List



* Please Go to page 248 for Accessory and Connector Usage Guidelines.

LED STRIP SERIES · ERP SERIES

165-190LM/W RA80

160LEDs/M 19.2W

Product NO. AUERP19WW-24VCLM-165LM160L



Technical Details

| Power | 19.2W/M 5.85W/ft | Lumens | | ErP Class | |
|-------------------------|---------------------------|---------|--------------------|-----------|--|
| Voltage | DC24V | ● 2700K | 3170lm/m 966lm/ft | ▶ D | |
| RA | 80 | ● 3000K | 3320lm/m 1012lm/ft | ▶ D | |
| Led Qty | 160LEDs/M 48LEDs/ft | ● 4000K | 3625lm/m 1105lm/ft | ▶ C | |
| Length/Reel | 5004mm 16.41ft | ● 5000K | 3625lm/m 1105lm/ft | ▶ C | |
| Cutting Length | 50mm 1.96" | ● 6000K | 3550lm/m 1082lm/ft | ▶ C | |
| Waterproof grade | IP20 / IP62 / IP65 / IP68 | | | | |

Note: 'x' (CCT) = "27"(2700K) / "30"(3000K) / "40"(4000K) / "50"(5000K) / "60"(6000K), Please contact us for more information.

* Please contact our sales for the latest details and certifications

Dimension

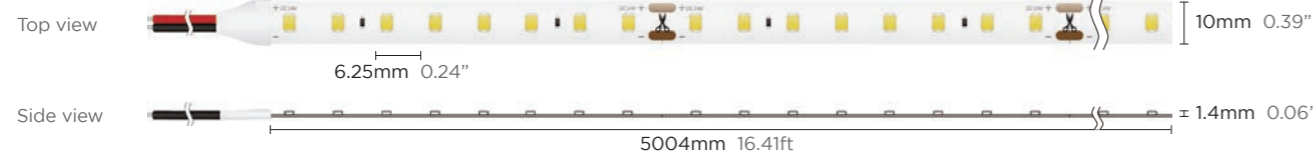

Connectors List

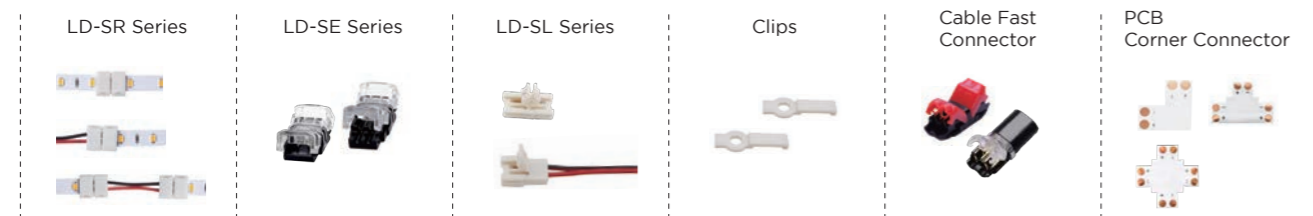

* Please Go to page 248 for Accessory and Connector Usage Guidelines.



200-215LM/W RA80

90LEDs/M 4.8W

Product NO. AUERP04WW-24VCLM-200LM90L

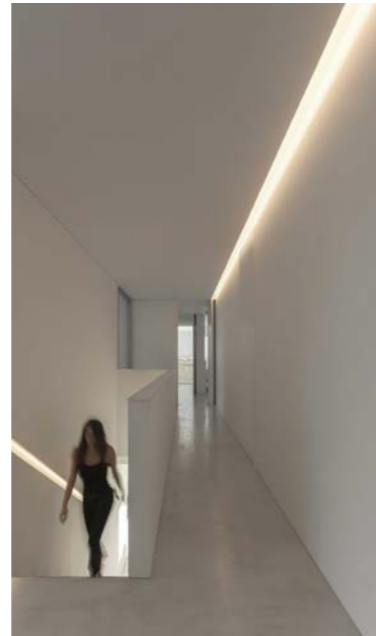

Technical Details

| Power | 4.8W/M 1.46W/ft | Lumens | | | ErP Class |
|-------------------------|---------------------------|---------|----------|----------|-----------|
| Voltage | DC24V | ● 2700K | 950lm/m | 290lm/ft | B |
| RA | 80 | ● 3000K | 990lm/m | 302lm/ft | B |
| Led Qty | 90LEDs/M 27LEDs/ft | ● 4000K | 1035lm/m | 316lm/ft | B |
| Length/Reel | 5004mm 16.41ft | ● 5000K | 1025lm/m | 313lm/ft | B |
| Cutting Length | 100mm 3.93" | ● 6000K | 1025lm/m | 313lm/ft | B |
| Waterproof grade | IP20 / IP62 / IP65 / IP68 | | | | |

Note: 'x' (CCT) = "27"(2700K) / "30"(3000K) / "40"(4000K) / "50"(5000K) / "60"(6000K), Please contact us for more information.

* Please contact our sales for the latest details and certifications

Dimension

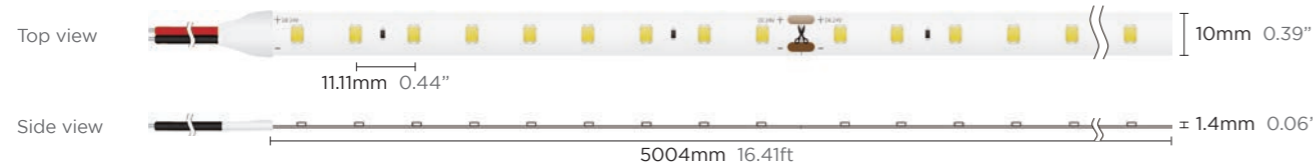

Connectors List

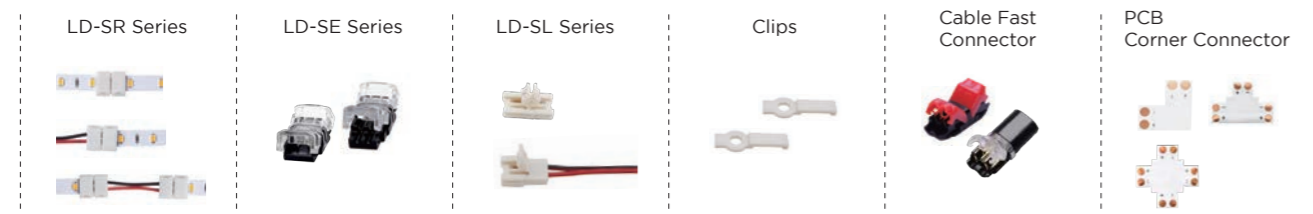

* Please Go to page 248 for Accessory and Connector Usage Guidelines.

LED STRIP SERIES · ERP SERIES

200-215LM/W RA80

180LEDs/M 9.6W

Product NO. AUERP09WW-24VCLM-200LM180L

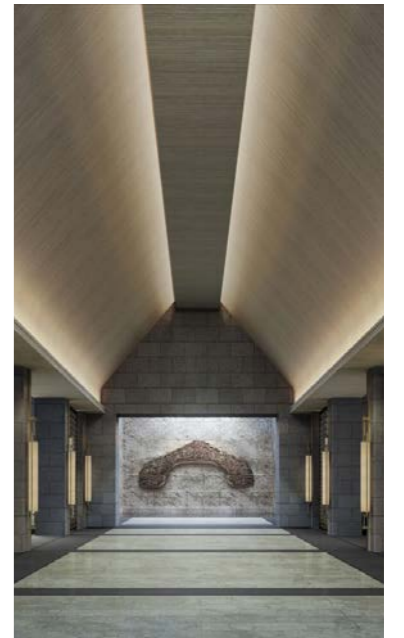

Technical Details

| Power | 9.6W/M 2.92W/ft | Lumens | | | ErP Class |
|-------------------------|---------------------------|---------|----------|----------|-----------|
| Voltage | DC24V | ● 2700K | 1920lm/m | 585lm/ft | B |
| RA | 80 | ● 3000K | 1985lm/m | 605lm/ft | B |
| Led Qty | 180LEDs/M 54LEDs/ft | ● 4000K | 2100lm/m | 640lm/ft | B |
| Length/Reel | 5004mm 16.41ft | ● 5000K | 2035lm/m | 620lm/ft | B |
| Cutting Length | 50mm 1.97" | ● 6000K | 2070lm/m | 631lm/ft | B |
| Waterproof grade | IP20 / IP62 / IP65 / IP68 | | | | |

Note: 'x' (CCT) = "27"(2700K) / "30"(3000K) / "40"(4000K) / "50"(5000K) / "60"(6000K), Please contact us for more information.

* Please contact our sales for the latest details and certifications

Dimension



Connectors List



* Please Go to page 248 for Accessory and Connector Usage Guidelines.

LED STRIP SERIES · ERP SERIES

110-120LM/W CRI90

70LEDs/M 4.8W

Product NO. AUERP04WW-24VCLM-110LM70L-C90



Technical Details

| Power | 4.8W/M 1.46W/ft | Lumens | | ErP Class | | | | | | | | |
|-------------------------|---------------------------|---------|------------------|-----------|------------------|---------|------------------|---------|------------------|---------|------------------|---|
| Voltage | DC24V | ● 2700K | 530lm/m 162lm/ft | ● 3000K | 560lm/m 171lm/ft | ● 4000K | 600lm/m 183lm/ft | ● 5000K | 575lm/m 175lm/ft | ● 6000K | 580lm/m 177lm/ft | F |
| CRI | 90 | F | F | F | F | F | F | F | F | F | F | F |
| Led Qty | 70LEDs/M 21LEDs/ft | | | | | | | | | | | |
| Length/Reel | 5004mm 16.41ft | | | | | | | | | | | |
| Cutting Length | 100mm 3.93" | | | | | | | | | | | |
| Waterproof grade | IP20 / IP62 / IP65 / IP68 | | | | | | | | | | | |

Note: 'x' (CCT) = "27"(2700K) / "30"(3000K) / "40"(4000K) / "50"(5000K) / "60"(6000K), Please contact us for more information.

* Please contact our sales for the latest details and certifications

Dimension

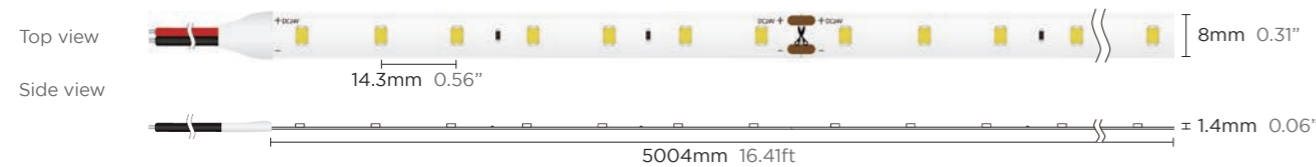

Connectors List

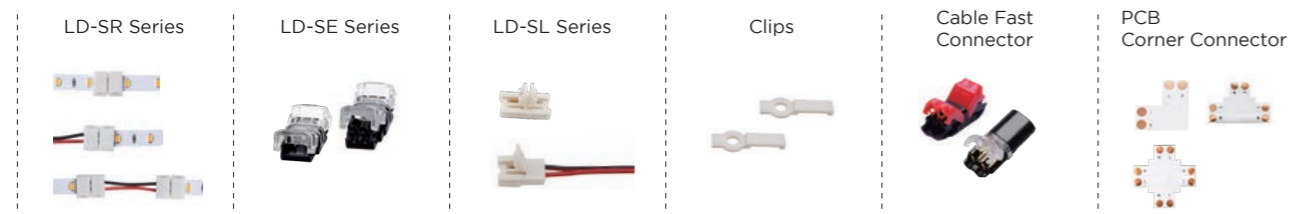

* Please Go to page 248 for Accessory and Connector Usage Guidelines.

LED STRIP SERIES · ERP SERIES

110-120LM/W CRI90

140LEDs/M 9.6W

Product NO. AUERP09WW-24VCLM-110LM140L-C90

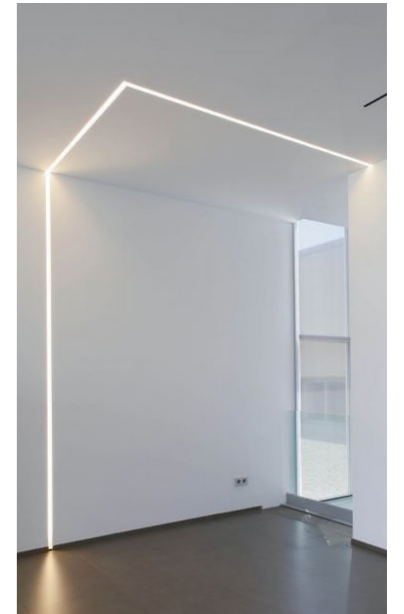

Technical Details

| Power | 9.6W/M 2.93W/ft | Lumens | | ErP Class | | | | | | | | |
|-------------------------|---------------------------|---------|-------------------|-----------|-------------------|---------|-------------------|---------|-------------------|---------|-------------------|---|
| Voltage | DC24V | ● 2700K | 1055lm/m 322lm/ft | ● 3000K | 1105lm/m 337lm/ft | ● 4000K | 1185lm/m 361lm/ft | ● 5000K | 1085lm/m 331lm/ft | ● 6000K | 1115lm/m 340lm/ft | F |
| CRI | 90 | F | F | F | F | F | F | F | F | F | F | F |
| Led Qty | 140LEDs/M 42LEDs/ft | | | | | | | | | | | |
| Length/Reel | 5004mm 16.41ft | | | | | | | | | | | |
| Cutting Length | 50mm 1.97" | | | | | | | | | | | |
| Waterproof grade | IP20 / IP62 / IP65 / IP68 | | | | | | | | | | | |

Note: 'x' (CCT) = "27"(2700K) / "30"(3000K) / "40"(4000K) / "50"(5000K) / "60"(6000K), Please contact us for more information.

* Please contact our sales for the latest details and certifications

Dimension

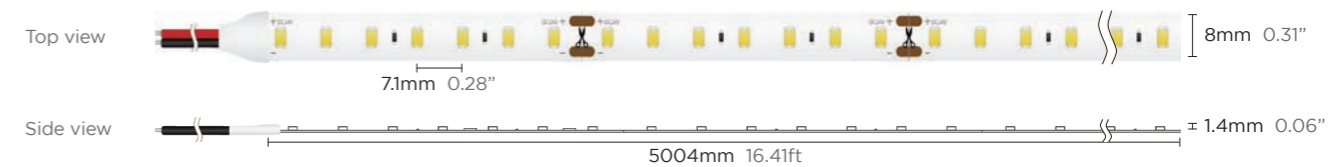

Connectors List



* Please Go to page 248 for Accessory and Connector Usage Guidelines.

LED STRIP SERIES · ERP SERIES

110-120LM/W CRI90

210LEDs/M 14.4W

Product NO. AUERP14WW-24VCLM-110LM210L-C90



Technical Details

| Power | 14.4W/M 4.39W/ft | Lumens | | ErP Class |
|-------------------------|---------------------------|---------|-------------------|-----------|
| Voltage | DC24V | ● 2700K | 1655lm/m 505lm/ft | F |
| CRI | 90 | ● 3000K | 1700lm/m 518lm/ft | F |
| Led Qty | 210LEDs/M 64LEDs/ft | ● 4000K | 1845lm/m 563lm/ft | F |
| Length/Reel | 5004mm 16.41ft | ● 5000K | 1845lm/m 563lm/ft | F |
| Cutting Length | 33.3mm 1.31" | ● 6000K | 1730lm/m 527lm/ft | F |
| Waterproof grade | IP20 / IP62 / IP65 / IP68 | | | |

Note: 'x' (CCT) = "27"(2700K) / "30"(3000K) / "40"(4000K) / "50"(5000K) / "60"(6000K), Please contact us for more information.

* Please contact our sales for the latest details and certifications

Dimension

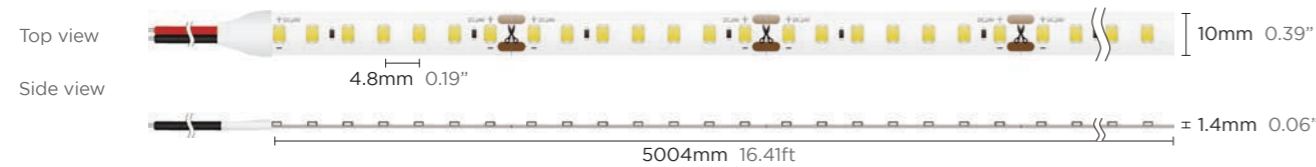

Connectors List

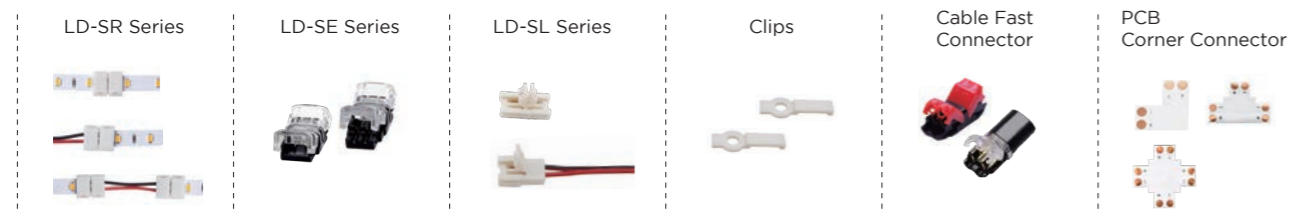

* Please Go to page 248 for Accessory and Connector Usage Guidelines.

110-120LM/W CRI90

252LEDs/M 19.2W

Product NO. AUERP19WW-24VCLM-110LM252L-C90



Technical Details

| Power | 19.2W/M 5.85W/ft | Lumens | | ErP Class |
|-------------------------|---------------------------|---------|-------------------|-----------|
| Voltage | DC24V | ● 2700K | 2215lm/m 675lm/ft | F |
| CRI | 90 | ● 3000K | 2265lm/m 691lm/ft | F |
| Led Qty | 252LEDs/M 76LEDs/ft | ● 4000K | 2300lm/m 701lm/ft | F |
| Length/Reel | 5004mm 16.41ft | ● 5000K | 2300lm/m 701lm/ft | F |
| Cutting Length | 27.8mm 1.09" | ● 6000K | 2300lm/m 701lm/ft | F |
| Waterproof grade | IP20 / IP62 / IP65 / IP68 | | | |

Note: 'x' (CCT) = "27"(2700K) / "30"(3000K) / "40"(4000K) / "50"(5000K) / "60"(6000K), Please contact us for more information.

* Please contact our sales for the latest details and certifications

Dimension

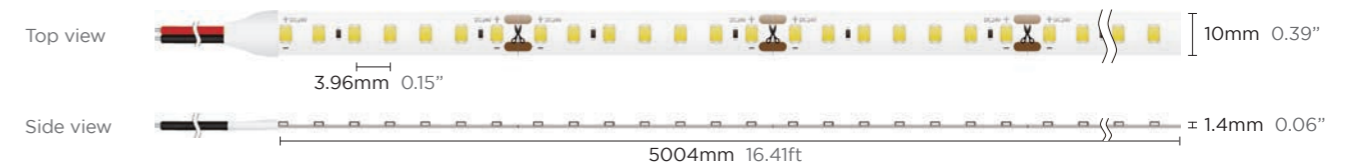

Connectors List



* Please Go to page 248 for Accessory and Connector Usage Guidelines.

125-140LM/W CRI90

64LEDs/M 4.8W

Product NO. AUERP04WW-24VCLM-125LM64L-C90



Technical Details

| Power | 4.8W/M 1.46W/ft | Lumens | | | ErP Class |
|-------------------------|---------------------------|---------|---------|----------|-----------|
| Voltage | DC24V | ● 2700K | 615lm/m | 188lm/ft | E |
| CRI | 90 | ● 3000K | 625lm/m | 191lm/ft | E |
| Led Qty | 64LEDs/M 19LEDs/ft | ● 4000K | 660lm/m | 201lm/ft | E |
| Length/Reel | 5004mm 16.41ft | ● 5000K | 660lm/m | 201lm/ft | E |
| Cutting Length | 125mm 4.92" | ● 6000K | 660lm/m | 201lm/ft | E |
| Waterproof grade | IP20 / IP62 / IP65 / IP68 | | | | |

Note:'x' (CCT) = "27"(2700K) / "30"(3000K) / "40"(4000K) / "50"(5000K) / "60"(6000K), Please contact us for more information.

* Please contact our sales for the latest details and certifications

Dimension

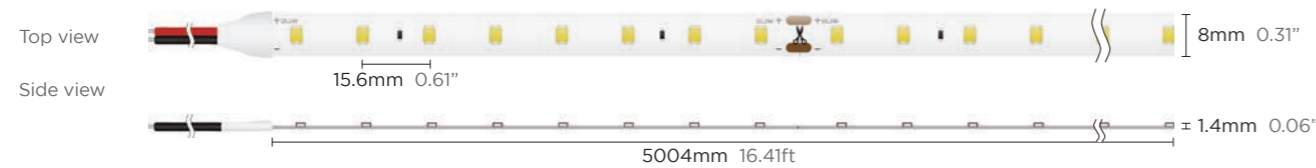

Connectors List

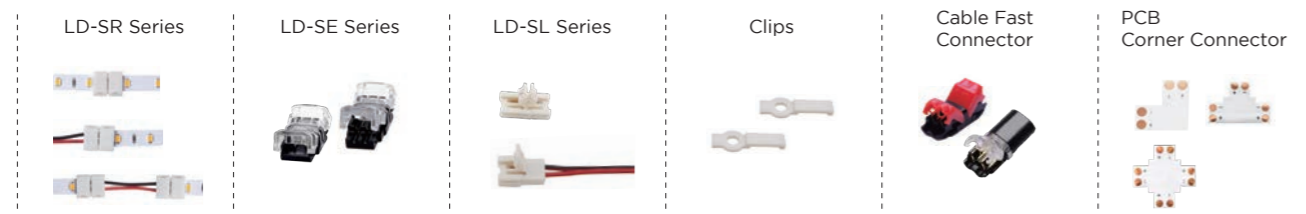

* Please Go to page 248 for Accessory and Connector Usage Guidelines.

LED STRIP SERIES · ERP SERIES

125-140LM/W CRI90

80LEDs/M 9.6W

Product NO. AUERP09WW-24VCLM-125LM80L-C90

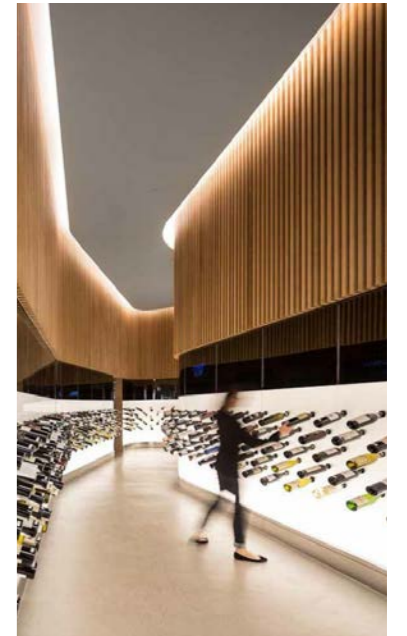

Technical Details

| Power | 9.6W/M 2.93W/ft | Lumens | | | ErP Class |
|-------------------------|---------------------------|---------|----------|----------|-----------|
| Voltage | DC24V | ● 2700K | 1230lm/m | 375lm/ft | E |
| CRI | 90 | ● 3000K | 1250lm/m | 381lm/ft | E |
| Led Qty | 80LEDs/M 24LEDs/ft | ● 4000K | 1295lm/m | 395lm/ft | E |
| Length/Reel | 5004mm 16.41ft | ● 5000K | 1295lm/m | 395lm/ft | E |
| Cutting Length | 100mm 3.93" | ● 6000K | 1295lm/m | 395lm/ft | E |
| Waterproof grade | IP20 / IP62 / IP65 / IP68 | | | | |

Note:'x' (CCT) = "27"(2700K) / "30"(3000K) / "40"(4000K) / "50"(5000K) / "60"(6000K), Please contact us for more information.

* Please contact our sales for the latest details and certifications

Dimension



Connectors List



* Please Go to page 248 for Accessory and Connector Usage Guidelines.

LED STRIP SERIES · ERP SERIES

125-140LM/W CRI90

128LEDs/M 9.6W

Product NO. AUERP09WW-24VCLM-125LM128L-C90



Technical Details

| Power | 9.6W/M 2.93W/ft | Lumens | | | ErP Class |
|-------------------------|---------------------------|---------|----------|----------|-----------|
| Voltage | DC24V | ● 2700K | 1250lm/m | 381lm/ft | E |
| CRI | 90 | ● 3000K | 1270lm/m | 387lm/ft | E |
| Led Qty | 128LEDs/M 39LEDs/ft | ● 4000K | 1325lm/m | 404lm/ft | E |
| Length/Reel | 5004mm 16.41ft | ● 5000K | 1325lm/m | 404lm/ft | E |
| Cutting Length | 62.5mm 2.46" | ● 6000K | 1325lm/m | 404lm/ft | E |
| Waterproof grade | IP20 / IP62 / IP65 / IP68 | | | | |

Note: 'x' (CCT) = "27"(2700K) / "30"(3000K) / "40"(4000K) / "50"(5000K) / "60"(6000K), Please contact us for more information.

* Please contact our sales for the latest details and certifications

Dimension

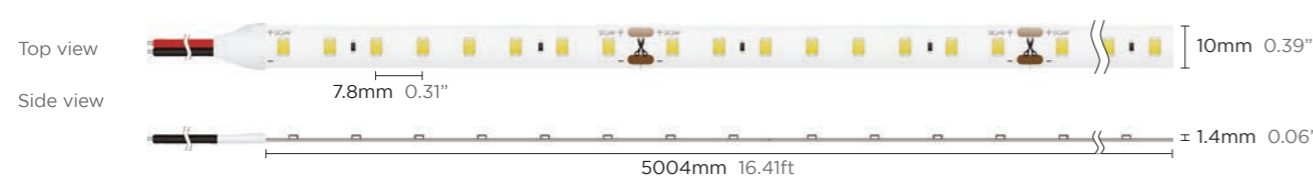

Connectors List

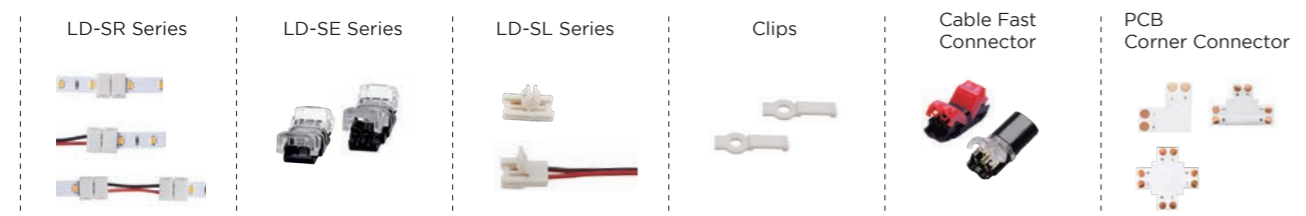

* Please Go to page 248 for Accessory and Connector Usage Guidelines.

LED STRIP SERIES · ERP SERIES

125-140LM/W CRI90

160LEDs/M 14.4W

Product NO. AUERP14WW-24VCLM-125LM160L-C90

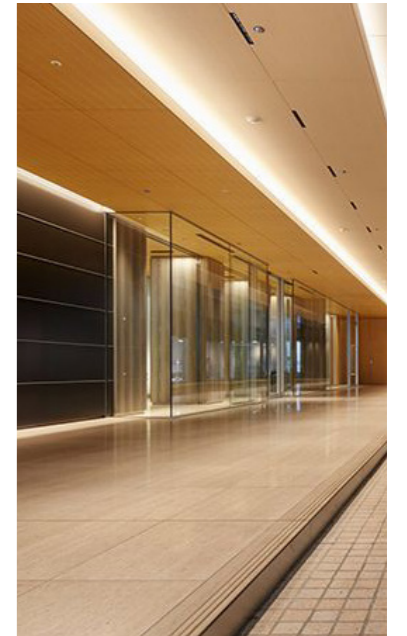

Technical Details

| Power | 14.4W/M 4.39W/ft | Lumens | | | ErP Class |
|-------------------------|---------------------------|---------|----------|----------|-----------|
| Voltage | DC24V | ● 2700K | 1845lm/m | 563lm/ft | E |
| CRI | 90 | ● 3000K | 1870lm/m | 570lm/ft | E |
| Led Qty | 160LEDs/M 48LEDs/ft | ● 4000K | 1945lm/m | 593lm/ft | E |
| Length/Reel | 5004mm 16.41ft | ● 5000K | 1945lm/m | 593lm/ft | E |
| Cutting Length | 50mm 1.96" | ● 6000K | 1945lm/m | 593lm/ft | E |
| Waterproof grade | IP20 / IP62 / IP65 / IP68 | | | | |

Note: 'x' (CCT) = "27"(2700K) / "30"(3000K) / "40"(4000K) / "50"(5000K) / "60"(6000K), Please contact us for more information.

* Please contact our sales for the latest details and certifications

Dimension

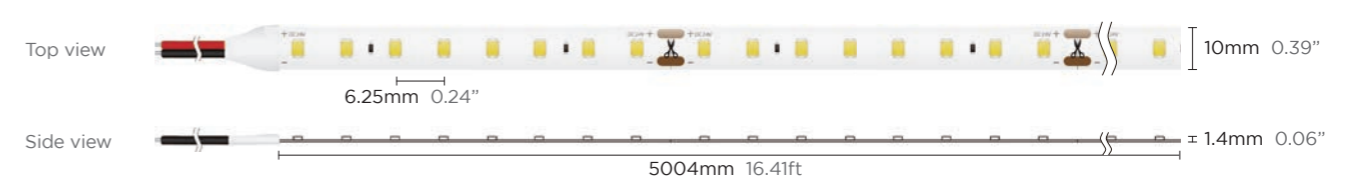

Connectors List



* Please Go to page 248 for Accessory and Connector Usage Guidelines.

LED STRIP SERIES · ERP SERIES

140-165LM/W RA90

64LEDs/M 4.8W

Product NO. AUERP04WW-24VCLM-140LM64L-R90



Technical Details

| Power | 4.8W/M 1.46W/ft | Lumens | | | ErP Class |
|-------------------------|---------------------------|---------|---------|----------|-----------|
| Voltage | DC24V | ● 2700K | 700lm/m | 213lm/ft | E |
| RA | 90 | ● 3000K | 725lm/m | 221lm/ft | D |
| Led Qty | 64LEDs/M 19LEDs/ft | ● 4000K | 810lm/m | 247lm/ft | D |
| Length/Reel | 5004mm 16.41ft | ● 5000K | 770lm/m | 235lm/ft | D |
| Cutting Length | 125mm 4.92" | ● 6000K | 770lm/m | 235lm/ft | D |
| Waterproof grade | IP20 / IP62 / IP65 / IP68 | | | | |

Note: 'x' (CCT) = "27"(2700K) / "30"(3000K) / "40"(4000K) / "50"(5000K) / "60"(6000K), Please contact us for more information.

* Please contact our sales for the latest details and certifications

Dimension

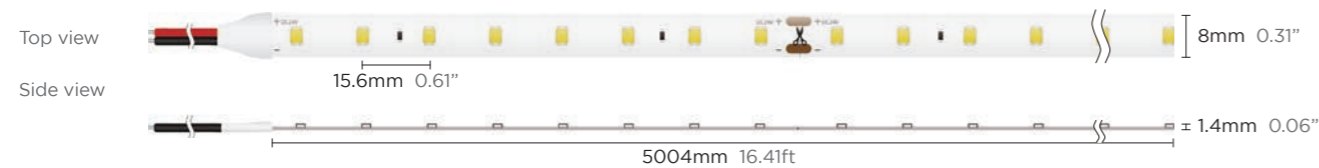

Connectors List



* Please Go to page 248 for Accessory and Connector Usage Guidelines.

140-165LM/W RA90

80LEDs/M 9.6W

Product NO. AUERP09WW-24VCLM-140LM80L-R90

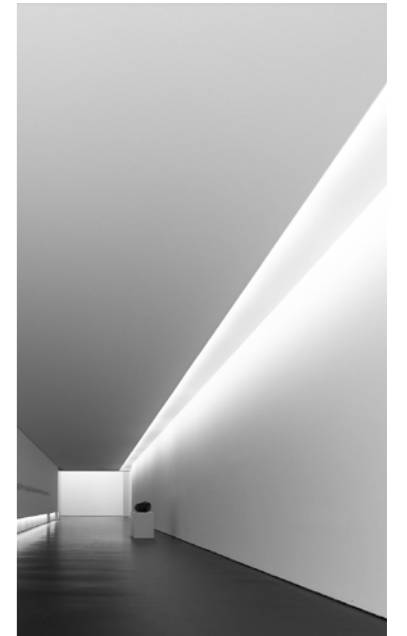

Technical Details

| Power | 9.6W/M 2.93W/ft | Lumens | | | ErP Class |
|-------------------------|---------------------------|---------|----------|----------|-----------|
| Voltage | DC24V | ● 2700K | 1360lm/m | 415lm/ft | E |
| RA | 90 | ● 3000K | 1445lm/m | 441lm/ft | D |
| Led Qty | 80LEDs/M 24LEDs/ft | ● 4000K | 1585lm/m | 483lm/ft | D |
| Length/Reel | 5004mm 16.41ft | ● 5000K | 1475lm/m | 450lm/ft | D |
| Cutting Length | 100mm 3.93" | ● 6000K | 1525lm/m | 465lm/ft | D |
| Waterproof grade | IP20 / IP62 / IP65 / IP68 | | | | |

Note: 'x' (CCT) = "27"(2700K) / "30"(3000K) / "40"(4000K) / "50"(5000K) / "60"(6000K), Please contact us for more information.

* Please contact our sales for the latest details and certifications

Dimension



Connectors List



* Please Go to page 248 for Accessory and Connector Usage Guidelines.

140-165LM/W RA90

128LEDs/M 14.4W

Product NO. AUERP14WW-24VCLM-140LM128L-R90



Technical Details

| Power | 14.4W/M 4.39W/ft | Lumens | | ErP Class | |
|------------------|---------------------------|---------|-------------------|-----------|--|
| Voltage | DC24V | ● 2700K | 2085lm/m 636lm/ft | ● E | |
| RA | 90 | ● 3000K | 2160lm/m 659lm/ft | ● D | |
| Led Qty | 128LEDs/M 39LEDs/ft | ● 4000K | 2430lm/m 741lm/ft | ● D | |
| Length/Reel | 5004mm 16.41ft | ● 5000K | 2245lm/m 684lm/ft | ● D | |
| Cutting Length | 62.5mm 2.46" | ● 6000K | 2260lm/m 689lm/ft | ● D | |
| Waterproof grade | IP20 / IP62 / IP65 / IP68 | | | | |

Note:'x' (CCT) = "27"(2700K) / "30"(3000K) / "40"(4000K) / "50"(5000K) / "60"(6000K), Please contact us for more information.

* Please contact our sales for the latest details and certifications

Dimension

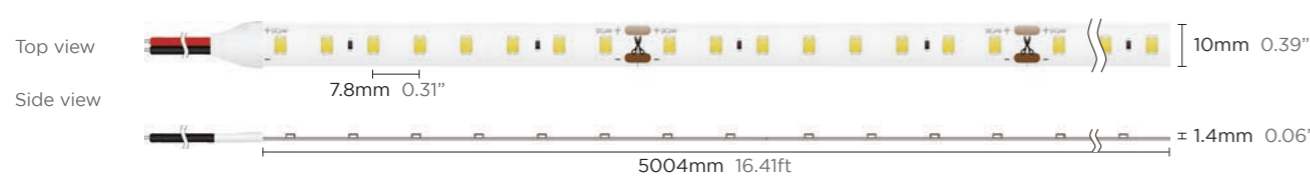

Connectors List

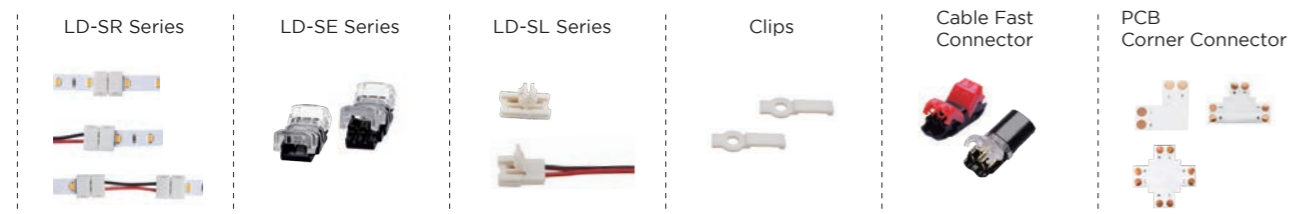

* Please Go to page 248 for Accessory and Connector Usage Guidelines.

140-165LM/W RA90

160LEDs/M 19.2W

Product NO. AUERP19WW-24VCLM-140LM160L-R90

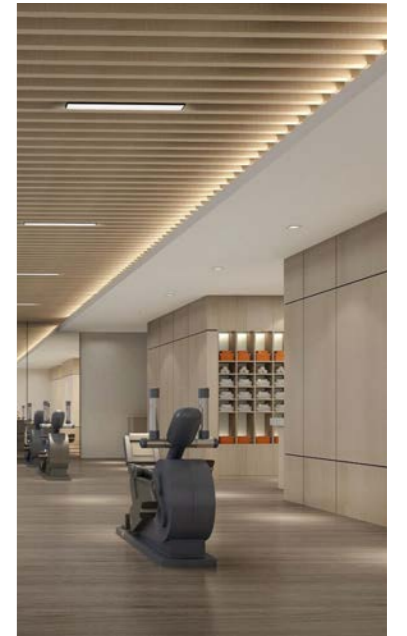

Technical Details

| Power | 19.2W/M 5.85W/ft | Lumens | | ErP Class | |
|------------------|---------------------------|---------|-------------------|-----------|--|
| Voltage | DC24V | ● 2700K | 2725lm/m 831lm/ft | ● E | |
| RA | 90 | ● 3000K | 2895lm/m 883lm/ft | ● D | |
| Led Qty | 160LEDs/M 48LEDs/ft | ● 4000K | 3185lm/m 971lm/ft | ● D | |
| Length/Reel | 5004mm 16.41ft | ● 5000K | 2975lm/m 907lm/ft | ● D | |
| Cutting Length | 50mm 1.96" | ● 6000K | 3010lm/m 918lm/ft | ● D | |
| Waterproof grade | IP20 / IP62 / IP65 / IP68 | | | | |

Note:'x' (CCT) = "27"(2700K) / "30"(3000K) / "40"(4000K) / "50"(5000K) / "60"(6000K), Please contact us for more information.

* Please contact our sales for the latest details and certifications

Dimension



Connectors List



* Please Go to page 248 for Accessory and Connector Usage Guidelines.

170-195LM/W RA90

90LEDs/M 4.8W

Product NO. AUERP04WW-24VCLM-170LM90L-R90



Technical Details

| Power | 4.8W/M 1.46W/ft | Lumens | | ErP Class | |
|------------------|---------------------------|---------|------------------|-----------|----------|
| Voltage | DC24V | ● 2700K | 825lm/m 252lm/ft | | E |
| RA | 90 | ● 3000K | 840lm/m 256lm/ft | | D |
| Led Qty | 90LEDs/M 27LEDs/ft | ● 4000K | 930lm/m 284lm/ft | | D |
| Length/Reel | 5004mm 16.41ft | ● 5000K | 930lm/m 284lm/ft | | D |
| Cutting Length | 100mm 3.93" | ● 6000K | 930lm/m 284lm/ft | | D |
| Waterproof grade | IP20 / IP62 / IP65 / IP68 | | | | |

Note: 'x' (CCT) = "27"(2700K) / "30"(3000K) / "40"(4000K) / "50"(5000K) / "60"(6000K), Please contact us for more information.

* Please contact our sales for the latest details and certifications

Dimension

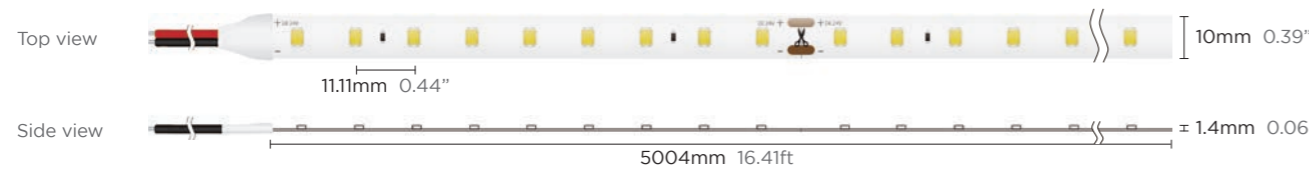

Connectors List

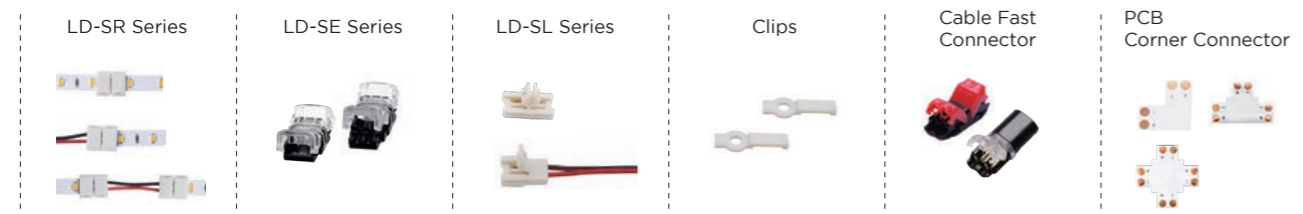

* Please Go to page 248 for Accessory and Connector Usage Guidelines.

170-195LM/W RA90

180LEDs/M 9.6W

Product NO. AUERP09WW-24VCLM-170LM180L-R90



Technical Details

| Power | 9.6W/M 2.92W/ft | Lumens | | ErP Class | |
|------------------|---------------------------|---------|-------------------|-----------|----------|
| Voltage | DC24V | ● 2700K | 1660lm/m 506lm/ft | | E |
| RA | 90 | ● 3000K | 1670lm/m 509lm/ft | | D |
| Led Qty | 180LEDs/M 54LEDs/ft | ● 4000K | 1830lm/m 558lm/ft | | D |
| Length/Reel | 5004mm 16.41ft | ● 5000K | 1830lm/m 558lm/ft | | D |
| Cutting Length | 50mm 1.97" | ● 6000K | 1830lm/m 558lm/ft | | D |
| Waterproof grade | IP20 / IP62 / IP65 / IP68 | | | | |

Note: 'x' (CCT) = "27"(2700K) / "30"(3000K) / "40"(4000K) / "50"(5000K) / "60"(6000K), Please contact us for more information.

* Please contact our sales for the latest details and certifications

Dimension

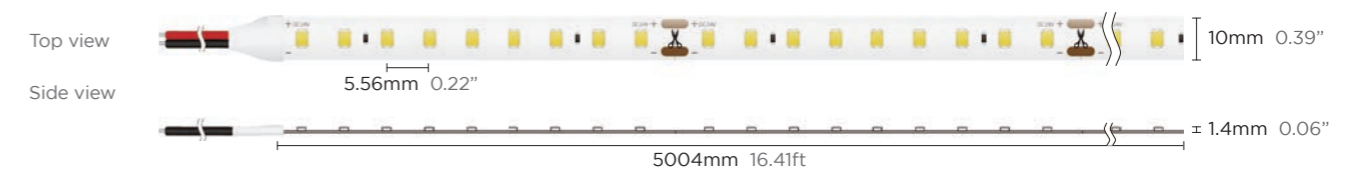

Connectors List



* Please Go to page 248 for Accessory and Connector Usage Guidelines.

Spotless Lighting Series



Cutting free



Beam angle 180°



Higher efficiency



Dots-free





Beam angle 180°.
High efficacy 2216 Plus LED inside, Uniform luminescence, Spotless.
Bendable at horizontal direction.
Extrusion process, 3M tape, Easy installation.

8x4.5mm 12W

Extrusion process



| | Cutting Free | Mini Cutting |
|------------------|--------------------------|--------------------------|
| Product NO. | AUEP084512WW-24VCLM-300L | AUEP084512WW-24VCLM-288L |
| Voltage | DC24V | DC24V |
| Power | 12W/M 3.66W/ft | 12W/M 3.66W/ft |
| CRI | 90 | 90 |
| Led Qty | 300LEDs/M 91LEDs/ft | 288LEDs/M 88LEDs/ft |
| Cutting Length | Cutting Free | 27.77mm 1.09" |
| Waterproof grade | IP62 | IP62 |
| Length/Reel | 5050mm 16.56ft | 5050mm 16.56ft |
| Lumens | | |
| ● 2700K | 885lm/m 270lm/ft | 1295lm/m 395lm/ft |
| ● 3000K | 935lm/m 285lm/ft | 1345lm/m 410lm/ft |
| ● 4000K | 970lm/m 296lm/ft | 1380lm/m 421lm/ft |
| ○ 6000K | 970lm/m 296lm/ft | 1380lm/m 421lm/ft |

Note:'x' (CCT) = "27"(2700K) / "30"(3000K) / "40"(4000K) / "50"(5000K) / "60"(6000K). Please contact us for more information.

Dimension

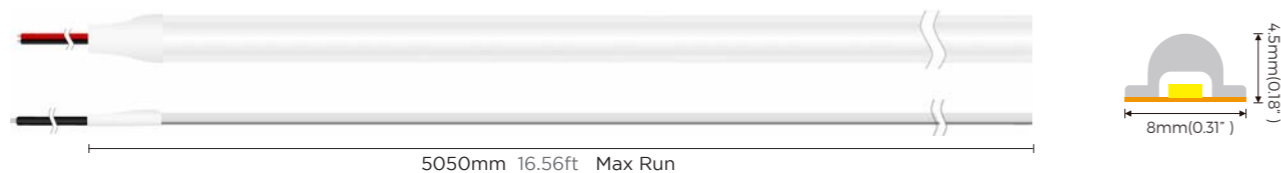

Beam angle 180°.
High efficacy 2216 Plus LED inside, Uniform luminescence, Spotless.
Bendable at horizontal direction.
Extrusion process, 3M tape, true outdoor application.

10x4.5mm 12W

Extrusion process



| | Cutting Free | Mini Cutting |
|------------------|--------------------------|--------------------------|
| Product NO. | AUEP104512WW-24VCLM-300L | AUEP104512WW-24VCLM-288L |
| Voltage | DC24V | DC24V |
| Power | 12W/M 3.66W/ft | 12W/M 3.66W/ft |
| CRI | 90 | 90 |
| Led Qty | 300LEDs/M 91LEDs/ft | 288LEDs/M 88LEDs/ft |
| Cutting Length | Cutting Free | 27.77mm 1.09" |
| Waterproof grade | IP67 | IP67 |
| Length/Reel | 5050mm 16.56ft | 5050mm 16.56ft |
| Lumens | | |
| ● 2700K | 815lm/m 248lm/ft | 1220lm/m 372lm/ft |
| ● 3000K | 850lm/m 259lm/ft | 1260lm/m 384lm/ft |
| ● 4000K | 910lm/m 277lm/ft | 1295lm/m 395lm/ft |
| ○ 6000K | 910lm/m 277lm/ft | 1295lm/m 395lm/ft |

Note:'x' (CCT) = "27"(2700K) / "30"(3000K) / "40"(4000K) / "50"(5000K) / "60"(6000K). Please contact us for more information.

Dimension

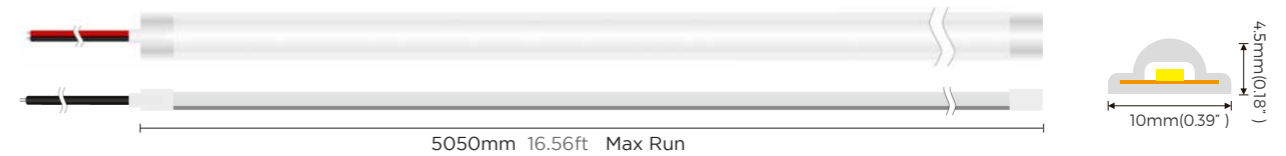



Beam angle 180°.
 High efficacy 2216 Plus LED inside, Uniform luminescence, Spotless.
 Bendable at horizontal direction.
 Tri-color extrusion process, 3M tape, true outdoor application.

10x5mm 12W

Tri-color extrusion process



Cutting Free

Mini Cutting

| Product NO. | AUEP100512WW-24VCLM-300L | AUEP100512WW-24VCLM-288L |
|------------------|--------------------------|--------------------------|
| Voltage | DC24V | DC24V |
| Power | 12W/M 3.66W/ft | 12W/M 3.66W/ft |
| CRI | 90 | 90 |
| Led Qty | 300LEDs/M 91LEDs/ft | 288LEDs/M 88LEDs/ft |
| Cutting Length | Cutting Free | 27.77mm 1.09" |
| Waterproof grade | IP67 | IP67 |
| Length/Reel | 5050mm 16.56ft | 5050mm 16.56ft |
| Lumens | | |
| ● 2700K | 780lm/m 238lm/ft | 1210lm/m 369lm/ft |
| ● 3000K | 825lm/m 252lm/ft | 1245lm/m 380lm/ft |
| ● 4000K | 885lm/m 270lm/ft | 1280lm/m 390lm/ft |
| ○ 6000K | 885lm/m 270lm/ft | 1280lm/m 390lm/ft |

Note: 'x' (CCT) = "27"(2700K) / "30"(3000K) / "40"(4000K) / "50"(5000K) / "60"(6000K). Please contact us for more information.

Dimension

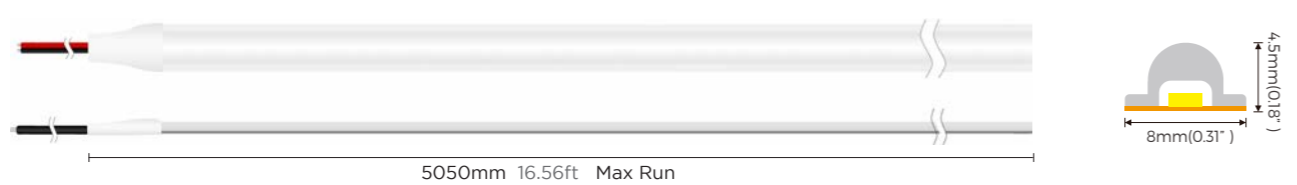

10x5mm-IP67
 Tri-color extrusion process

10x4.5mm-IP67
 Extrusion process

8x4.5mm-IP62
 Extrusion process

LED STRIP SERIES · SPOTLESS LIGHTING

Spotless Lighting Series

Diffuse design, lights soft, COB PCB.



2700K 3000K 4000K 5000K 6000K

10x4mm White 10W



| | | |
|------------------|--------------------------|--------------------------|
| Product NO. | AUSL100410WW-24VCLM-480L | Lumens |
| Voltage | DC24V | ● 2700K 750lm/m 229lm/ft |
| Power | 10W/M 3.04W/ft | ● 3000K 780lm/m 238lm/ft |
| CRI | 90 | ● 4000K 860lm/m 262lm/ft |
| Led Qty | 480LEDs/M 146LEDs/ft | ○ 6000K 860lm/m 262lm/ft |
| Cutting Length | 50mm 1.97" | |
| Waterproof grade | IP67 | |
| Length/Reel | 5050mm 16.56ft | |

Note: 'x' (CCT) = "27"(2700K) / "30"(3000K) / "40"(4000K) / "50"(5000K) / "60"(6000K), Please contact us for more information.

Dimension

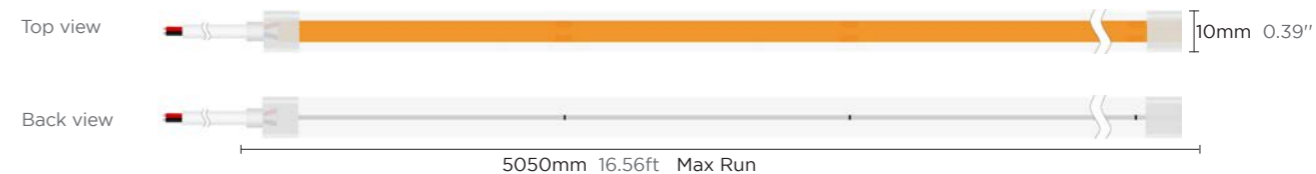

Accessories



※ Please contact our sales for the latest details and certifications

Spotless Lighting / Blue



10x4mm 10W



| | | |
|------------------|--------------------------|------------------------|
| Product NO. | AUSL100410WB-24VCLM-480L | Lumens |
| Voltage | DC24V | ● Blue 109lm/m 33lm/ft |
| Power | 10W/M 3.04W/ft | |
| CRI | 90 | |
| Led Qty | 480LEDs/M 146LEDs/ft | |
| Cutting Length | 50mm 1.97" | |
| Waterproof grade | IP67 | |
| Length/Reel | 5050mm 16.56ft | |

Note: 'x' (CCT) = "27"(2700K) / "30"(3000K) / "40"(4000K) / "50"(5000K) / "60"(6000K), Please contact us for more information.

Dimension

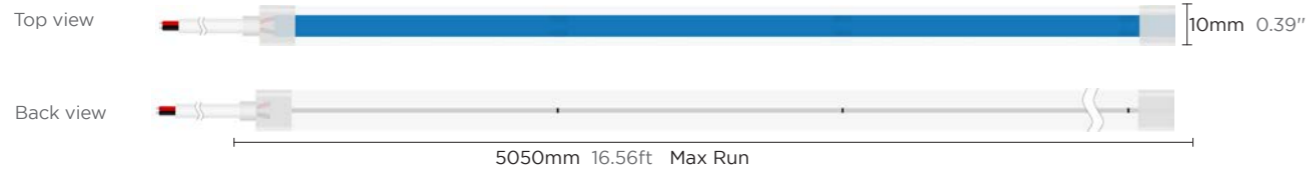

Accessories



* Please contact our sales for the latest details and certifications

LED STRIP SERIES · SPOTLESS LIGHTING

Spotless Lighting / Red



10x4mm 10W



| | | |
|------------------|--------------------------|-----------------------|
| Product NO. | AUSL100410WR-24VCLM-480L | Lumens |
| Voltage | DC24V | ● Red 104lm/m 32lm/ft |
| Power | 10W/M 3.04W/ft | |
| CRI | 90 | |
| Led Qty | 480LEDs/M 146LEDs/ft | |
| Cutting Length | 50mm 1.97" | |
| Waterproof grade | IP67 | |
| Length/Reel | 5050mm 16.56ft | |

Note: 'x' (CCT) = "27"(2700K) / "30"(3000K) / "40"(4000K) / "50"(5000K) / "60"(6000K), Please contact us for more information.

Dimension

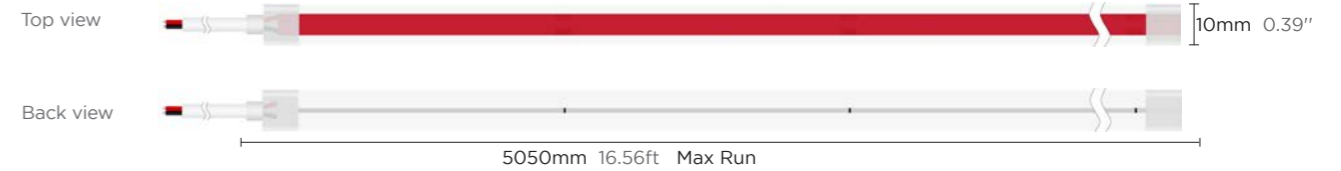

Accessories



* Please contact our sales for the latest details and certifications

LED STRIP SERIES · SPOTLESS LIGHTING

2835 Reel to Reel Series

No soldering joints, No risk of false soldering and weak soldering, easy to cut.
50m/reel,100m/reel in package are available.
Accurate size without deviation.

LED STRIP SERIES · ROLL TO ROLL SERIES

LED STRIP SERIES · ROLL TO ROLL SERIES



2835 Reel to Reel Series

60LEDs / 5M 10M

More stable as no soldering joints
 High efficacy up to 95lm/W
 High CRI 90,SDCM 3 available



LED STRIP SERIES · 2835 REEL TO REEL SERIES

More stable without soldering joints.



60LEDs/5M

Product NO.
 AURR283504WW-24VCLM-5M

Technical Details

| | |
|-------------------------|--------------------|
| Power | 4.8W/M 1.46W/ft |
| Voltage | DC24V |
| CRI | 90 |
| Led Qty | 60LEDs/M 18LEDs/ft |
| Length/Reel | 5M 16.41ft |
| Cutting Length | 100mm 3.93" |
| PCB | 8mm 0.31" |
| Waterproof grade | IP20 |

| Lumens | | | ErP Class |
|---------|---------|----------|-----------|
| ● 2700K | 425lm/m | 130lm/ft | G |
| ● 3000K | 450lm/m | 137lm/ft | F |
| ● 4000K | 460lm/m | 140lm/ft | F |
| ● 5000K | 460lm/m | 140lm/ft | F |
| ● 6500K | 460lm/m | 140lm/ft | F |

Note: 'x' (CCT) = "27"(2700K) / "30"(3000K) / "40"(4000K) / "50"(5000K) / "60"(6000K), Please contact us for more information.
 * Please contact our sales for the latest details and certifications

60LEDs/10M

Product NO.
 AURR283504WW-24VCLM-10M

Technical Details

| | |
|-------------------------|--------------------|
| Power | 4.8W/M 1.46W/ft |
| Voltage | DC24V |
| CRI | 90 |
| Led Qty | 60LEDs/M 18LEDs/ft |
| Length/Reel | 10M 32.8ft |
| Cutting Length | 100mm 3.93" |
| PCB | 8mm 0.31" |
| Waterproof grade | IP20 |

| Lumens | | | ErP Class |
|---------|---------|----------|-----------|
| ● 2700K | 425lm/m | 130lm/ft | G |
| ● 3000K | 450lm/m | 137lm/ft | F |
| ● 4000K | 460lm/m | 140lm/ft | F |
| ● 5000K | 460lm/m | 140lm/ft | F |
| ● 6500K | 460lm/m | 140lm/ft | F |

Dimension

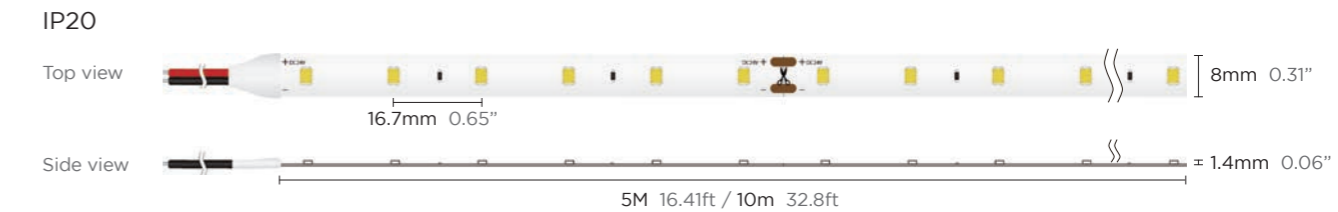

Connectors List



* Please Go to page 248 for Accessory and Connector Usage Guidelines.

LED STRIP SERIES · 2835 REEL TO REEL SERIES

2835 Reel to Reel Series

120LEDs / 5M 10M

More stable as no soldering joints
High efficacy, up to 95lm/W
High CRI 90, SDCM<3 available



More stable without soldering joints.



120LEDs/5M

Product NO.
AURR283509WW-24VCLM-5M

Technical Details

| | |
|-------------------------|---------------------|
| Power | 9.6W/M 2.93W/ft |
| Voltage | DC24V |
| CRI | 90 |
| Led Qty | 120LEDs/M 36LEDs/ft |
| Length/Reel | 5M 16.41ft |
| Cutting Length | 50mm 1.97" |
| PCB | 8mm 0.31" |
| Waterproof grade | IP20 |

| Lumens | | | ErP Class |
|---------|------------------|--|-----------|
| ● 2700K | 855lm/m 261lm/ft | | G |
| ● 3000K | 910lm/m 277lm/ft | | F |
| ● 4000K | 920lm/m 280lm/ft | | F |
| ● 5000K | 920lm/m 280lm/ft | | F |
| ● 6500K | 920lm/m 280lm/ft | | F |

Note: 'x' (CCT) = "27"(2700K) / "30"(3000K) / "40"(4000K) / "50"(5000K) / "60"(6000K), Please contact us for more information.
* Please contact our sales for the latest details and certifications

120LEDs/10M

Product NO.
AURR283509WW-24VCLM-10M

Technical Details

| | |
|-------------------------|---------------------|
| Power | 9.6W/M 2.93W/ft |
| Voltage | DC24V |
| CRI | 90 |
| Led Qty | 120LEDs/M 36LEDs/ft |
| Length/Reel | 10M 32.8ft |
| Cutting Length | 50mm 1.97" |
| PCB | 10mm 0.39" |
| Waterproof grade | IP20 |

| Lumens | | | ErP Class |
|---------|------------------|--|-----------|
| ● 2700K | 855lm/m 261lm/ft | | G |
| ● 3000K | 910lm/m 277lm/ft | | F |
| ● 4000K | 920lm/m 280lm/ft | | F |
| ● 5000K | 920lm/m 280lm/ft | | F |
| ● 6500K | 920lm/m 280lm/ft | | F |



Connectors List

| | | | | |
|-------------------------|-------------------------|-------------------------|------------------|---------------------------------|
| LD-SR Series | LD-SE Series | LD-SL Series | Clips | Cable Fast Connector |
|-------------------------|-------------------------|-------------------------|------------------|---------------------------------|

* Please Go to page 248 for Accessory and Connector Usage Guidelines.



Ultra-Long Series

24V Ultra-Long Series

Single end power feed carries up to 100M.
Constant current design, bring same brightness
from end to end.

24V Constant Current Series

Single end power feed carries up to 20M.
Constant current design, bring same brightness
from end to end.

48V Ultra-Long Series

Single end power feed carries up to 50M.
Constant current design, bring same brightness
from end to end.

24V Ultra-Long Series

70LEDs/M

UP TO 100M

Low voltage 24V ensures working safety. The single-ended input can reach to 100M, which solves many installation problems, such as the pre-buried position of the power supply.
Copper strand structure design, more sturdy.

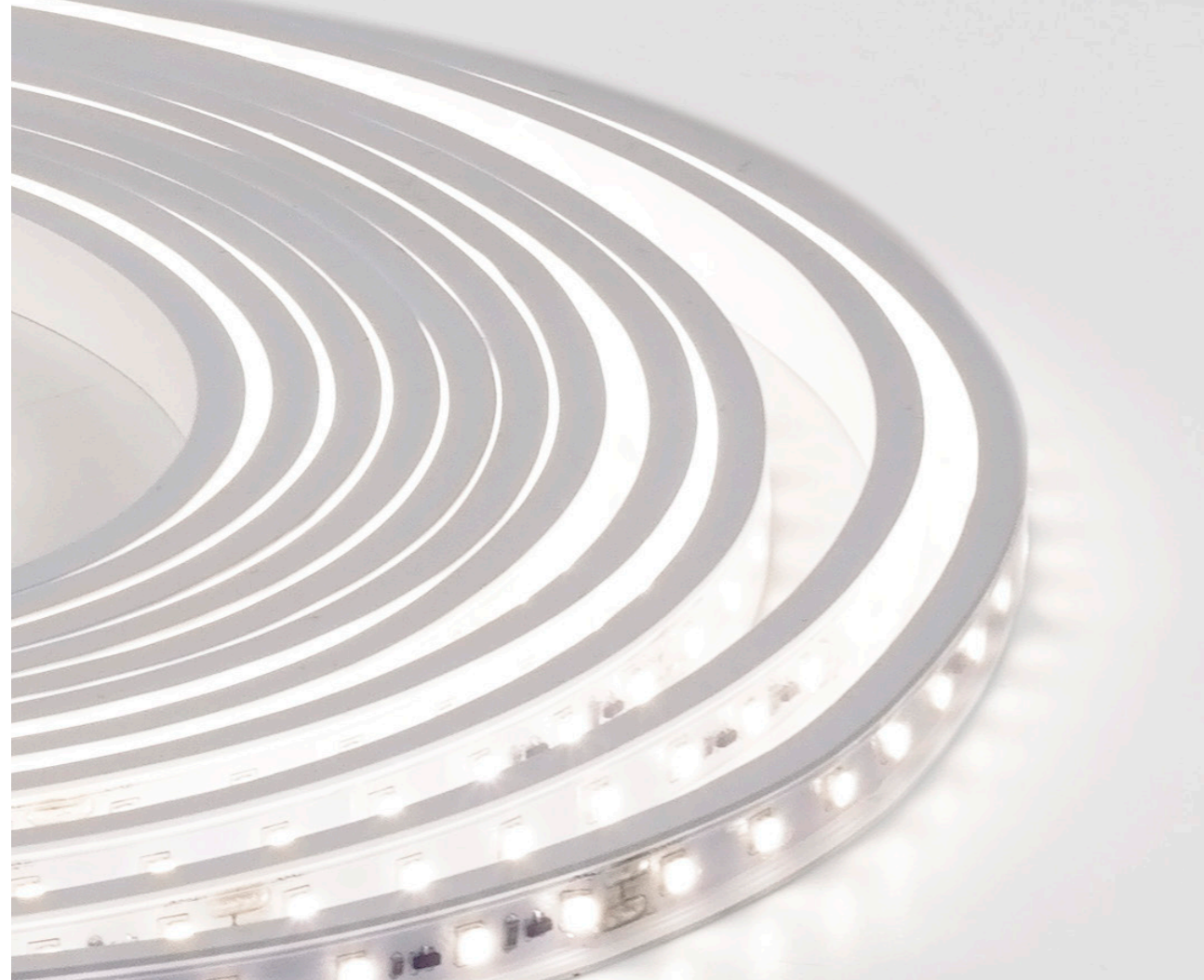

Dimension



* Please Go to page 108 for Accessory and Connector Usage Guidelines.

LED STRIP SERIES · ULTRA-LONG SERIES

LED STRIP SERIES · ULTRA-LONG SERIES

10M

Product NO. AUUL15WW-24VCLM-10M70L

| Power | 15W/M 4.6W/ft | Lumens | | |
|------------------|--------------------|---------|----------|----------|
| Voltage | DC24V | ● 2700K | 1480lm/m | 451lm/ft |
| CRI | 90 | ● 3000K | 1500lm/m | 457lm/ft |
| Led Qty | 70LEDs/m 21LEDs/ft | ● 4000K | 1550lm/m | 473lm/ft |
| Length/Reel | 10M 32.8ft | ● 5000K | 1520lm/m | 463lm/ft |
| Cutting Length | 100mm 3.93" | ● 6500K | 1520lm/m | 463lm/ft |
| Waterproof grade | IP65 | | | |

20M

Product NO. AUUL10WW-24VCLM-20M70L

| Power | 10W/m 3.05W/ft | Lumens | | |
|------------------|--------------------|---------|----------|----------|
| Voltage | DC24V | ● 2700K | 1040lm/m | 317lm/ft |
| CRI | 90 | ● 3000K | 1060lm/m | 323lm/ft |
| Led Qty | 70LEDs/m 21LEDs/ft | ● 4000K | 1110lm/m | 338lm/ft |
| Length/Reel | 20M 65.61ft | ● 5000K | 1090lm/m | 332lm/ft |
| Cutting Length | 100mm 3.93" | ● 6500K | 1090lm/m | 332lm/ft |
| Waterproof grade | IP65 | | | |

40M

Product NO. AUUL04WW-24VCLM-40M70L

| Power | 4.8W/M 1.46W/ft | Lumens | | |
|------------------|--------------------|---------|---------|----------|
| Voltage | DC24V | ● 2700K | 530lm/m | 162lm/ft |
| CRI | 90 | ● 3000K | 540lm/m | 165lm/ft |
| Led Qty | 70LEDs/m 21LEDs/ft | ● 4000K | 560lm/m | 171lm/ft |
| Length/Reel | 40M 131.23ft | ● 5000K | 550lm/m | 168lm/ft |
| Cutting Length | 100mm 3.93" | ● 6500K | 550lm/m | 168lm/ft |
| Waterproof grade | IP65 | | | |

100M

Product NO. AUUL02WW-24VCLM-100M70L

| Power | 2W/M 0.61W/ft | Lumens | | |
|------------------|--------------------|---------|---------|---------|
| Voltage | DC24V | ● 2700K | 260lm/m | 79lm/ft |
| CRI | 90 | ● 3000K | 270lm/m | 82lm/ft |
| Led Qty | 70LEDs/m 21LEDs/ft | ● 4000K | 280lm/m | 85lm/ft |
| Length/Reel | 100M 328.08ft | ● 5000K | 270lm/m | 82lm/ft |
| Cutting Length | 100mm 3.93" | ● 6500K | 270lm/m | 82lm/ft |
| Waterproof grade | IP65 | | | |

Note: 'x' (CCT) = "27"(2700K) / "30"(3000K) / "40"(4000K) / "50"(5000K) / "60"(6000K), Please contact us for more information.
* Please contact our sales for the latest details and certifications

24V Ultra-Long Series

120LEDs/M IP20



20M

Product NO. AUUL08WW-24VCLM-20M120L

| Power | 8.5W/M 2.59W/ft | Lumens | | |
|------------------|---------------------|---------|---------|----------|
| Voltage | DC24V | ● 2700K | 739lm/m | 225lm/ft |
| CRI | 90 | ● 3000K | 768lm/m | 234lm/ft |
| Led Qty | 120LEDs/M 36LEDs/ft | ● 4000K | 850lm/m | 259lm/ft |
| Length/Reel | 20M 65.61ft | ● 5000K | 820lm/m | 250lm/ft |
| Cutting Length | 50mm 1.97" | ● 6000K | 795lm/m | 242lm/ft |
| Waterproof grade | IP20 | | | |

Note: 'x' (CCT) = "27"(2700K) / "30"(3000K) / "40"(4000K) / "50"(5000K) / "60"(6000K), Please contact us for more information.

* Please contact our sales for the latest details and certifications

Dimension



Connectors List



* Please Go to page 248 for Accessory and Connector Usage Guidelines.

140LEDs/M IP65



10M

Product NO. AUUL20WW-24VCLM-10M120L

| Power | 20W/M 6.1W/ft | Lumens | | |
|------------------|---------------------|---------|----------|----------|
| Voltage | DC24V | ● 2700K | 2040lm/m | 622lm/ft |
| CRI | 90 | ● 3000K | 2100lm/m | 640lm/ft |
| Led Qty | 140LEDs/M 42LEDs/ft | ● 4000K | 2240lm/m | 683lm/ft |
| Length/Reel | 10M 32.8ft | ● 5000K | 2240lm/m | 683lm/ft |
| Cutting Length | 50mm 1.97" | ● 6500K | 2240lm/m | 683lm/ft |
| Waterproof grade | IP65 | | | |

15M

Product NO. AUUL15WW-24VCLM-15M120L

| Power | 15W/M 4.6W/ft | Lumens | | |
|------------------|---------------------|---------|----------|----------|
| Voltage | DC24V | ● 2700K | 1530lm/m | 466lm/ft |
| CRI | 90 | ● 3000K | 1590lm/m | 485lm/ft |
| Led Qty | 140LEDs/M 42LEDs/ft | ● 4000K | 1680lm/m | 512lm/ft |
| Length/Reel | 15M 49.21ft | ● 5000K | 1680lm/m | 512lm/ft |
| Cutting Length | 50mm 1.97" | ● 6500K | 1680lm/m | 512lm/ft |
| Waterproof grade | IP65 | | | |

20M

Product NO. AUUL10WW-24VCLM-20M120L

| Power | 10W/M 1.46W/ft | Lumens | | |
|------------------|---------------------|---------|----------|----------|
| Voltage | DC24V | ● 2700K | 1000lm/m | 305lm/ft |
| CRI | 90 | ● 3000K | 1050lm/m | 320lm/ft |
| Led Qty | 140LEDs/M 42LEDs/ft | ● 4000K | 1110lm/m | 338lm/ft |
| Length/Reel | 20M 65.61ft | ● 5000K | 1110lm/m | 338lm/ft |
| Cutting Length | 50mm 1.97" | ● 6500K | 1110lm/m | 338lm/ft |
| Waterproof grade | IP65 | | | |

Dimension



24V Ultra-Long Constant Current Series

1M-20M, Lumen Different : 0.25%

(Tested Sample: 20M 4.8W/M)

Under constant current condition, brightness output is more stable, life is longer.
20m Ultra-long strip driven by one end power supply.
The same brightness from end to end.



70LEDs/M 20M

IP20

Product NO. AUUL04WW-24VCLM-20M70L-D25I20

| Power | 4.8W/M 1.46W/ft | Lumens | | |
|------------------|--------------------|---------|---------|----------|
| Voltage | DC24V | ● 2700K | 545lm/m | 166lm/ft |
| CRI | 90 | ● 3000K | 575lm/m | 175lm/ft |
| Led Qty | 70LEDs/M 21LEDs/ft | ● 4000K | 595lm/m | 181lm/ft |
| Length/Reel | 20M 65.61ft | ● 5000K | 595lm/m | 181lm/ft |
| Cutting Length | 100mm 3.93" | ● 6500K | 595lm/m | 181lm/ft |
| Waterproof grade | IP20 | | | |

IP65

Product NO. AUUL04WW-24VCLM-20M70L-D25I65

| Power | 4.8W/M 1.46W/ft | Lumens | | |
|------------------|--------------------|---------|---------|----------|
| Voltage | DC24V | ● 2700K | 530lm/m | 162lm/ft |
| CRI | 90 | ● 3000K | 555lm/m | 169lm/ft |
| Led Qty | 70LEDs/M 21LEDs/ft | ● 4000K | 580lm/m | 177lm/ft |
| Length/Reel | 20M 65.61ft | ● 5000K | 580lm/m | 177lm/ft |
| Cutting Length | 100mm 3.93" | ● 6500K | 580lm/m | 177lm/ft |
| Waterproof grade | IP65 | | | |

Dimension

IP20



IP65

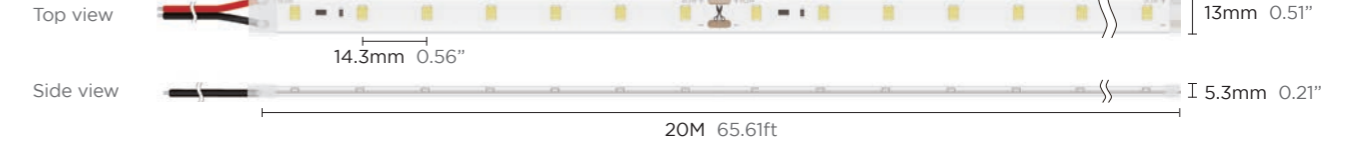

Connectors List



* Please Go to page 248 for Accessory and Connector Usage Guidelines.

24V Ultra-Long Constant Current Series

1M-20M, Lumen Different : 0.25%

(Tested Sample: 20M 4.8W/M)

Under constant current condition, brightness output is more stable, life is longer.
10m Ultra-long strip driven by one end power supply.
The same brightness from end to end.



LED STRIP SERIES · ULTRA-LONG SERIES



140LEDs/M 10M

IP20

Product NO. AUUL09WW-24VCLM-10M140L-D25I20

| Power | 9.6W/M 2.93W/ft | Lumens | | |
|------------------|---------------------|---------|----------|----------|
| Voltage | DC24V | ● 2700K | 1075lm/m | 328lm/ft |
| CRI | 90 | ● 3000K | 1115lm/m | 340lm/ft |
| Led Qty | 140LEDs/M 42LEDs/ft | ● 4000K | 1180lm/m | 360lm/ft |
| Length/Reel | 10M 32.8ft | ● 5000K | 1180lm/m | 360lm/ft |
| Cutting Length | 50mm 1.97" | ● 6500K | 1180lm/m | 360lm/ft |
| Waterproof grade | IP20 | | | |

IP65

Product NO. AUUL09WW-24VCLM-10M140L-D25I65

| Power | 9.6W/M 2.93W/ft | Lumens | | |
|------------------|---------------------|---------|----------|----------|
| Voltage | DC24V | ● 2700K | 1055lm/m | 322lm/ft |
| CRI | 90 | ● 3000K | 1105lm/m | 337lm/ft |
| Led Qty | 140LEDs/M 42LEDs/ft | ● 4000K | 1150lm/m | 351lm/ft |
| Length/Reel | 10M 32.8ft | ● 5000K | 1150lm/m | 351lm/ft |
| Cutting Length | 50mm 1.97" | ● 6500K | 1150lm/m | 351lm/ft |
| Waterproof grade | IP65 | | | |

Dimension

IP20

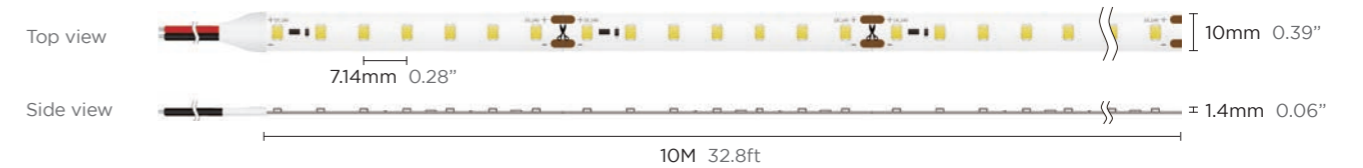

IP65

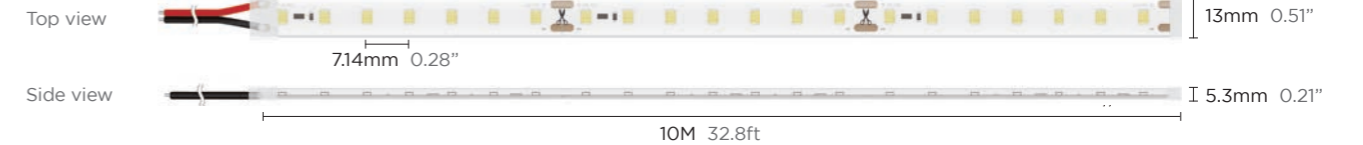

Connectors List



* Please Go to page 248 for Accessory and Connector Usage Guidelines.

LED STRIP SERIES · ULTRA-LONG SERIES

48V Ultra-Long Series

Single end power carries up to 50M.
Uniform brightness from end to end.

Regular
Mini Cut
High Efficiency
Tunable White
Mini Size
RGB
RGBW

48V Ultra-Long Series Regular

Single end power carries 50M.
Uniform brightness from end to end.
Up to 106LM/W.
Easy to Install & save time.



Dimension

IP20



IP65



Connectors List

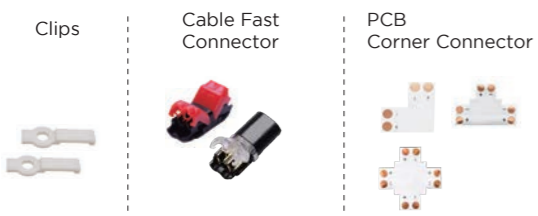

* Please Go to page 248 for Accessory and Connector Usage Guidelines.

40M / 72LEDs / PCB 8MM

IP20/4.8W

Product NO. AUUL04WW-48VCLM-40M72L-I20

| Power | 4.8W/M 1.46W/ft | Lumens | | ErP Class | |
|------------------|--------------------|---------|------------------|-----------|--|
| Voltage | DC48V | ● 2700K | 440lm/m 134lm/ft | G | |
| CRI | 90 | ● 3000K | 480lm/m 146lm/ft | F | |
| Led Qty | 72LEDs/M 21LEDs/ft | ● 4000K | 510lm/m 155lm/ft | F | |
| Cutting Length | 166.67mm 6.56" | ● 5000K | 510lm/m 155lm/ft | F | |
| Length/Reel | 40m 131.23ft | ● 6500K | 510lm/m 155lm/ft | F | |
| Waterproof grade | IP20 | | | | |

IP65/4.8W

Product NO. AUUL04WW-48VCLM-40M72L-I65

| Power | 4.8W/M 1.46W/ft | Lumens | | ErP Class | |
|------------------|--------------------|---------|------------------|-----------|--|
| Voltage | DC48V | ● 2700K | 415lm/m 127lm/ft | G | |
| CRI | 90 | ● 3000K | 435lm/m 133lm/ft | F | |
| Led Qty | 72LEDs/M 21LEDs/ft | ● 4000K | 485lm/m 148lm/ft | F | |
| Cutting Length | 166.67mm 6.56" | ● 5000K | 485lm/m 148lm/ft | F | |
| Length/Reel | 40m 131.23ft | ● 6500K | 485lm/m 148lm/ft | F | |
| Waterproof grade | IP65 | | | | |

50M / 72LEDs / PCB 10MM

IP20/4.8W

Product NO. AUUL04WW-48VCLM-50M72L-I20

| Power | 4.8W/M 1.46W/ft | Lumens | | ErP Class | |
|------------------|--------------------|---------|------------------|-----------|--|
| Voltage | DC48V | ● 2700K | 440lm/m 134lm/ft | G | |
| CRI | 90 | ● 3000K | 455lm/m 139lm/ft | F | |
| Led Qty | 72LEDs/M 21LEDs/ft | ● 4000K | 490lm/m 149lm/ft | F | |
| Cutting Length | 166.67mm 6.56" | ● 5000K | 490lm/m 149lm/ft | F | |
| Length/Reel | 50m 164.04ft | ● 6500K | 490lm/m 149lm/ft | F | |
| Waterproof grade | IP20 | | | | |

IP65/4.8W

Product NO. AUUL04WW-48VCLM-50M72L-I65

| Power | 4.8W/M 1.46W/ft | Lumens | | ErP Class | |
|------------------|-----------------|---------|------------------|-----------|--|
| Voltage | DC48V | ● 2700K | 425lm/m 130lm/ft | G | |
| CRI | 90 | ● 3000K | 455lm/m 139lm/ft | F | |
| Led Qty | 72LEDs/M | ● 4000K | 490lm/m 149lm/ft | F | |
| Cutting Length | 166.67mm 6.56" | ● 5000K | 490lm/m 149lm/ft | F | |
| Length/Reel | 50m 164.04ft | ● 6500K | 490lm/m 149lm/ft | F | |
| Waterproof grade | IP65 | | | | |

Note: 'x' (CCT) = "27"(2700K) / "30"(3000K) / "40"(4000K) / "50"(5000K) / "60"(6000K), Please contact us for more information.

* Please contact our sales for the latest details and certifications

48V Ultra-Long Series Regular

Single end power carries 50M.
Uniform brightness from end to end.
Up to 106LM/W.
Easy to install & save time.



Dimension

IP20



IP65

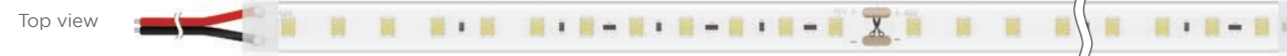

Connectors List

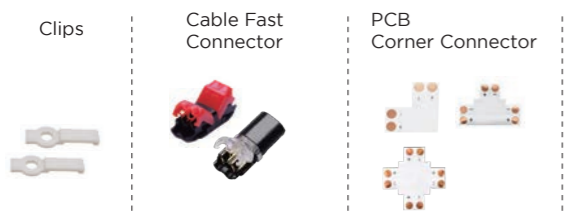

* Please Go to page 248 for Accessory and Connector Usage Guidelines.

40M / 120LEDs / PCB 8MM

IP20/8W

Product NO. AUUL08WW-48VCLM-40M120L-I20

| Power | 8W/M 2.43W/ft | Lumens | | | ErP Class |
|------------------|---------------------|---------|---------|----------|-----------|
| Voltage | DC48V | ● 2700K | 720lm/m | 220lm/ft | G |
| CRI | 90 | ● 3000K | 775lm/m | 236lm/ft | F |
| Led Qty | 120LEDs/M 36LEDs/ft | ● 4000K | 850lm/m | 259lm/ft | F |
| Cutting Length | 100mm 3.93" | ● 5000K | 850lm/m | 259lm/ft | F |
| Length/Reel | 40m 131.23ft | ● 6500K | 850lm/m | 259lm/ft | F |
| Waterproof grade | IP20 | | | | |

IP65/8W

Product NO. AUUL08WW-48VCLM-40M120L-I65

| Power | 8W/M 2.43W/ft | Lumens | | | ErP Class |
|------------------|---------------------|---------|---------|----------|-----------|
| Voltage | DC48V | ● 2700K | 700lm/m | 213lm/ft | G |
| CRI | 90 | ● 3000K | 735lm/m | 224lm/ft | F |
| Led Qty | 120LEDs/M 36LEDs/ft | ● 4000K | 825lm/m | 252lm/ft | F |
| Cutting Length | 100mm 3.93" | ● 5000K | 825lm/m | 252lm/ft | F |
| Length/Reel | 40m 131.23ft | ● 6500K | 825lm/m | 252lm/ft | F |
| Waterproof grade | IP65 | | | | |

50M / 120LEDs / PCB 10MM

IP20/8W

Product NO. AUUL08WW-48VCLM-50M120L-I20

| Power | 8W/M 2.43W/ft | Lumens | | | ErP Class |
|------------------|---------------------|---------|---------|----------|-----------|
| Voltage | DC48V | ● 2700K | 720lm/m | 220lm/ft | G |
| CRI | 90 | ● 3000K | 770lm/m | 235lm/ft | F |
| Led Qty | 120LEDs/M 36LEDs/ft | ● 4000K | 850lm/m | 259lm/ft | F |
| Cutting Length | 100mm 3.93" | ● 5000K | 850lm/m | 259lm/ft | F |
| Length/Reel | 50m 164.04ft | ● 6500K | 850lm/m | 259lm/ft | F |
| Waterproof grade | IP20 | | | | |

IP65/8W

Product NO. AUUL08WW-48VCLM-50M120L-I65

| Power | 8W/M 2.43W/ft | Lumens | | | ErP Class |
|------------------|---------------------|---------|---------|----------|-----------|
| Voltage | DC48V | ● 2700K | 705lm/m | 215lm/ft | G |
| CRI | 90 | ● 3000K | 765lm/m | 233lm/ft | F |
| Led Qty | 120LEDs/M 36LEDs/ft | ● 4000K | 840lm/m | 256lm/ft | F |
| Cutting Length | 100mm 3.93" | ● 5000K | 840lm/m | 256lm/ft | F |
| Length/Reel | 50m 164.04ft | ● 6500K | 840lm/m | 256lm/ft | F |
| Waterproof grade | IP65 | | | | |

Note: 'x' (CCT) = "27"(2700K) / "30"(3000K) / "40"(4000K) / "50"(5000K) / "60"(6000K), Please contact us for more information.

* Please contact our sales for the latest details and certifications

48V Ultra-Long Series Mini Cut

Single end power carries 50M.
Uniform brightness from end to end.
Up to 106LM/W.
Easy to install & save time.

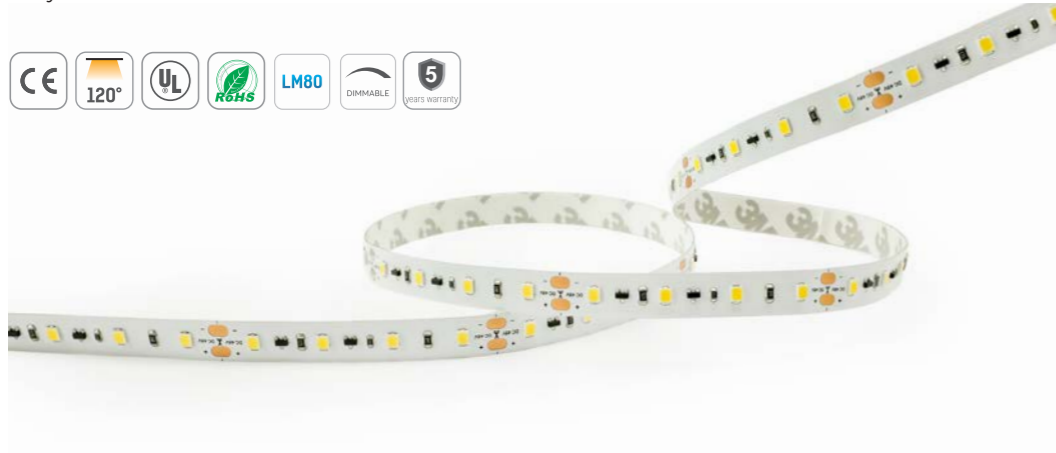

Dimension

IP20



IP65



Connectors List

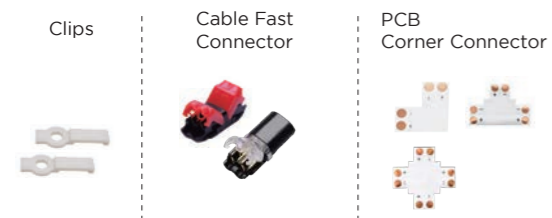

* Please Go to page 248 for Accessory and Connector Usage Guidelines.

40M / 64LEDs / PCB 10MM

IP20 / 4.8W

Product NO.

AUUL04WW-48VCLM-40M64L-I20

| Technical Details | | Lumens | | ErP Class |
|-------------------|--------------------|---------|------------------|-----------|
| Power | 4.8W/M 1.46W/ft | ● 2700K | 455lm/m 139lm/ft | F |
| Voltage | DC48V | ● 3000K | 470lm/m 143lm/ft | F |
| CRI | 90 | ● 4000K | 485lm/m 148lm/ft | F |
| Led Qty | 64LEDs/M 19LEDs/ft | ● 5000K | 485lm/m 148lm/ft | F |
| Cutting Length | 62.5mm 2.46" | ● 6000K | 485lm/m 148lm/ft | F |
| Length/Reel | 40m 131.23ft | | | |
| Waterproof grade | IP20 | | | |

20M / 64LEDs / PCB 10MM

IP65 / 4.8W

Product NO.

AUUL04WW-48VCLM-20M64L-I65

| Technical Details | | Lumens | | ErP Class |
|-------------------|--------------------|---------|------------------|-----------|
| Power | 4.8W/M 1.46W/ft | ● 2700K | 435lm/m 133lm/ft | G |
| Voltage | DC48V | ● 3000K | 445lm/m 136lm/ft | F |
| CRI | 90 | ● 4000K | 455lm/m 139lm/ft | F |
| Led Qty | 64LEDs/M 19LEDs/ft | ● 5000K | 455lm/m 139lm/ft | F |
| Cutting Length | 62.5mm 2.46" | ● 6000K | 455lm/m 139lm/ft | F |
| Length/Reel | 20m 65.61ft | | | |
| Waterproof grade | IP65 | | | |



48V Ultra-Long Series

High Efficiency

Single end power carries 50M.
Uniform brightness from end to end.
Up to 106LM/W.
Easy to install & save time.



Dimension

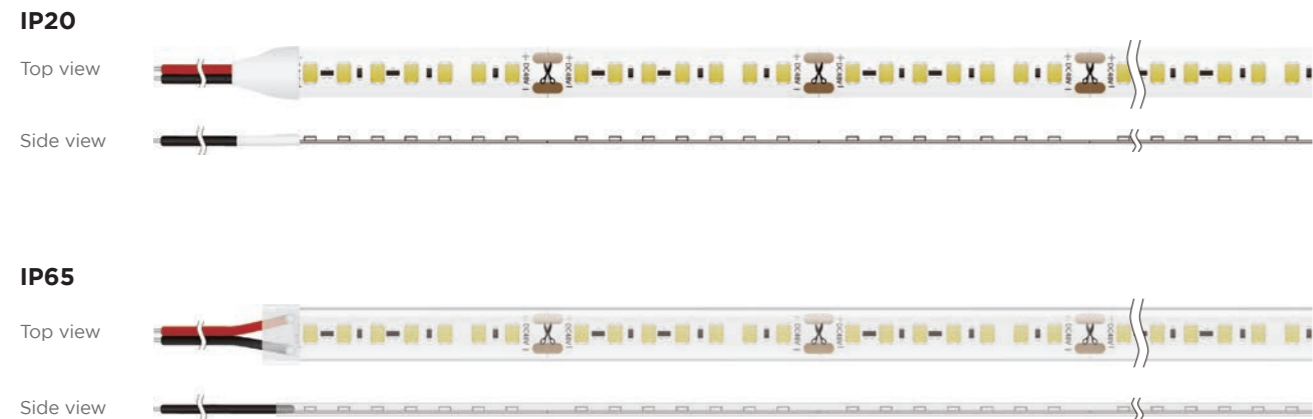

Connectors List

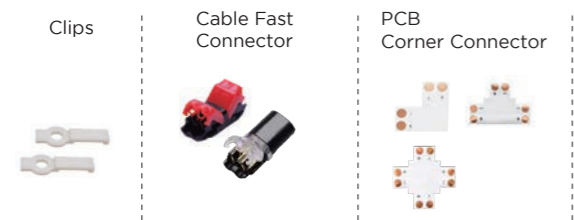

* Please Go to page 248 for Accessory and Connector Usage Guidelines.

20M / 140LEDs / PCB 10MM

IP20/14.4W

Product NO. AUUL14WW-48VCLM-20M140L-I20

| Power | 14.4W/M 4.39W/ft | Lumens | | | ErP Class |
|------------------|---------------------|---------|----------|----------|-----------|
| Voltage | DC48V | ● 2700K | 1730lm/m | 527lm/ft | E |
| CRI | 90 | ● 3000K | 1870lm/m | 570lm/ft | E |
| Led Qty | 140LEDs/M 42LEDs/ft | ● 4000K | 1885lm/m | 575lm/ft | E |
| Cutting Length | 50mm 1.97" | ● 5000K | 1885lm/m | 575lm/ft | E |
| Length/Reel | 20m 65.61ft | ● 6500K | 1885lm/m | 575lm/ft | E |
| Waterproof grade | IP20 | | | | |

IP65/14.4W

Product NO. AUUL14WW-48VCLM-20M140L-I65

| Power | 14.4W/M 4.39W/ft | Lumens | | | ErP Class |
|------------------|---------------------|---------|----------|----------|-----------|
| Voltage | DC48V | ● 2700K | 1670lm/m | 509lm/ft | F |
| CRI | 90 | ● 3000K | 1800lm/m | 549lm/ft | E |
| Led Qty | 140LEDs/M 42LEDs/ft | ● 4000K | 1825lm/m | 556lm/ft | E |
| Cutting Length | 50mm 1.97" | ● 5000K | 1825lm/m | 556lm/ft | E |
| Length/Reel | 20m 65.61ft | ● 6500K | 1825lm/m | 556lm/ft | E |
| Waterproof grade | IP65 | | | | |

10M / 140LEDs / PCB 10MM

IP20/19.2W

Product NO. AUUL19WW-48VCLM-10M140L-I20

| Power | 19.2W/M 5.94W/ft | Lumens | | | ErP Class |
|------------------|---------------------|---------|----------|----------|-----------|
| Voltage | DC48V | ● 2700K | 2340lm/m | 713lm/ft | E |
| CRI | 90 | ● 3000K | 2515lm/m | 767lm/ft | E |
| Led Qty | 140LEDs/M 42LEDs/ft | ● 4000K | 2550lm/m | 777lm/ft | E |
| Cutting Length | 50mm 1.97" | ● 5000K | 2550lm/m | 777lm/ft | E |
| Length/Reel | 10m 32.8ft | ● 6500K | 2550lm/m | 777lm/ft | E |
| Waterproof grade | IP20 | | | | |

IP65/19.2W

Product NO. AUUL19WW-48VCLM-10M140L-I65

| Power | 19.2W/M 5.94W/ft | Lumens | | | ErP Class |
|------------------|---------------------|---------|----------|----------|-----------|
| Voltage | DC48V | ● 2700K | 2225lm/m | 678lm/ft | F |
| CRI | 90 | ● 3000K | 2400lm/m | 732lm/ft | E |
| Led Qty | 140LEDs/M 42LEDs/ft | ● 4000K | 2420lm/m | 738lm/ft | E |
| Cutting Length | 50mm 1.97" | ● 5000K | 2420lm/m | 738lm/ft | E |
| Length/Reel | 10m 32.8ft | ● 6500K | 2420lm/m | 738lm/ft | E |
| Waterproof grade | IP65 | | | | |

Note: 'x' (CCT) = "27"(2700K) / "30"(3000K) / "40"(4000K) / "50"(5000K) / "60"(6000K), Please contact us for more information.

* Please contact our sales for the latest details and certifications

48V Ultra-Long Series Mini Size

Single end power carries 10M.
Uniform brightness from end to end.
Up to 100LM/W.
Easy to install & save time.



10M / 208LEDs / PCB4MM

IP20 / 8W

Product NO.
AUUL08WW-48VCLM-10M208L-I20mini

Technical Details

| | |
|-------------------------|---------------------|
| Power | 8W/M 2.43W/ft |
| Voltage | DC48V |
| CRI | 90 |
| Led Qty | 208LEDs/M 63LEDs/ft |
| Cutting Length | 62.5mm 2.46" |
| Length/Reel | 10m 32.8ft |
| Waterproof grade | IP20 |

Lumens

| | | | |
|---------|---------|----------|----------|
| ● 2700K | 720lm/m | 220lm/ft | G |
| ● 3000K | 816lm/m | 249lm/ft | F |
| ● 4000K | 880lm/m | 268lm/ft | F |
| ● 5000K | 880lm/m | 268lm/ft | F |
| ● 6000K | 880lm/m | 268lm/ft | F |

ErP Class

| |
|----------|
| G |
| F |
| F |
| F |
| F |

Dimension

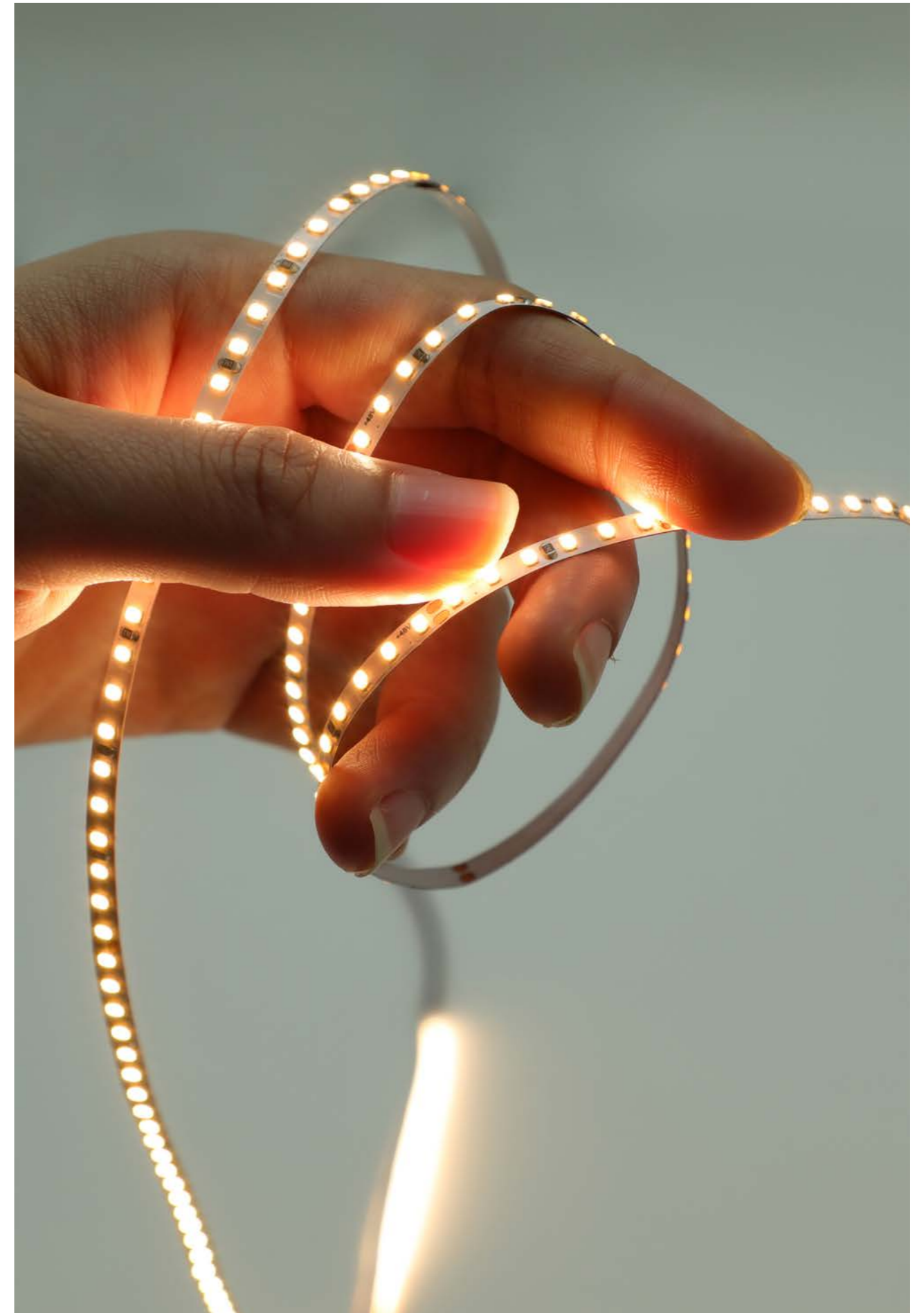

48V Ultra-Long Series Tunable White

Single end power carries 20M.
Uniform brightness from end to end.
Easy to install & save time.



20M / 140LEDs / PCB10MM

IP20 / 14W

Product NO.
AUUL14WW-48VCLM-20M140L-I20mini

Technical Details

| | |
|-------------------------|---------------------|
| Power | 14W/M 4.26W/ft |
| Voltage | DC48V |
| CRI | 90 |
| Led Qty | 140LEDs/M 42LEDs/ft |
| Cutting Length | 100mm 1.97" |
| Length/Reel | 20m 65.61ft |
| Waterproof grade | IP20 / IP65 |

Lumens

| | | |
|---------|---------|----------|
| ● 2700K | 860lm/m | 262lm/ft |
| ● 6000K | 960lm/m | 293lm/ft |

Dimension



48V Ultra-Long Series RGB

Single end power carries 20M.
Uniform brightness from end to end.
Easy to install & save time.



20M / 66LEDs / PCB10MM

IP20 / 13W

Product NO.
AUUL13WR-48VCLM-20M66L-I20mini

Technical Details

| | |
|-------------------------|--------------------|
| Power | 13W/M 3.96W/ft |
| Voltage | DC48V |
| CRI | - (S050) |
| Led Qty | 66LEDs/M 20LEDs/ft |
| Cutting Length | 166.67mm 6.56" |
| Length/Reel | 20m 65.61ft |
| Waterproof grade | IP20 / IP65 |



Lumens

| | | |
|-----|---------|----------|
| ● R | 150lm/m | 46lm/ft |
| ● G | 380lm/m | 116lm/ft |
| ● B | 75lm/m | 23lm/ft |

Dimension



48V Ultra-Long Series RGBW

Single end power carries 20M.
Uniform brightness from end to end.
Easy to install & save time.



20M / 88LEDs / PCB12MM

IP20 / 15W

Product NO.
AUUL15WRW-48VCLM-20M88L-I20

Technical Details

| | |
|-------------------------|--------------------|
| Power | 15W/M 4.57W/ft |
| Voltage | DC48V |
| CRI | - (5050) |
| Led Qty | 88LEDs/M 26LEDs/ft |
| Cutting Length | 125mm 4.92" |
| Length/Reel | 20m 65.61ft |
| Waterproof grade | IP20 / IP65 |



Lumens

| | | |
|---------|---------|----------|
| ● R | 150lm/m | 46lm/ft |
| ● G | 380lm/m | 116lm/ft |
| ● B | 75lm/m | 23lm/ft |
| ● 3000K | 305lm/m | 93lm/ft |

Dimension



Mini LED

2216 Plus
2110 Series

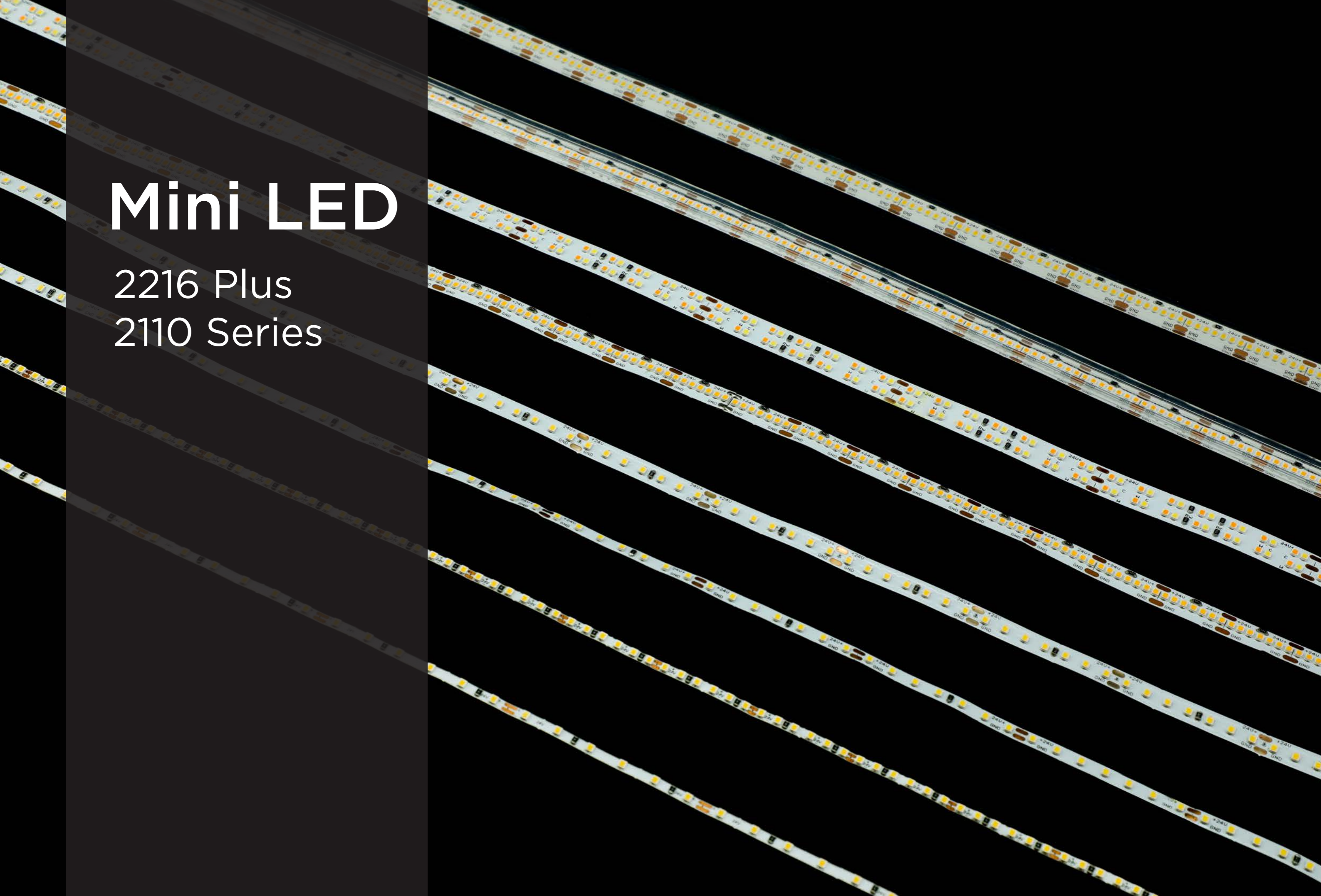

2216 Plus Series

Reinforced Bracket, better bending resistance.
Smaller led, more space for marvelous design.
Matched with various aluminum profiles and optical covers,
no dots, to meet different lighting design requirements.

LED STRIP SERIES · 2216 PLUS SERIES

Mini PCB 4 / 6mm

7LEDs/Group



4/6mm PCB width, applied for ultra-narrow gap profiles and grooves to reach slimmer lighting performance.

| | 168LEDs/M PCB4mm | 196LEDs/M PCB6MM |
|-------------------------|------------------------------|------------------------------|
| Product NO. | AUPS04WW-24VCLM-168L-I20mini | AUPS09WW-24VCLM-196L-I20mini |
| Power | 4.8W/M 1.46W/ft | 9.6W/M 2.93W/ft |
| Voltage | DC24V | DC24V |
| CRI | 90 | 90 |
| Led Qty | 168LEDs/M 51LEDs/ft | 196LEDs/M 60LEDs/ft |
| Length/Reel | 5M 16.41ft | 5M 16.41ft |
| Cutting Length | 41.67mm 1.64" | 35.7mm 1.41" |
| Waterproof grade | IP20 | IP20 |
| 2700K | 510lm/m 155lm/ft | 985lm/m 300lm/ft |
| 3000K | 525lm/m 160lm/ft | 1005lm/m 306lm/ft |
| 4000K | 545lm/m 166lm/ft | 1055lm/m 322lm/ft |
| 5000K | 545lm/m 166lm/ft | 1055lm/m 322lm/ft |
| 6000K | 545lm/m 166lm/ft | 1055lm/m 322lm/ft |

Note: 'x' (CCT) = 27*(2700K) / 30*(3000K) / 40*(4000K) / 50*(5000K) / 60*(6000K). Please contact us for more information.
* Please contact our sales for the latest details and certifications

LED STRIP SERIES · 2216 PLUS SERIES

Dimension

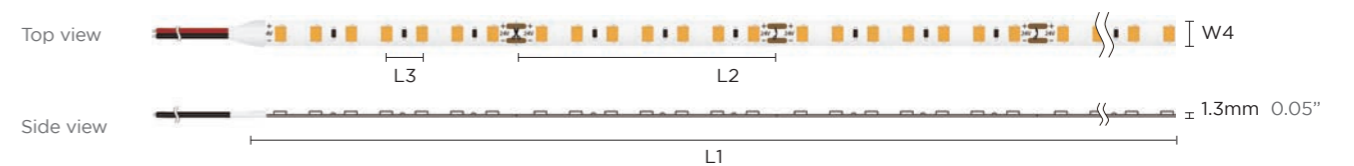

| | L1 | L2 | L3 | W4 |
|------------------------------|------------|---------------|--------------|-----------|
| AUPS04WW-24VCLM-168L-I20mini | 5m 16.41ft | 41.67mm 1.64" | 5.95mm 0.23" | 4mm 0.16" |
| AUPS09WW-24VCLM-196L-I20mini | 5m 16.41ft | 35.7mm 1.41" | 5.1mm 0.2" | 6mm 0.24" |

420LEDs/m 12W

7LEDs/Group



| | | | | |
|-------------------------|------------------------------|---------|----------|----------|
| Product NO. | AUPS12WW-24VCLM-420L-I20mini | Lumens | | |
| Power | 12W/M 3.66W/ft | ● 2700K | 1295lm/m | 395lm/ft |
| Voltage | DC24V | ● 3000K | 1320lm/m | 402lm/ft |
| CRI | 90 | ● 4000K | 1355lm/m | 413lm/ft |
| Led Qty | 420LEDs/M 128LEDs/ft | ● 5000K | 1355lm/m | 413lm/ft |
| Length/Reel | 5M 16.41ft | ● 6000K | 1355lm/m | 413lm/ft |
| Cutting Length | 16.67mm 0.66" | | | |
| Waterproof grade | IP20 | | | |

Note: 'x' (CCT) = "27"(2700K) / "30"(3000K) / "40"(4000K) / "50"(5000K) / "60"(6000K), Please contact us for more information.
 * Please contact our sales for the latest details and certifications

LED STRIP SERIES · 2216 PLUS SERIES

504LEDs/m 14W

7LEDs/Group / Tunable White



| | | | | |
|-------------------------|------------------------------|---------|---------|----------|
| Product NO. | AUPS14WW-24VCLM-504L-I20mini | Lumens | | |
| Power | 14W/M 4.27W/ft | ● 2700K | 745lm/m | 227lm/ft |
| Voltage | DC24V | ● 3000K | 780lm/m | 238lm/ft |
| CRI | 90 | | | |
| Led Qty | 504LEDs/M 154LEDs/ft | | | |
| Length/Reel | 5M 16.41ft | | | |
| Cutting Length | 55.56mm 2.19" | | | |
| Waterproof grade | IP20 | | | |

Note: 'x' (CCT) = "27"(2700K) / "30"(3000K) / "40"(4000K) / "50"(5000K) / "60"(6000K), Please contact us for more information.
 * Please contact our sales for the latest details and certifications

LED STRIP SERIES · 2216 PLUS SERIES

Dimension

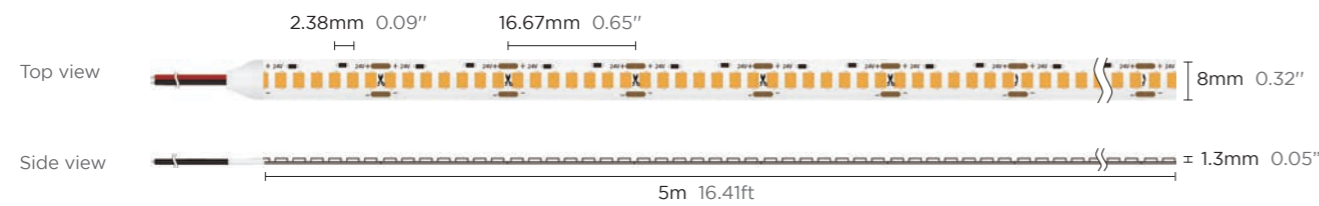

Dimension

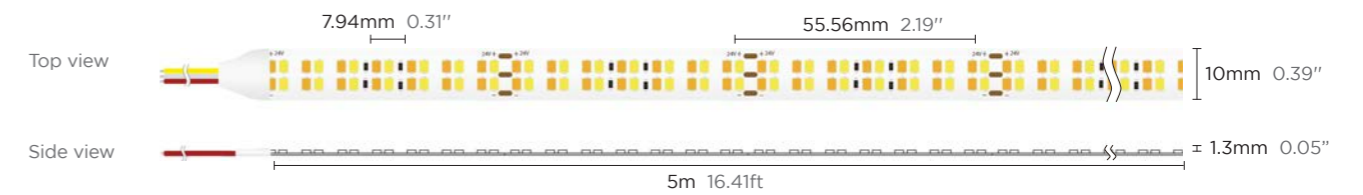

Connectors List



* Please Go to page 248 for Accessory and Connector Usage Guidelines.

Connectors List



* Please Go to page 248 for Accessory and Connector Usage Guidelines.



420LEDs/m 12W IP65

7LEDs/Group



| Product NO. | AUPS12WW-24VCLM-420L-I65mini | Lumens | | |
|------------------|------------------------------|---------|----------|----------|
| Power | 12W/M 3.66W/ft | ● 2700K | 1235lm/m | 377lm/ft |
| Voltage | DC24V | ● 3000K | 1245lm/m | 380lm/ft |
| CRI | 90 | ● 4000K | 1260lm/m | 384lm/ft |
| Led Qty | 420LEDs/M 128LEDs/ft | ● 5000K | 1260lm/m | 384lm/ft |
| Length/Reel | 5M 16.41ft | ● 6000K | 1260lm/m | 384lm/ft |
| Cutting Length | 16.67mm 0.66" | | | |
| Waterproof grade | IP65 | | | |

Note:'x' (CCT) = "27"(2700K) / "30"(3000K) / "40"(4000K) / "50"(5000K) / "60"(6000K), Please contact us for more information.

* Please contact our sales for the latest details and certifications

Dimension

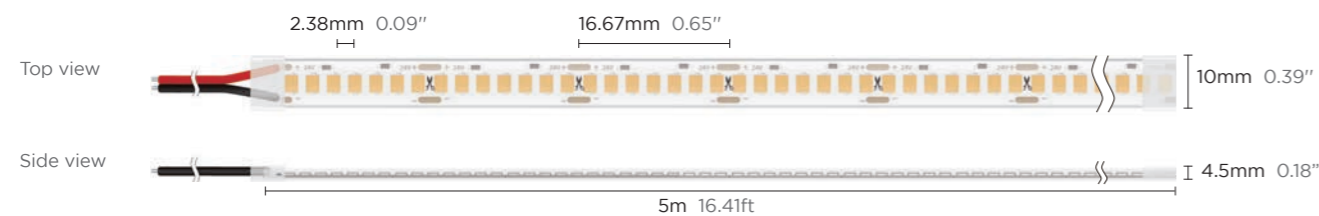

420LEDs/m 12W IP67

7LEDs/Group



| Product NO. | AUPS12WW-24VCLM-420L-I67mini | Lumens | | |
|------------------|------------------------------|---------|----------|----------|
| Power | 12W/M 3.66W/ft | ● 2700K | 1140lm/m | 348lm/ft |
| Voltage | DC24V | ● 3000K | 1165lm/m | 355lm/ft |
| CRI | 90 | ● 4000K | 1185lm/m | 361lm/ft |
| Led Qty | 420LEDs/M 128LEDs/ft | ● 5000K | 1185lm/m | 361lm/ft |
| Length/Reel | 5M 16.41ft | ● 6000K | 1185lm/m | 361lm/ft |
| Cutting Length | 16.67mm 0.66" | | | |
| Waterproof grade | IP67 | | | |

Note:'x' (CCT) = "27"(2700K) / "30"(3000K) / "40"(4000K) / "50"(5000K) / "60"(6000K), Please contact us for more information.

* Please contact our sales for the latest details and certifications

Dimension

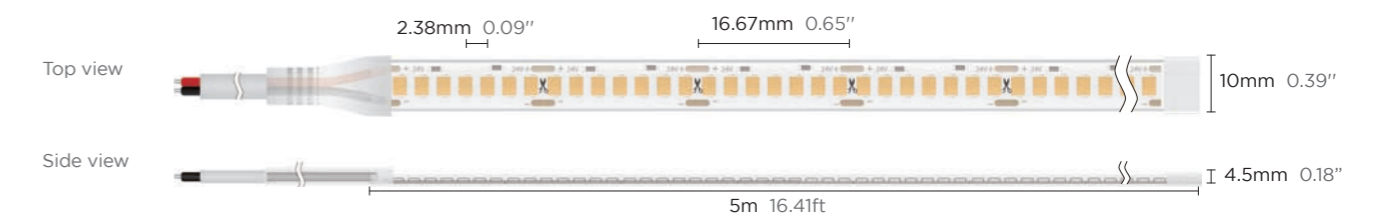

2110 Series

Reinforced Bracket, better bending resistance.
 Smaller led, more space for marvelous design.
 Matched with various aluminum profiles and optical covers,
 no dots, to meet different lighting design requirements.

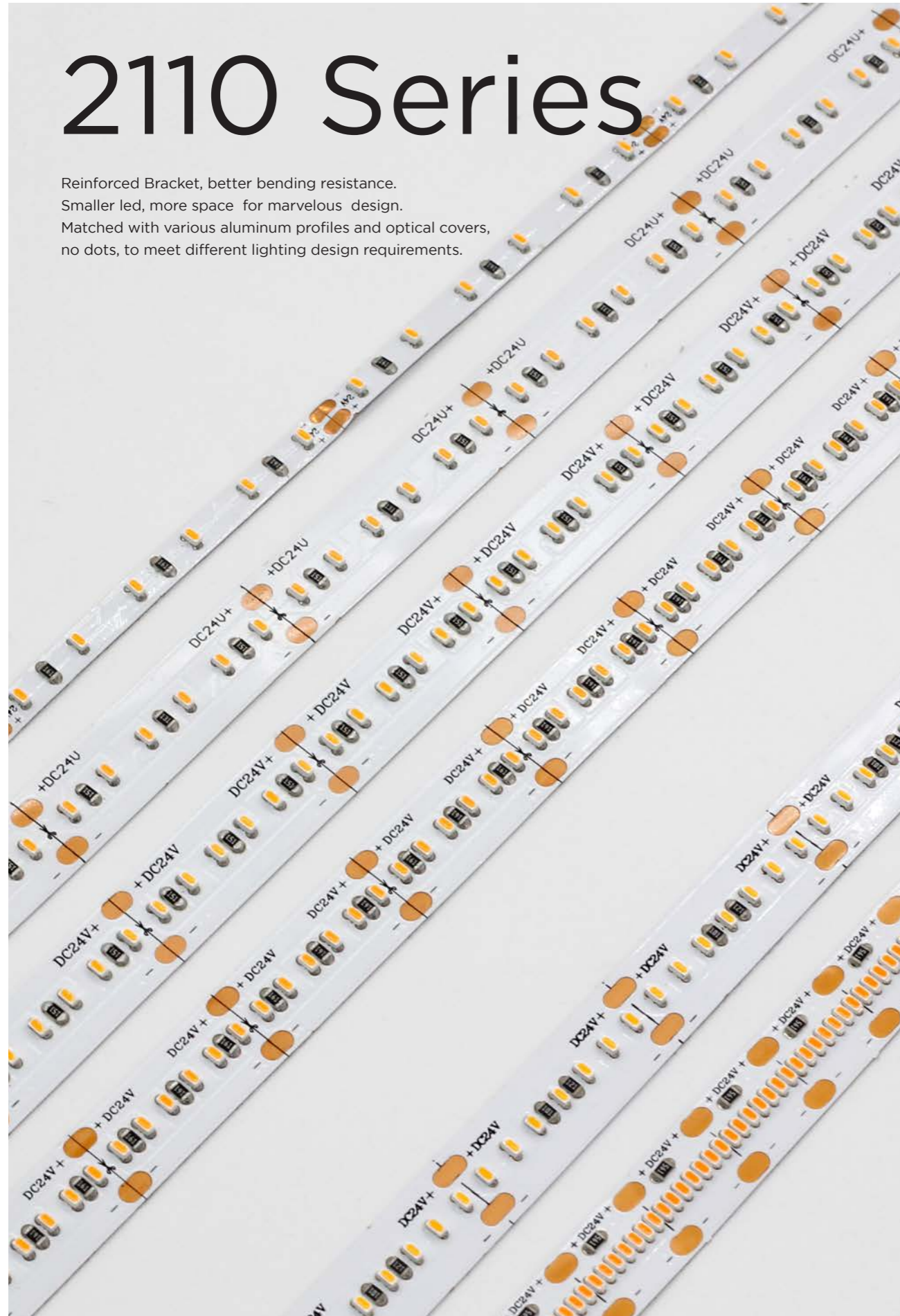

LED STRIP SERIES · 2110 SERIES

120LEDs/M 7.2W 6LEDs/Group

Product NO. AUPS07WW-24VCLM-120L-2110



4mm PCB width, applied for ultra-narrow gap profiles and grooves to reach slimmer lighting performance.



Mini PCB 4mm

Technical Details

| Technical Details | | Lumens | |
|-------------------|---------------------|---------|------------------|
| Power | 7.2W/M 2.20W/ft | ● 2200K | 500lm/m 152lm/ft |
| Voltage | DC24V | ● 2500K | 520lm/m 159lm/ft |
| CRI | 90 | ● 2700K | 530lm/m 162lm/ft |
| Led Qty | 120LEDs/M 36LEDs/ft | ● 3000K | 580lm/m 177lm/ft |
| Length/Reel | 5M 16.41ft | ● 4000K | 620lm/m 189lm/ft |
| Cutting Length | 50mm 1.97" | ● 5000K | 610lm/m 186lm/ft |
| Waterproof grade | IP20 | ● 6000K | 600lm/m 183lm/ft |

Note: 'x' (CCT) = 27°(2700K) / 30°(3000K) / 40°(4000K) / 50°(5000K) / 60°(6000K). Please contact us for more information.
 * Please contact our sales for the latest details and certifications

Dimension

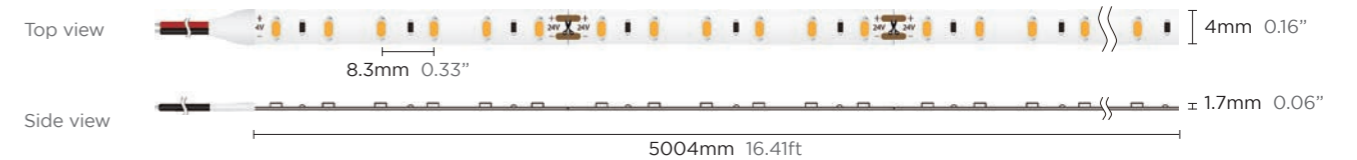

LED STRIP SERIES · 2110 SERIES

180LEDs/M 12W

6LEDs/Group

Product NO. AUPS12WW-24VCLM-180L-2110



Small size 2110, strong bracket, bending resistant.
High Density, combines AL profile and PC cover to create dot-free light.



Waterproof grade

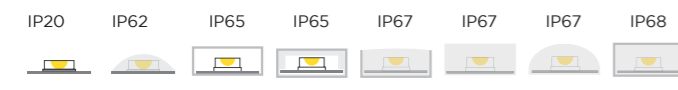

Technical Details

| Technical Details | | Lumens | |
|-------------------|--------------------------|---------|-------------------|
| Power | 12W/M 3.66W/ft | ● 2200K | 800lm/m 244lm/ft |
| Voltage | DC24V | ● 2500K | 850lm/m 259lm/ft |
| CRI | 90 | ● 2700K | 870lm/m 265lm/ft |
| Led Qty | 180LEDs/M 54LEDs/ft | ● 3000K | 960lm/m 293lm/ft |
| Length/Reel | 5M 16.41ft | ● 4000K | 1030lm/m 314lm/ft |
| Cutting Length | 33.3mm 1.31" | ● 5000K | 1010lm/m 38lm/ft |
| Waterproof grade | IP20/IP62/IP65/IP67/IP68 | ● 6000K | 1000lm/m 305lm/ft |

Note: 'x' (CCT) = "27"(2700K) / "30"(3000K) / "40"(4000K) / "50"(5000K) / "60"(6000K), Please contact us for more information.
* Please contact our sales for the latest details and certifications

Dimension

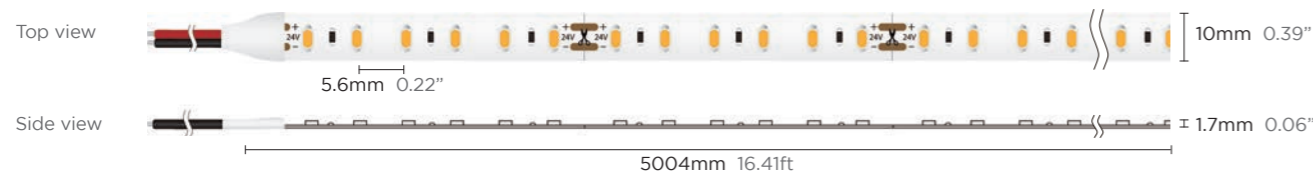

Connectors List

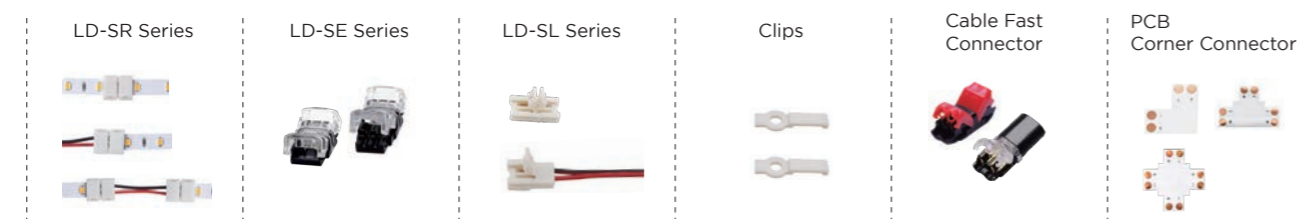

* Please Go to page 248 for Accessory and Connector Usage Guidelines.

240LEDs/M 15W

6LEDs/Group

Product NO. AUPS15WW-24VCLM-240L-2110



Small size 2110, strong bracket, bending resistant.
High Density, combines AL profile and PC cover to create dot-free light.



Waterproof grade

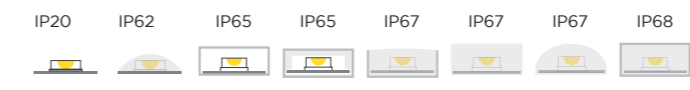

Technical Details

| Technical Details | | Lumens | |
|-------------------|--------------------------|---------|-------------------|
| Power | 15W/M 4.6W/ft | ● 2200K | 980lm/m 299lm/ft |
| Voltage | DC24V | ● 2500K | 1050lm/m 320lm/ft |
| CRI | 90 | ● 2700K | 1070lm/m 326lm/ft |
| Led Qty | 240LEDs/M 73LEDs/ft | ● 3000K | 1170lm/m 357lm/ft |
| Length/Reel | 5M 16.41ft | ● 4000K | 1260lm/m 384lm/ft |
| Cutting Length | 25mm 0.98" | ● 5000K | 1240lm/m 378lm/ft |
| Waterproof grade | IP20/IP62/IP65/IP67/IP68 | ● 6000K | 1200lm/m 366lm/ft |

Note: 'x' (CCT) = "27"(2700K) / "30"(3000K) / "40"(4000K) / "50"(5000K) / "60"(6000K), Please contact us for more information.
* Please contact our sales for the latest details and certifications

Dimension

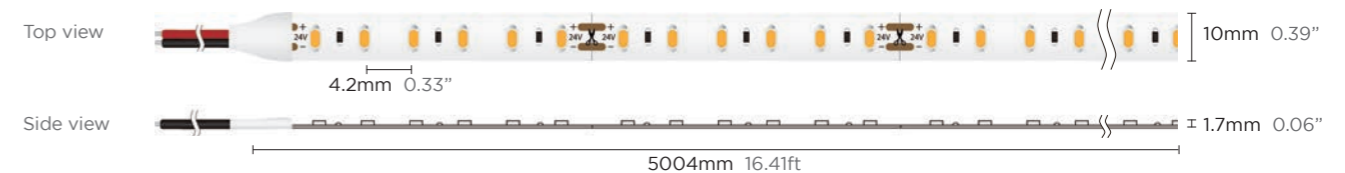

Connectors List

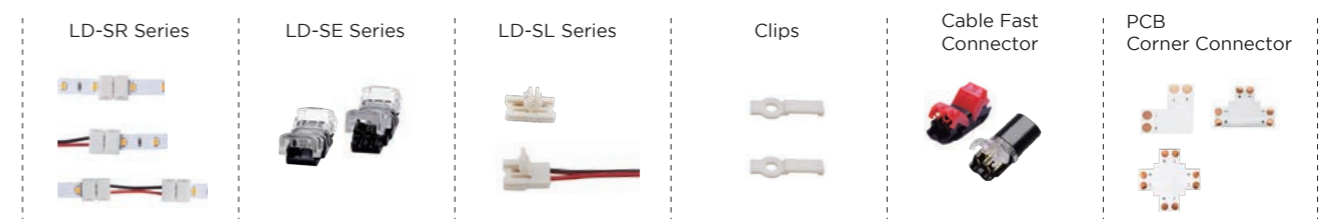

* Please Go to page 248 for Accessory and Connector Usage Guidelines.

300LEDs/M 18W

6LEDs/Group

Product NO. AUPS18WW-24VCLM-300L-2110



Small size 2110, strong bracket, bending resistant.
High Density, combines AL profile and PC cover to create dot-free light.



Waterproof grade

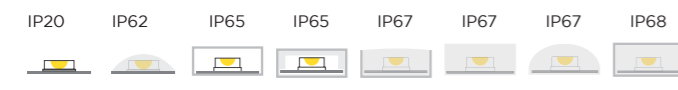

Technical Details

| Technical Details | | Lumens | |
|-------------------------|--------------------------|---------|-------------------|
| Power | 18W/M 5.49W/ft | ● 2200K | 1170lm/m 357lm/ft |
| Voltage | DC24V | ● 2500K | 1270lm/m 387lm/ft |
| CRI | 90 | ● 2700K | 1340lm/m 409lm/ft |
| Led Qty | 300LEDs/M 91LEDs/ft | ● 3000K | 1460lm/m 445lm/ft |
| Length/Reel | 5M 16.41ft | ● 4000K | 1540lm/m 470lm/ft |
| Cutting Length | 20mm 0.79" | ● 5000K | 1500lm/m 457lm/ft |
| Waterproof grade | IP20/IP62/IP65/IP67/IP68 | ● 6000K | 1490lm/m 454lm/ft |

Note: 'x' (CCT) = "27"(2700K) / "30"(3000K) / "40"(4000K) / "50"(5000K) / "60"(6000K), Please contact us for more information.
* Please contact our sales for the latest details and certifications

Dimension

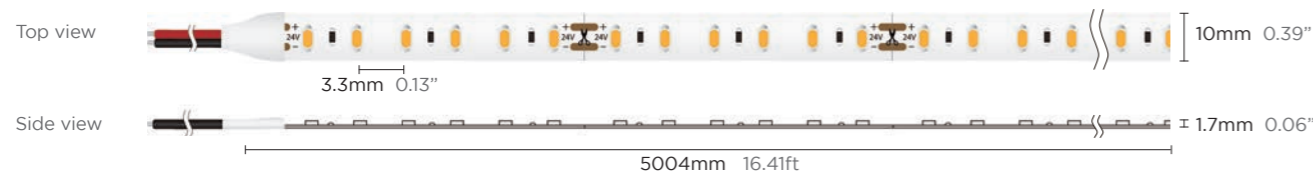

Connectors List



* Please Go to page 248 for Accessory and Connector Usage Guidelines.

280LEDs/M 18W

7LEDs/Group

Product NO. AUPS18WW-24VCLM-280L-2110



Small size 2110, strong bracket, bending resistant.
High Density, combines AL profile and PC cover to create dot-free light.



Waterproof grade

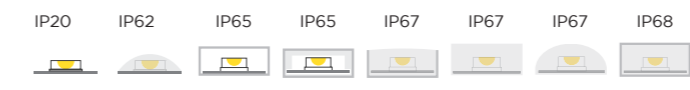

Technical Details

| Technical Details | | Lumens | |
|-------------------------|--------------------------|---------|-------------------|
| Power | 18W/M 5.49W/ft | ● 2200K | 1390lm/m 424lm/ft |
| Voltage | DC24V | ● 2500K | 1435lm/m 438lm/ft |
| CRI | 90 | ● 2700K | 1555lm/m 474lm/ft |
| Led Qty | 280LEDs/M 85LEDs/ft | ● 3000K | 1608lm/m 490lm/ft |
| Length/Reel | 5M 16.41ft | ● 4000K | 1661lm/m 506lm/ft |
| Cutting Length | 25mm 0.98" | ● 5000K | 1635lm/m 498lm/ft |
| Waterproof grade | IP20/IP62/IP65/IP67/IP68 | ● 6000K | 1635lm/m 498lm/ft |

Note: 'x' (CCT) = "27"(2700K) / "30"(3000K) / "40"(4000K) / "50"(5000K) / "60"(6000K), Please contact us for more information.
* Please contact our sales for the latest details and certifications

Dimension

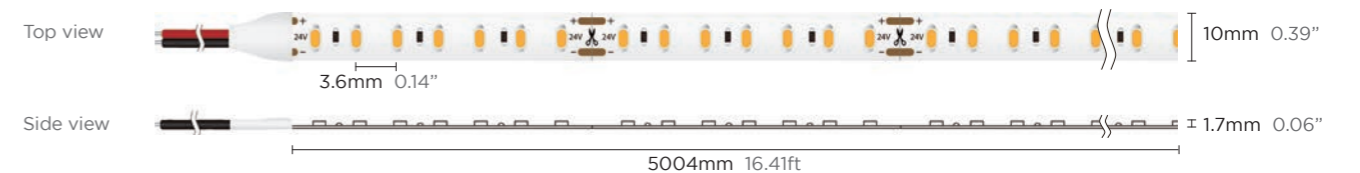

Connectors List

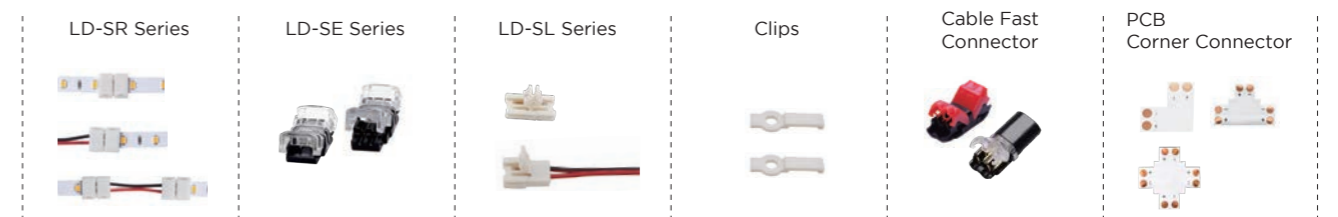

* Please Go to page 248 for Accessory and Connector Usage Guidelines.

700LEDs/M 18W

7LEDs/Group

Product NO. AUPS18WW-24VCLM-700L-2110



Small size 2110, strong bracket, bending resistant.
High Density, combines AL profile and PC cover to create dot-free light.



Waterproof grade

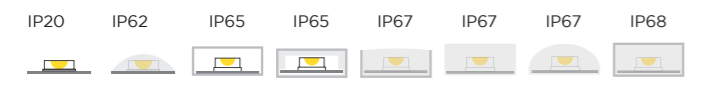

Technical Details

| Technical Details | | Lumens | | |
|-------------------|--------------------------|----------|----------|-------|
| | | 2200K | 2500K | 2700K |
| Power | 18W/M 5.49W/ft | 1619lm/m | 494lm/ft | |
| Voltage | DC24V | 1665lm/m | 508lm/ft | |
| CRI | 90 | 1804lm/m | 550lm/ft | |
| Led Qty | 700LEDs/M 213LEDs/ft | 1865lm/m | 569lm/ft | |
| Length/Reel | 5M 16.41ft | 1927lm/m | 588lm/ft | |
| Cutting Length | 10mm 0.39" | 1896lm/m | 578lm/ft | |
| Waterproof grade | IP20/IP62/IP65/IP67/IP68 | 1896lm/m | 578lm/ft | |

Note: 'x' (CCT) = "27"(2700K) / "30"(3000K) / "40"(4000K) / "50"(5000K) / "60"(6000K), Please contact us for more information.
* Please contact our sales for the latest details and certifications

Dimension

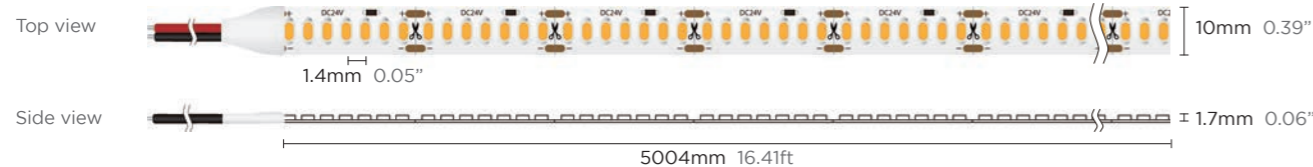

Connectors List



* Please Go to page 248 for Accessory and Connector Usage Guidelines.

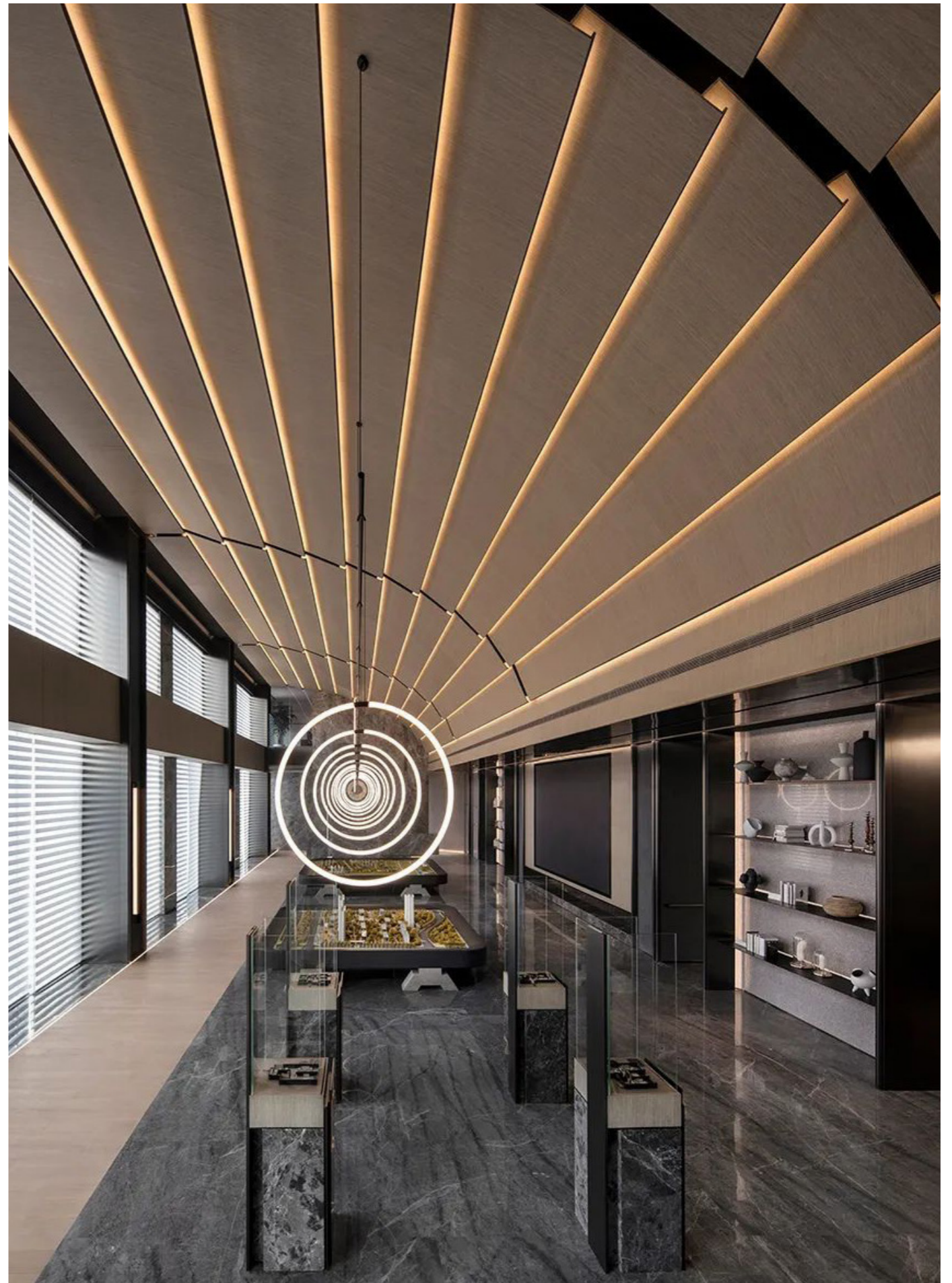

Colorful Series

The atmosphere is inseparable from colors.
Provides better options for various venues.
Indirect installation of linear lighting also makes the environment more concise
and can better reflect the atmosphere of the environment.



Tunable White / 5050 SMD

60LEDS/M 14.4W

Product NO. AUPS14WW-24VCLM-60L-5050-3Y



Can meet different color temperature requirements. Integrated package solution for more uniform and consistent light mixing. The matched color control system can achieve uniform color temperature and brightness adjustment.

2700K + 6000K



Waterproof grade



Technical Details

| | |
|-------------------|-------------------------------|
| Power | 14.4W/M 4.39W/ft |
| Voltage | DC24V |
| CRI | 80 |
| Led Qty | 60LEDS/M 18LEDS/ft |
| Color Temperature | ● 2700K ○ 6000K |
| Lumens | 640lm 195lm/ft 680lm 207lm/ft |
| Length/Reel | 5M 16.41ft |
| Cutting Length | 100mm 3.94" |
| Waterproof grade | IP20/IP62/IP65/IP67/IP68 |

Note: 'x' (CCT) = "27"(2700K) / "30"(3000K) / "40"(4000K) / "50"(5000K) / "60"(6000K), Please contact us for more information.
* Please contact our sales for the latest details and certifications

Dimension

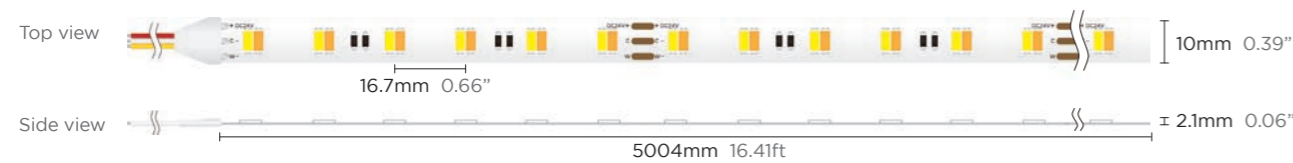

Connectors List



* Please Go to page 248 for Accessory and Connector Usage Guidelines.

Tunable White / 5050 SMD

60LEDS/M 14.4W

Product NO. AUPS14WW-24VCLM-60L-5050-5Y



Can meet different color temperature requirements. The matched color control system can achieve uniform color temperature and brightness adjustment.

2700K + 6000K



Waterproof grade



Technical Details

| | |
|-------------------|-------------------------------|
| Power | 14.4W/M 4.39W/ft |
| Voltage | DC24V |
| CRI | 90 |
| Led Qty | 60LEDS/M 18LEDS/ft |
| Color Temperature | ● 2700K ○ 6000K |
| Lumens | 620lm 189lm/ft 660lm 201lm/ft |
| Length/Reel | 5M 16.41ft |
| Cutting Length | 66.7mm 2.63" |
| Waterproof grade | IP20/IP62/IP65/IP67/IP68 |

Note: 'x' (CCT) = "27"(2700K) / "30"(3000K) / "40"(4000K) / "50"(5000K) / "60"(6000K), Please contact us for more information.
* Please contact our sales for the latest details and certifications

Dimension

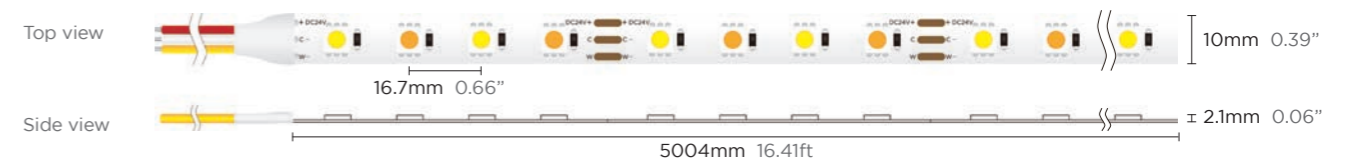

Connectors List



* Please Go to page 248 for Accessory and Connector Usage Guidelines.

Tunable White / 3527 SMD

120LEDS/M 19.2W

Product NO. AUPS19WW-24VCLM-120L-3527-3Y



Can meet different color temperature requirements. Integrated package solution for more uniform and consistent light mixing. The matched color control system can achieve uniform color temperature and brightness adjustment.

2700K + 6000K

Waterproof grade



Technical Details

| | |
|-------------------|-------------------------------|
| Power | 19.2W/M 5.85W/ft |
| Voltage | DC24V |
| CRI | 80 |
| Led Qty | 120LEDS/M 36LEDS/ft |
| Color Temperature | ● 2700K ○ 6000K |
| Lumens | 760lm 232lm/ft 800lm 244lm/ft |
| Length/Reel | 5M 16.41ft |
| Cutting Length | 50mm 1.97" |
| Waterproof grade | IP20/IP62/IP65/IP67/IP68 |

Note: 'x' (CCT) = "27"(2700K) / "30"(3000K) / "40"(4000K) / "50"(5000K) / "60"(6000K), Please contact us for more information.
* Please contact our sales for the latest details and certifications

Dimension

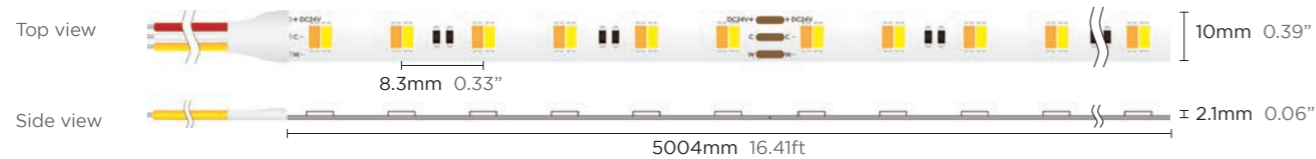

Connectors List



* Please Go to page 248 for Accessory and Connector Usage Guidelines.

Tunable White / 2835 SMD

120LEDS/M 19.2W

Product NO. AUPS19WW-24VCLM-120L-2835-5Y



Can meet different color temperature requirements. The matched color control system can achieve uniform color temperature and brightness adjustment.

2700K + 6000K

Waterproof grade



Technical Details

| | |
|-------------------|-------------------------------|
| Power | 19.2W/M 5.85W/ft |
| Voltage | DC24V |
| CRI | 90 |
| Led Qty | 120LEDS/M 36LEDS/ft |
| Color Temperature | ● 2700K ○ 6000K |
| Lumens | 880lm 268lm/ft 960lm 293lm/ft |
| Length/Reel | 5M 16.41ft |
| Cutting Length | 100mm 3.94" |
| Waterproof grade | IP20/IP62/IP65/IP67/IP68 |

Note: 'x' (CCT) = "27"(2700K) / "30"(3000K) / "40"(4000K) / "50"(5000K) / "60"(6000K), Please contact us for more information.
* Please contact our sales for the latest details and certifications

Dimension

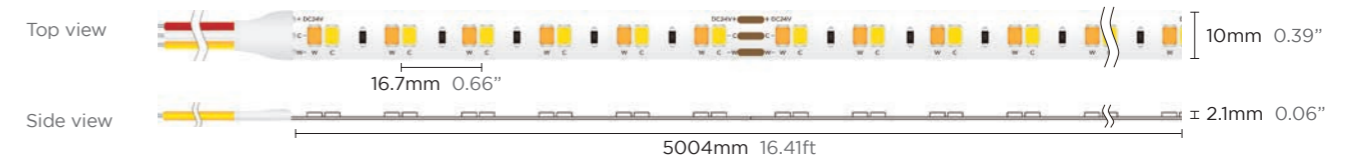

Connectors List



* Please Go to page 248 for Accessory and Connector Usage Guidelines.

RGB / 3838 SMD

120LEDS/M 9.6W

Product NO. AUPS09WR-24VCLM-120L-3838-3Y



Integrated RGB three-color light-emitting chip, bright and pure color.
High density layout, uniform light mixing effect.
5mm width PCB, available for slim space.



Waterproof grade

IP20 IP62 IP65 IP65 IP68



Technical Details

| | |
|--------------------------|--|
| Power | 9.6W/M 2.93W/ft |
| Voltage | DC24V |
| CRI | - |
| Led Qty | 120LEDs/M 36LEDs/ft |
| Color Temperature | ● R ● G ● B |
| Lumens | 615-625nm 84lm/m 26lm/ft 520-530nm 384lm/m 117lm/ft 460-470nm 76lm/m 23lm/ft |
| Length/Reel | 2504mm 8.22ft |
| Cutting Length | 50mm 1.97" |
| Waterproof grade | IP20/IP65 |

Note:'x' (CCT) = "27"(2700K) / "30"(3000K) / "40"(4000K) / "50"(5000K) / "60"(6000K), Please contact us for more information.

* Please contact our sales for the latest details and certifications

Dimension

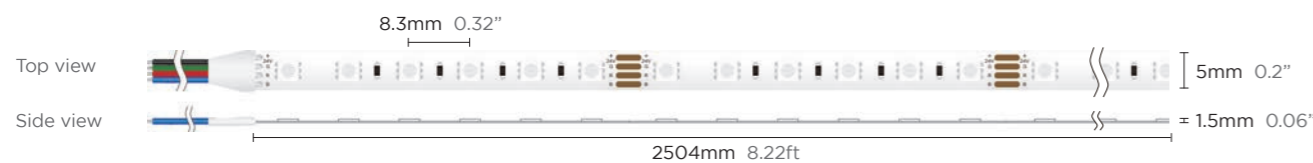

Connectors List



* Please Go to page 248 for Accessory and Connector Usage Guidelines.

RGB / 3838 SMD

120LEDS/M 14.4W

Product NO. AUPS14WR-24VCLM-120L-3838-3Y



Integrated RGB three-color light-emitting chip, bright and pure color.
High density layout, uniform light mixing effect.
Adapt all kinds of controllers for colorful light.



Waterproof grade

IP20 IP62 IP65 IP65 IP68



Technical Details

| | |
|--------------------------|---|
| Power | 14.4W/M 4.39W/ft |
| Voltage | DC24V |
| CRI | - |
| Led Qty | 120LEDs/M 36LEDs/ft |
| Color Temperature | ● R ● G ● B |
| Lumens | 615-625nm 120lm/m 37lm/ft 520-530nm 475lm/m 145lm/ft 460-470nm 98lm/m 30lm/ft |
| Length/Reel | 5M 16.41ft |
| Cutting Length | 50mm 1.97" |
| Waterproof grade | IP20/IP62/IP65/IP67/IP68 |

Note:'x' (CCT) = "27"(2700K) / "30"(3000K) / "40"(4000K) / "50"(5000K) / "60"(6000K), Please contact us for more information.

* Please contact our sales for the latest details and certifications

Dimension

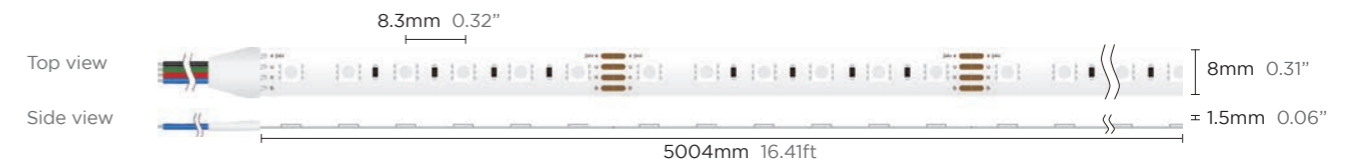

Connectors List



* Please Go to page 248 for Accessory and Connector Usage Guidelines.

RGB / 3838 SMD

144LEDS/M 14.4W

Product NO. AUPS14WR-24VCLM-144L-3838-3Y



High density layout 144 Leds/m, uniform light mixing effect, dot-free light.

Adapt all kinds of controllers for colorful light.



Waterproof grade

IP20 IP62 IP65 IP65 IP68



Technical Details

| | |
|--------------------------|--|
| Power | 14.4W/M 4.39W/ft |
| Voltage | DC24V |
| CRI | - |
| Led Qty | 144LEDS/M 44LEDS/ft |
| Color Temperature | ● R ● G ● B |
| Lumens | 615-625nm 124lm/m 38lm/ft 520-530nm 512lm/m 156lm/ft 460-470nm 103lm/m 31lm/ft |
| Length/Reel | 5M 16.41ft |
| Cutting Length | 41.7mm 1.64" |
| Waterproof grade | IP20/IP62/IP65/IP67/IP68 |

Note:'x' (CCT) =27*(2700K) / *30*(3000K) / *40*(4000K) / *50*(5000K) / *60*(6000K), Please contact us for more information.

* Please contact our sales for the latest details and certifications

Dimension

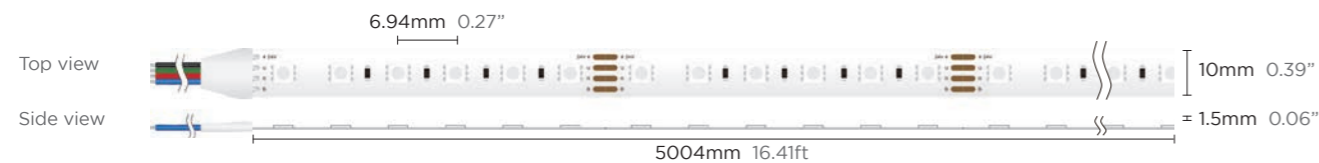

Connectors List



* Please Go to page 248 for Accessory and Connector Usage Guidelines.

RGB / 5050 SMD

30LEDS/M 7.2W

Product NO. AUPS07WR-24VCLM-120L-5050-5Y



Self-packing RGB, with high consistency of wavelength, bright and pure color.

The overall color jump and gradient can be realized by the controlled.



Waterproof grade

IP20 IP62 IP65 IP65 IP68



Technical Details

| | |
|--------------------------|---|
| Power | 7.2W/M 2.19W/ft |
| Voltage | DC24V |
| CRI | - |
| Led Qty | 30LEDS/M 9LEDS/ft |
| Color Temperature | ● R ● G ● B |
| Lumens | 615-625nm 60lm/m 18lm/ft 520-530nm 150lm/m 45lm/ft 460-470nm 40lm/m 12lm/ft |
| Length/Reel | 5M 16.41ft |
| Cutting Length | 166.7mm 6.56" |
| Waterproof grade | IP20/IP62/IP65/IP67/IP68 |

Note:'x' (CCT) =27*(2700K) / *30*(3000K) / *40*(4000K) / *50*(5000K) / *60*(6000K), Please contact us for more information.

* Please contact our sales for the latest details and certifications

Dimension

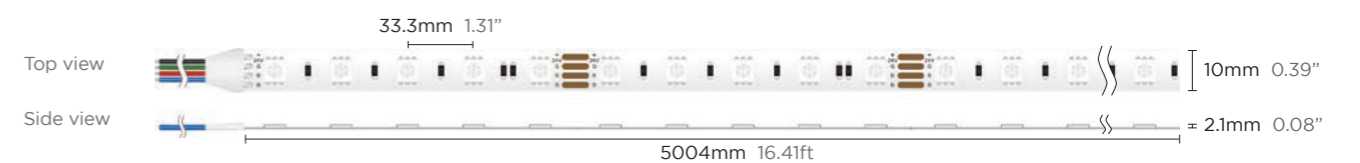

Connectors List



* Please Go to page 248 for Accessory and Connector Usage Guidelines.

RGB / 5050SMD

60LEDS/M 14.4W

Product NO. AUPS14WR-24VCLM-60L-5050-5Y



Self-packing RGB, with high consistency of wavelength, bright and pure color. The overall color jump and gradient can be realized by the controlled.



Waterproof grade



Technical Details

| | | | | | | |
|--------------------------|--------------------------|--|------------------|--|----------------|--|
| Power | 14.4W/M 4.39W/ft | | | | | |
| Voltage | DC24V | | | | | |
| CRI | - | | | | | |
| Led Qty | 60LEDS/M 18LEDS/ft | | | | | |
| Color Temperature | ●R | | ●G | | ●B | |
| Lumens | 130lm/m 40lm/ft | | 330lm/m 101lm/ft | | 70lm/m 21lm/ft | |
| Length/Reel | 5M 16.41ft | | | | | |
| Cutting Length | 100mm 3.94" | | | | | |
| Waterproof grade | IP20/IP62/IP65/IP67/IP68 | | | | | |

Note:'x' (CCT) =27"(2700K) / "30"(3000K) / "40"(4000K) / "50"(5000K) / "60"(6000K), Please contact us for more information.

* Please contact our sales for the latest details and certifications

Dimension

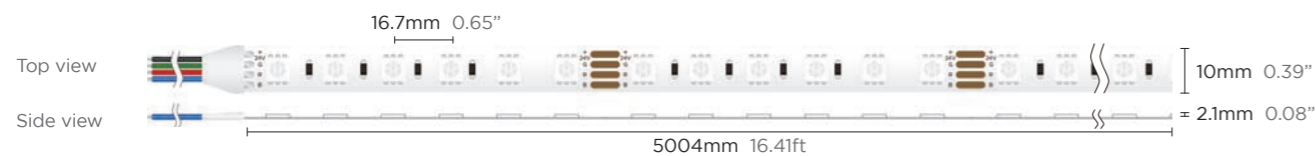

Connectors List



* Please Go to page 248 for Accessory and Connector Usage Guidelines.

2835 SMD / RGB

70LEDS/M 7.2W

Product NO. AUPS07WR-24VCLM-70L-2835-5Y



High-quality 2835 LED beads are used, with low power consumption and high brightness. The light is evenly distributed and cost-effective. Paired with connectors and profiles, installation is quick and easy, creating more scene applications.



Waterproof grade

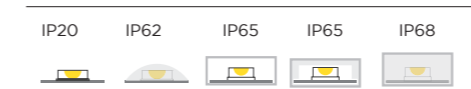

Technical Details

| | | | | | | |
|--------------------------|--------------------------|--|---------------------------|--|--------------------------|--|
| Power | 7.2W/M 2.19W/ft | | | | | |
| Voltage | DC24V | | | | | |
| CRI | - | | | | | |
| Led Qty | 70LEDS/M 9LEDS/ft | | | | | |
| Color Temperature | ●R | | ●G | | ●B | |
| Lumens | 615-625nm 85lm/m 26lm/ft | | 520-530nm 235lm/m 72lm/ft | | 460-470nm 45lm/m 14lm/ft | |
| Length/Reel | 5M 16.41ft | | | | | |
| Cutting Length | 100mm 3.94" | | | | | |
| Waterproof grade | IP20/IP62/IP65/IP67/IP68 | | | | | |

Note:'x' (CCT) =27"(2700K) / "30"(3000K) / "40"(4000K) / "50"(5000K) / "60"(6000K), Please contact us for more information.

* Please contact our sales for the latest details and certifications

Dimension

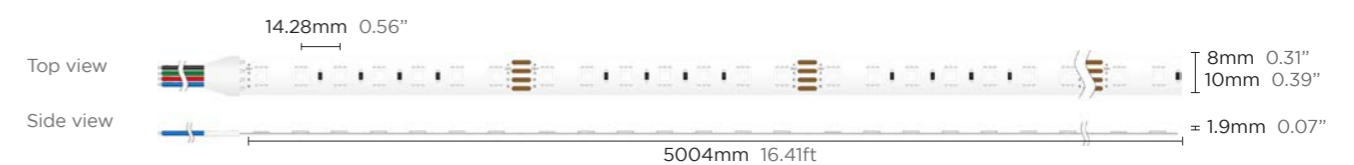

Connectors List



* Please Go to page 248 for Accessory and Connector Usage Guidelines.

2835 SMD / RGB

140LEDS/M 12W

Product NO. AUPS12WR-24VCLM-140L-2835-5Y



Self-packing RGB, with high consistency of wavelength, bright and pure color.
The overall color jump and gradient can be realized by the controlled.



Waterproof grade

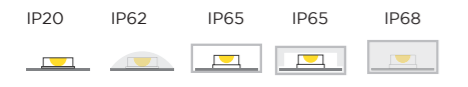

Technical Details

| | |
|--------------------------|---|
| Power | 12W/M 3.66W/ft |
| Voltage | DC24V |
| CRI | - |
| Led Qty | 140LEDS/M 42LEDS/ft |
| Color Temperature | ●R ●G ●B |
| Lumens | 615-625nm 135lm/m 41lm/ft 520-530nm 440lm/m 134lm/ft 460-470nm 88lm/m 27lm/ft |
| Length/Reel | 5M 16.41ft |
| Cutting Length | 50mm 1.97" |
| Waterproof grade | IP20/IP62/IP65/IP67/IP68 |

Note:'x' (CCT) =27°(2700K) / 30°(3000K) / 40°(4000K) / 50°(5000K) / 60°(6000K), Please contact us for more information.

* Please contact our sales for the latest details and certifications

Dimension

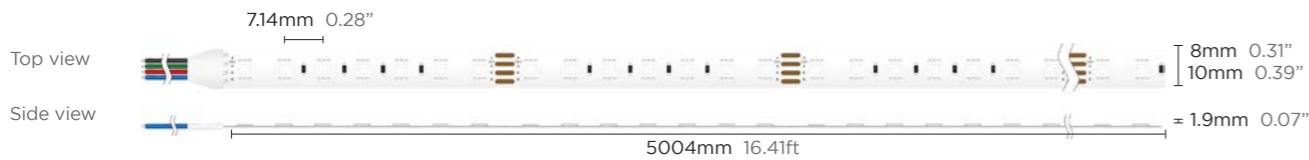

Connectors List



* Please Go to page 248 for Accessory and Connector Usage Guidelines.

2835 SMD / RGB

182LEDS/M 15W

Product NO. AUPS15WR-24VCLM-182L-2835-5Y



High-quality 2835 LED beads are used, with low power consumption and high brightness.
The light is evenly distributed and cost-effective.
Paired with connectors and profiles, installation is quick and easy, creating more scene applications.



Waterproof grade



Technical Details

| | |
|--------------------------|--|
| Power | 15W/M 4.57W/ft |
| Voltage | DC24V |
| CRI | - |
| Led Qty | 182LEDS/M 55LEDS/ft |
| Color Temperature | ●R ●G ●B |
| Lumens | 615-625nm 160lm/m 49lm/ft 520-530nm 630lm/m 192lm/ft 460-470nm 115lm/m 35lm/ft |
| Length/Reel | 5M 16.41ft |
| Cutting Length | 38.5mm 1.52" |
| Waterproof grade | IP20/IP62/IP65/IP67/IP68 |

Note:'x' (CCT) =27°(2700K) / 30°(3000K) / 40°(4000K) / 50°(5000K) / 60°(6000K), Please contact us for more information.

* Please contact our sales for the latest details and certifications

Dimension

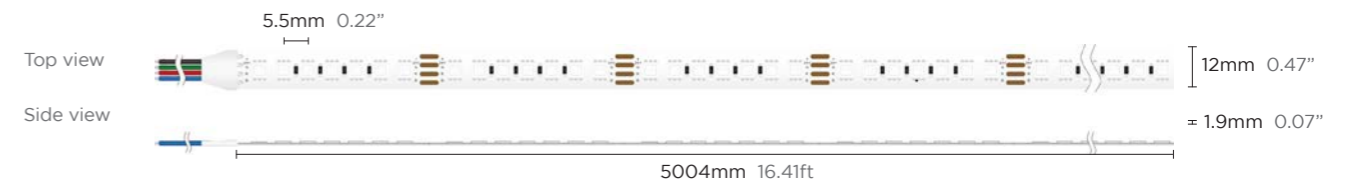

Connectors List



* Please Go to page 248 for Accessory and Connector Usage Guidelines.

Multiple Color / RGBW / 3527 SMD

120LEDS/M 19.2W

Product NO. AUMC19WR-24VCLM-120L-3527



Can achieve a variety of colors including white ,and improve color index and consistency for white lights. Integrated package solution for more uniform and consistent light mixing.



Waterproof grade



Technical Details

| | |
|-------------------------|--------------------------|
| Power | 19.2W/M 5.85W/ft |
| Voltage | DC24V |
| CRI | 80 |
| Led Qty | 120LEDS/M 36LEDS/ft |
| Length/Reel | 5M 16.41ft |
| Cutting Length | 100mm 3.94" |
| Waterproof grade | IP20/IP62/IP65/IP67/IP68 |

Lumens

| Color Temperature | | | |
|-------------------|-----------|---------|----------|
| ● Red | 615-625nm | 130lm/m | 40lm/ft |
| ● Green | 520-530nm | 330lm/m | 30lm/ft |
| ● Blue | 460-470nm | 70lm/m | 32lm/ft |
| ○ White | | | |
| ● 2400K | | 310lm/m | 95lm/ft |
| ● 2700K | | 320lm/m | 98lm/ft |
| ● 3000K | | 340lm/m | 104lm/ft |
| ● 4000K | | 360lm/m | 110lm/ft |
| ● 5000K | | 400lm/m | 122lm/ft |
| ● 6000K | | 380lm/m | 116lm/ft |

Note:'x' (CCT) = "27"(2700K) / "30"(3000K) / "40"(4000K) / "50"(5000K) / "60"(6000K), Please contact us for more information.

* Please contact our sales for the latest details and certifications

Dimension

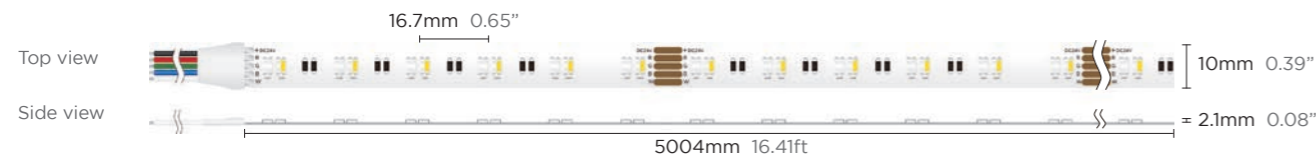

Connectors List



* Please Go to page 248 for Accessory and Connector Usage Guidelines.

Multiple Color / RGBW / 5050 SMD

60LEDS/M 14.4W

Product NO. AUMC14WR-24VCLM-60L-5050



Can achieve a variety of colors including white ,and improve color index and consistency for white lights. Integrated package solution for more uniform and consistent light mixing.



Waterproof grade

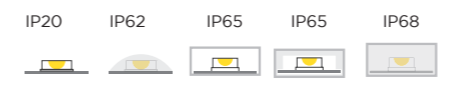

Technical Details

| | |
|-------------------------|--------------------------|
| Power | 14.4W/M 4.39W/ft |
| Voltage | DC24V |
| CRI | 90 |
| Led Qty | 60LEDS/M 18LEDS/ft |
| Length/Reel | 5M 16.41ft |
| Cutting Length | 200mm 7.87" |
| Waterproof grade | IP20/IP62/IP65/IP67/IP68 |

Lumens

| Color Temperature | | |
|-------------------|---------|----------|
| ● Red | 70lm/m | 21lm/ft |
| ● Green | 160lm/m | 49lm/ft |
| ● Blue | 40lm/m | 12lm/ft |
| ○ White | | |
| ● 2400K | 540lm/m | 165lm/ft |
| ● 2700K | 620lm/m | 189lm/ft |
| ● 3000K | 630lm/m | 192lm/ft |
| ● 4000K | 710lm/m | 216lm/ft |
| ● 5000K | 710lm/m | 216lm/ft |
| ● 6000K | 660lm/m | 201lm/ft |

Note:'x' (CCT) = "27"(2700K) / "30"(3000K) / "40"(4000K) / "50"(5000K) / "60"(6000K), Please contact us for more information.

* Please contact our sales for the latest details and certifications

Dimension



Connectors List



* Please Go to page 248 for Accessory and Connector Usage Guidelines.

Multiple Color / RGBW / 5050 SMD

60LEDs/M 19.2W

Product NO. AUMC19WRW-24VCLM-60L-5050



Can meet the requirements of a variety of the white and color light, and improve the color index and consistency for white lights. 4 in 1 integrated package solution could achieve more uniform and consistent mixing light.



Waterproof grade



Technical Details

| | |
|-------------------------|--------------------------|
| Power | 19.2W/M 5.85W/ft |
| Voltage | DC24V |
| CRI | 80 |
| Led Qty | 60LEDs/M 18LEDs/ft |
| Length/Reel | 5M 16.41ft |
| Cutting Length | 100mm 3.94" |
| Waterproof grade | IP20/IP62/IP65/IP67/IP68 |

Lumens

| Color Temperature | | |
|-------------------|---------|----------|
| ● Red | 120lm/m | 37lm/ft |
| ● Green | 300lm/m | 91lm/ft |
| ● Blue | 60lm/m | 18lm/ft |
| ○ White | | |
| ● 2400K | 300lm/m | 91lm/ft |
| ● 2700K | 310lm/m | 95lm/ft |
| ● 3000K | 330lm/m | 101lm/ft |
| ● 4000K | 340lm/m | 104lm/ft |
| ● 5000K | 380lm/m | 116lm/ft |
| ● 6000K | 360lm/m | 110lm/ft |

Note: 'x' (CCT) = "27"(2700K) / "30"(3000K) / "40"(4000K) / "50"(5000K) / "60"(6000K), Please contact us for more information.
* Please contact our sales for the latest details and certifications

Dimension

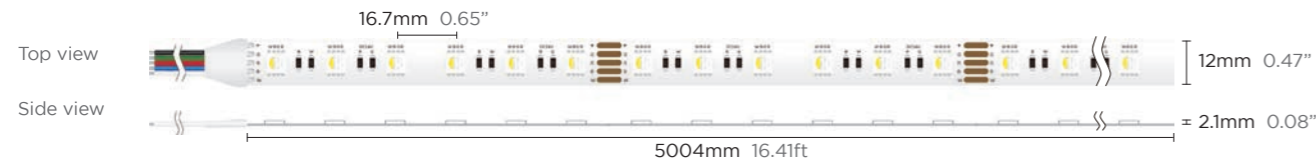

Connectors List



* Please Go to page 248 for Accessory and Connector Usage Guidelines.

Multiple Color / RGBW / 2835&2216 SMD

60LEDs/M 19.2W

Product NO. AUMC19WRW-24VCLM-60L-28352216



Can meet the requirements of a variety of the white and color light, and improve the color index and consistency for white lights. 4 in 1 integrated package solution could achieve more uniform and consistent mixing light.



Waterproof grade

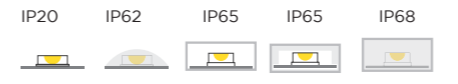

Technical Details

| | |
|-------------------------|--------------------------|
| Power | 15W/M 4.57W/ft |
| Voltage | DC24V |
| CRI | 90 |
| Led Qty | 224LEDs/M 68LEDs/ft |
| Length/Reel | 5M 16.41ft |
| Cutting Length | 62.5mm 2.46" |
| Waterproof grade | IP20/IP62/IP65/IP67/IP68 |

Lumens

| Color Temperature | | |
|-------------------|---------|----------|
| ● Red | 120lm/m | 37lm/ft |
| ● Green | 300lm/m | 91lm/ft |
| ● Blue | 60lm/m | 18lm/ft |
| ● 4000K | 340lm/m | 104lm/ft |

Note: 'x' (CCT) = "27"(2700K) / "30"(3000K) / "40"(4000K) / "50"(5000K) / "60"(6000K), Please contact us for more information.
* Please contact our sales for the latest details and certifications

Dimension

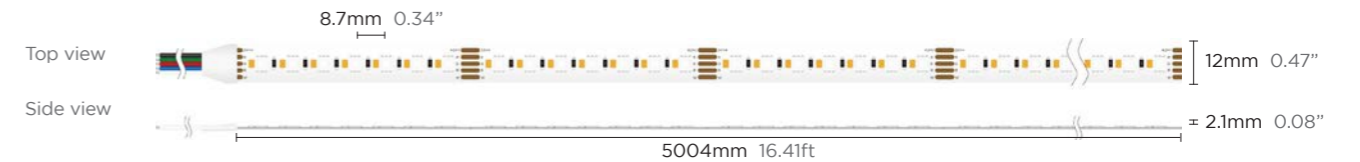

Connectors List



* Please Go to page 248 for Accessory and Connector Usage Guidelines.

Multiple Color / RGBWW / 2835&2216 SMD

60LEDS/M 24W

Product NO. AUMC24WRW-24VCLM-60L-28352216



Can meet the requirements of a variety of the white and color light, and improve the color index and consistency for white lights. 5 in 1 integrated package solution could achieve more uniform and consistent mixing light.



Waterproof grade



Technical Details

| | |
|-------------------------|--------------------------|
| Power | 15W/M 4.57W/ft |
| Voltage | DC24V |
| CRI | 90 |
| Led Qty | 210LEDs/M 64LEDs/ft |
| Length/Reel | 5M 16.41ft |
| Cutting Length | 100mm 3.94" |
| Waterproof grade | IP20/IP62/IP65/IP67/IP68 |

Lumens

| Color Temperature | | |
|-------------------|---------|----------|
| ● Red | 100lm/m | 30lm/ft |
| ● Green | 300lm/m | 91lm/ft |
| ● Blue | 60lm/m | 18lm/ft |
| ○ White | | |
| ● 2400K | 340lm/m | 104lm/ft |
| ● 6000K | 360lm/m | 110lm/ft |

Note: 'x' (CCT) = "27"(2700K) / "30"(3000K) / "40"(4000K) / "50"(5000K) / "60"(6000K), Please contact us for more information.
* Please contact our sales for the latest details and certifications

Dimension

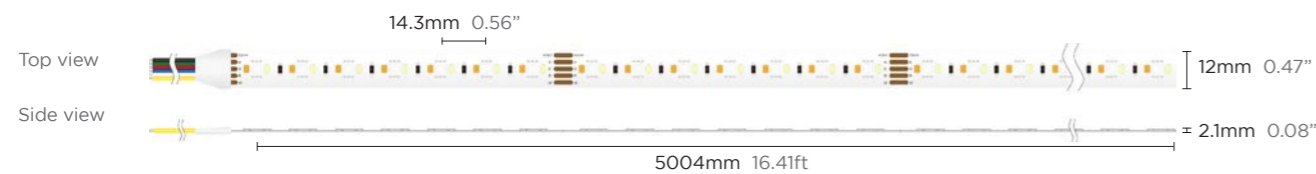

Multiple Color / RGBWW / 5050 SMD

60LEDS/M 24W

Product NO. AUMC24WRW-24VCLM-60L-5050



Can meet the requirements of a variety of the white and color light, and improve the color index and consistency for white lights. 5 in 1 integrated package solution could achieve more uniform and consistent mixing light.



Waterproof grade



Technical Details

| | |
|-------------------------|--------------------------|
| Power | 24W/M 7.32W/ft |
| Voltage | DC24V |
| CRI | 80 |
| Led Qty | 60LEDs/M 18LEDs/ft |
| Length/Reel | 5M 16.41ft |
| Cutting Length | 200mm 7.87" |
| Waterproof grade | IP20/IP62/IP65/IP67/IP68 |

Lumens

| Color Temperature | | |
|-------------------|---------|----------|
| ● Red | 120lm/m | 37lm/ft |
| ● Green | 330lm/m | 101lm/ft |
| ● Blue | 60lm/m | 18lm/ft |
| ○ White | | |
| ● 2400K | 340lm/m | 104lm/ft |
| ● 6000K | 430lm/m | 131lm/ft |

Note: 'x' (CCT) = "27"(2700K) / "30"(3000K) / "40"(4000K) / "50"(5000K) / "60"(6000K), Please contact us for more information.
* Please contact our sales for the latest details and certifications

Dimension

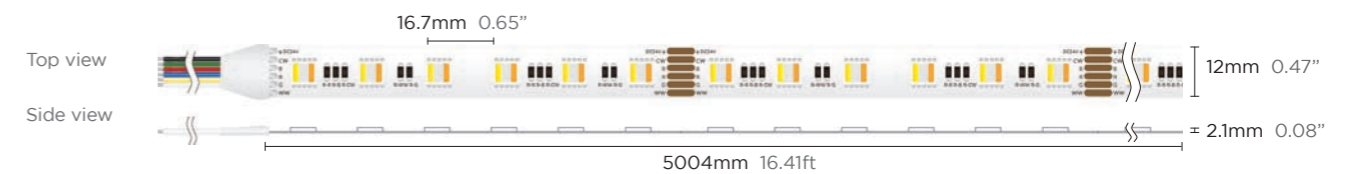

CRI 98+ / 95+ Series



CRI 98+

Lower harmful blue light, good for visual organs. High optical saturation level, Rg>100 to get vivid color. Closer to the natural light spectrum, healthy lighting is preferred.

70LEDs/M 9.6W 24V

Product NO.
AUC09WW-24VCLM-70L-CRI98



Technical Details

| Power | 9.6W/M 2.93W/ft | Lumens | | ErP Class | | | | | | | | |
|-------------------------|--------------------|---------|------------------|-----------|------------------|---------|------------------|---------|------------------|---------|------------------|-----|
| Voltage | DC24V | ● 2700K | 760lm/m 231lm/ft | ● 3000K | 780lm/m 237lm/ft | ● 4000K | 800lm/m 243lm/ft | ● 5000K | 788lm/m 240lm/ft | ● 6000K | 780lm/m 237lm/ft | ▶ G |
| CRI | 98 | | | | | | | | | | | ▶ G |
| Led Qty | 70LEDs/M 21LEDs/ft | | | | | | | | | | | ▶ G |
| Length/Reel | 5004mm 16.41ft | | | | | | | | | | | ▶ G |
| Cutting Length | 100mm 3.93" | | | | | | | | | | | ▶ G |
| Waterproof grade | IP20 | | | | | | | | | | | |

Note: 'x' (CCT) = "27"(2700K) / "30"(3000K) / "40"(4000K) / "50"(5000K) / "60"(6000K), Please contact us for more information.
* Please contact our sales for the latest details and certifications

Dimension

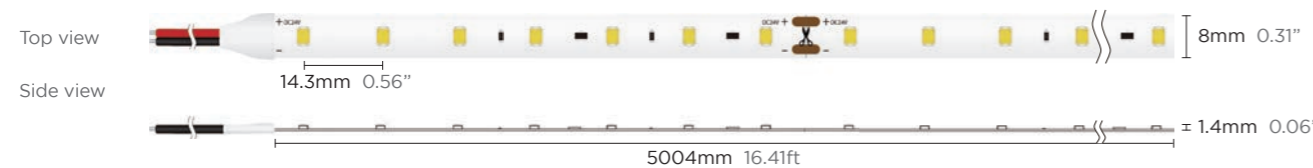

Connectors List

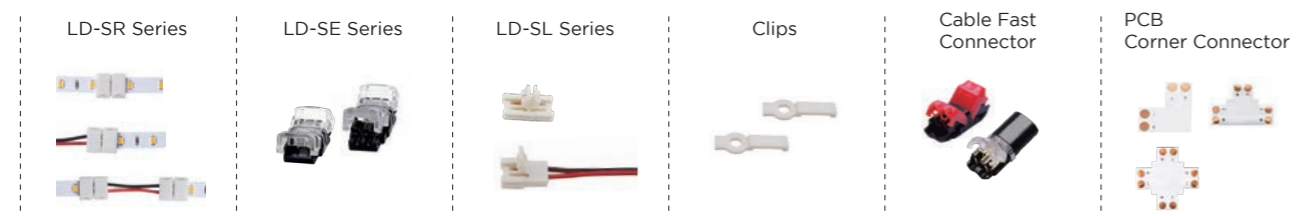

* Please Go to page 248 for Accessory and Connector Usage Guidelines.

140LEDs/M 19.2W 24V

Product NO. AUC19WW-24VCLM-140L-CRI98



Technical Details

| Power | 19.2W/M 5.85W/ft | Lumens | | ErP Class | | | | | | | | |
|-------------------------|---------------------|---------|-------------------|-----------|-------------------|---------|-------------------|---------|-------------------|---------|-------------------|-----|
| Voltage | DC24V | ● 2700K | 1530lm/m 466lm/ft | ● 3000K | 1550lm/m 472lm/ft | ● 4000K | 1620lm/m 493lm/ft | ● 5000K | 1580lm/m 481lm/ft | ● 6000K | 1550lm/m 472lm/ft | ▶ G |
| CRI | 98 | | | | | | | | | | | ▶ G |
| Led Qty | 140LEDs/M 42LEDs/ft | | | | | | | | | | | ▶ G |
| Length/Reel | 5004mm 16.41ft | | | | | | | | | | | ▶ G |
| Cutting Length | 50mm 1.97" | | | | | | | | | | | ▶ G |
| Waterproof grade | IP20 | | | | | | | | | | | |

Note: 'x' (CCT) = "27"(2700K) / "30"(3000K) / "40"(4000K) / "50"(5000K) / "60"(6000K), Please contact us for more information.
* Please contact our sales for the latest details and certifications

Dimension



Connectors List



* Please Go to page 248 for Accessory and Connector Usage Guidelines.

CRI 95+

With the super-high color rendering performance of CRI>95 and the good cost-effective, High fitting with solar spectrum, high color reducibility, the color of irradiated object closer to under natural light. Rf > 95; high color saturation, Rg > 100; lower harmful blue light, healthy lighting.

60LEDs/M 4.8W 24V

Product NO.
AUC04WW-24VCLM-60L-CRI95



Technical Details

| Power | 4.8W/M 1.46W/ft | Lumens | | ErP Class | |
|-------------------------|---------------------------|---------|------------------|-----------|----------|
| Voltage | DC24V | ● 2400K | 360lm/m 110lm/ft | | G |
| CRI | 95 | ● 2700K | 370lm/m 113lm/ft | | G |
| Led Qty | 60LEDs/M 18LEDs/ft | ● 3000K | 384lm/m 117lm/ft | | G |
| Length/Reel | 5004mm 16.41ft | ● 4000K | 394lm/m 120lm/ft | | G |
| Cutting Length | 100mm 3.93" | ● 5000K | 413lm/m 126lm/ft | | |
| Waterproof grade | IP20 / IP62 / IP65 / IP68 | ● 6000K | 384lm/m 117lm/ft | | |

Note:'x' (CCT) = "27"(2700K) / "30"(3000K) / "40"(4000K) / "50"(5000K) / "60"(6000K), Please contact us for more information.

* Please contact our sales for the latest details and certifications

Dimension

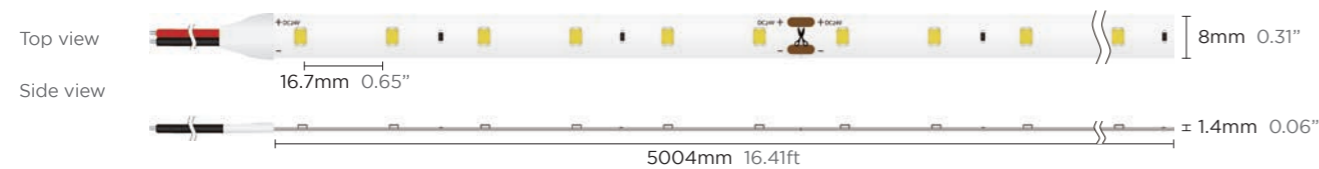

Connectors List



* Please Go to page 248 for Accessory and Connector Usage Guidelines.

LED STRIP SERIES · CRI 95+

60LEDs/M 10W 24V

Product NO. AUC10WW-24VCLM-60L-CRI95



Technical Details

| Power | 10W/M 3.05W/ft | Lumens | | ErP Class | |
|-------------------------|---------------------------|---------|------------------|-----------|----------|
| Voltage | DC24V | ● 2400K | 750lm/m 229lm/ft | | G |
| CRI | 95 | ● 2700K | 770lm/m 235lm/ft | | G |
| Led Qty | 60LEDs/M 18LEDs/ft | ● 3000K | 800lm/m 244lm/ft | | G |
| Length/Reel | 5004mm 16.41ft | ● 4000K | 820lm/m 250lm/ft | | G |
| Cutting Length | 100mm 3.93" | ● 5000K | 860lm/m 262lm/ft | | |
| Waterproof grade | IP20 / IP62 / IP65 / IP68 | ● 6000K | 800lm/m 244lm/ft | | |

Note:'x' (CCT) = "27"(2700K) / "30"(3000K) / "40"(4000K) / "50"(5000K) / "60"(6000K), Please contact us for more information.

* Please contact our sales for the latest details and certifications

Dimension

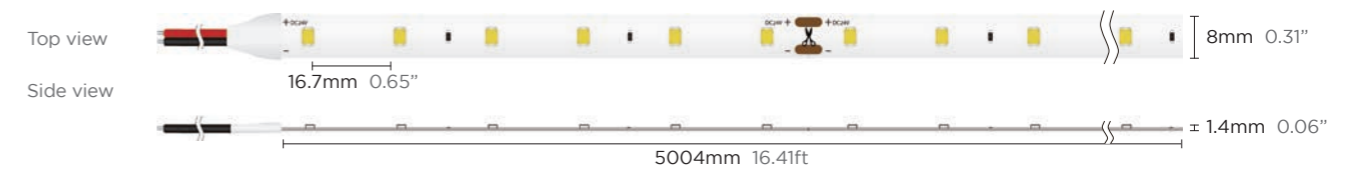

Connectors List



* Please Go to page 248 for Accessory and Connector Usage Guidelines.

LED STRIP SERIES · CRI 95+

120LEDs/M 9.6W 24V

Product NO. AUC09WW-24VCLM-120L-CRI95



Technical Details

| Power | 9.6W/M 2.93W/ft | Lumens | | ErP Class | |
|-------------------------|---------------------------|---------|------------------|-----------|--|
| Voltage | DC24V | ● 2400K | 720lm/m 220lm/ft | G | |
| CRI | 95 | ● 2700K | 739lm/m 225lm/ft | G | |
| Led Qty | 120LEDs/M 36LEDs/ft | ● 3000K | 768lm/m 234lm/ft | G | |
| Length/Reel | 5004mm 16.41ft | ● 4000K | 787lm/m 240lm/ft | G | |
| Cutting Length | 50mm 1.97" | ● 5000K | 785lm/m 239lm/ft | G | |
| Waterproof grade | IP20 / IP62 / IP65 / IP68 | ● 6000K | 768lm/m 234lm/ft | G | |

Note: 'x' (CCT) = "27"(2700K) / "30"(3000K) / "40"(4000K) / "50"(5000K) / "60"(6000K), Please contact us for more information.

* Please contact our sales for the latest details and certifications

Dimension

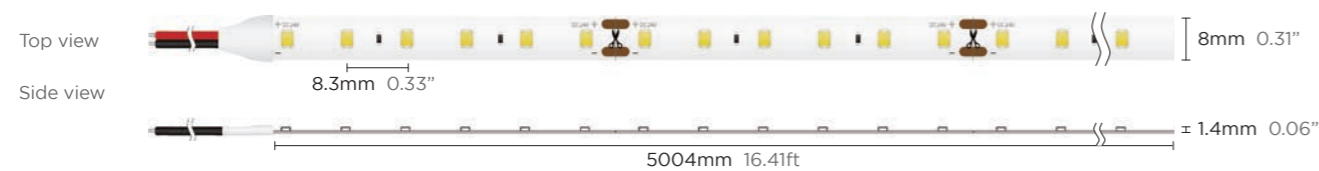

Connectors List



* Please Go to page 248 for Accessory and Connector Usage Guidelines.



DIGITAL COLORFUL

SPI Series

DMX Series

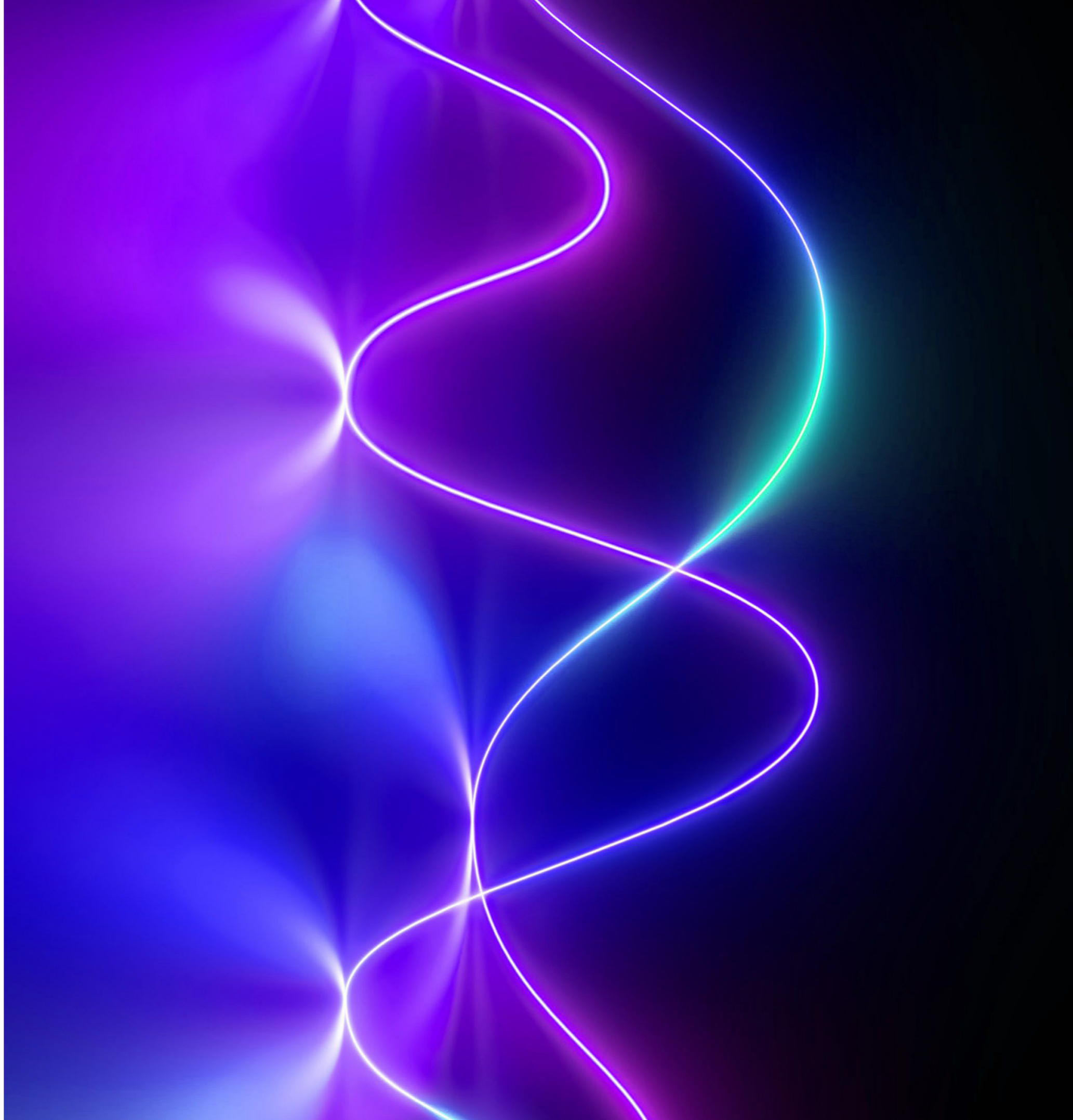

SPI Series

Built-in dot control IC, high consistency and reliability.
 RGBW 4 in 1 diode, present with variety color.
 The matched controller can realize the following effects: single color, gradient color change, chasing, animation and scene display.

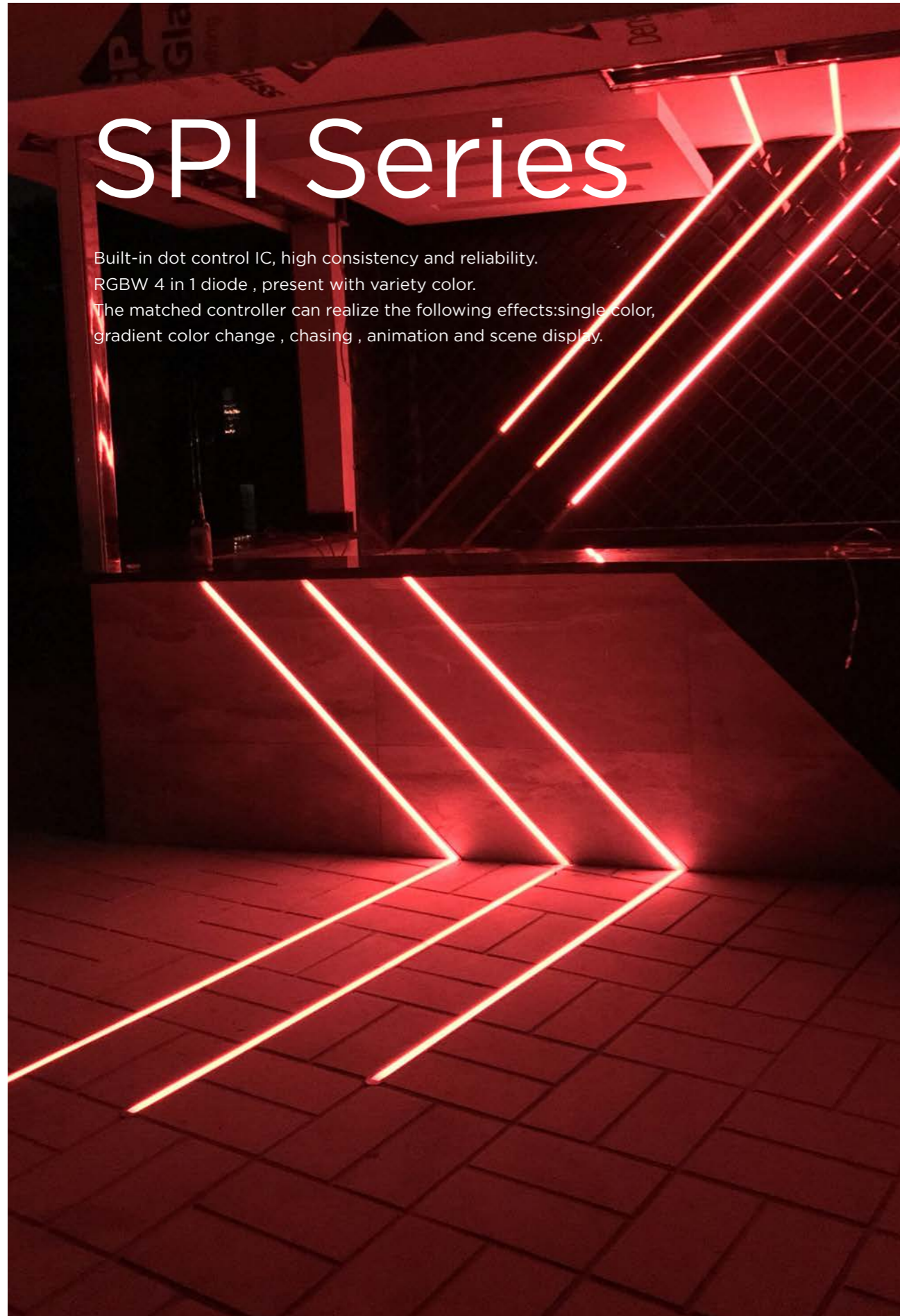

SPI Series / RGBW / 5050SMD / 5V 60LEDS/M 12W

Product NO. AUSPI12WRW-05VCLM-60L



Waterproof grade



Technical Details

| | |
|------------------|---------------------|
| Power | 12W/M 3.66W/ft |
| Voltage | DC5V |
| CRI | 90 |
| Led Qty | 60LEDS/M 18LEDS/ft |
| Length/Reel | 5M 16.41ft |
| Cutting Length | 16.7mm 0.65" |
| Waterproof grade | IP20/IP62/IP65/IP68 |

Note: 'x' (CCT) = *27*(2700K) / *30*(3000K) / *40*(4000K) / *50*(5000K) / *60*(6000K), Please contact us for more information.
 * Please contact our sales for the latest details and certifications

Lumens

| Color Temperature | | |
|-------------------|--------------------|----------|
| ● Red | 615-625nm /120lm/m | 36lm/ft |
| ● Green | 520-530nm /300lm/m | 91lm/ft |
| ● Blue | 460-470nm /70lm/m | 21lm/ft |
| ○ White | | |
| ● 2700K | 300lm/m | 91lm/ft |
| ● 3000K | 310lm/m | 95lm/ft |
| ● 4000K | 320lm/m | 98lm/ft |
| ● 5000K | 340lm/m | 104lm/ft |
| ● 6000K | 360lm/m | 110lm/ft |

Dimension



SPI Series / RGB / 5050SMD / 5V

60LEDS/M 14W

Product NO. AUSPI14WR-05VCLM-60L



Waterproof grade

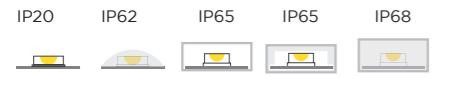

Technical Details

| | |
|-------------------|--|
| Power | 14W/M 4.27W/ft |
| Voltage | DC5V |
| CRI | - |
| Led Qty | 60LEDS/M 18LEDS/ft |
| Color Temperature | ●R ●G ●B |
| Lumens | 615-625nm 120lm/m 36lm/ft 520-530nm 300lm/m 91lm/ft 460-470nm 70lm 21lm/ft |
| Length/Reel | 5M 16.41ft |
| Cutting Length | 16.7mm 0.65" |
| Waterproof grade | IP20/IP62/IP65/IP68 |

Note:'x' (CCT) =*27*(2700K) / *30*(3000K) / *40*(4000K) / *50*(5000K) / *60*(6000K), Please contact us for more information.

* Please contact our sales for the latest details and certifications

Dimension

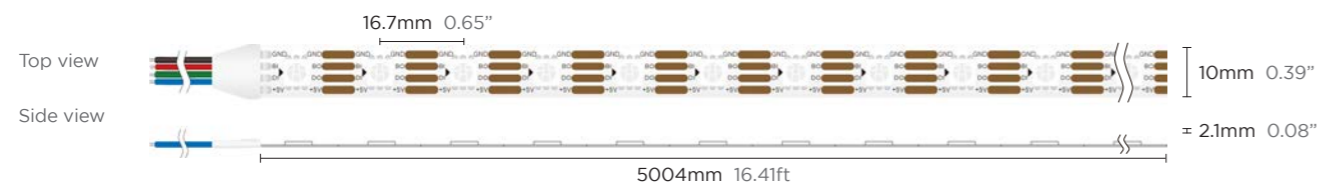

SPI Series / RGB / 5050SMD / 12V

60LEDS/M 14W

Product NO. AUSPI14WR-12VCLM-60L



Waterproof grade



Technical Details

| | |
|-------------------|--|
| Power | 14.4W/M 4.39W/ft |
| Voltage | DC12V |
| CRI | - |
| Led Qty | 60LEDS/M 18LEDS/ft |
| Color Temperature | ●R ●G ●B |
| Lumens | 615-625nm 105lm/m 32lm/ft 520-530nm 255lm/m 78lm/ft 460-470nm 60lm/m 18lm/ft |
| Length/Reel | 5M 16.41ft |
| Cutting Length | 50mm 1.96" |
| Waterproof grade | IP20/IP62/IP65/IP68 |

Note:'x' (CCT) =*27*(2700K) / *30*(3000K) / *40*(4000K) / *50*(5000K) / *60*(6000K), Please contact us for more information.

* Please contact our sales for the latest details and certifications

Dimension

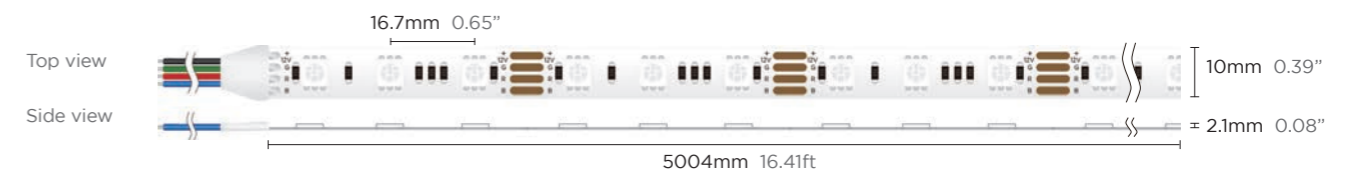

SPI Series / RGB / 5050SMD / 24V

60LEDS/M 14W

Product NO. AUSPI14WR-24VCLM-60L



Waterproof grade



Technical Details

| | | | | | | |
|-------------------|---------------------------|--|---------------------------|--|--------------------------|--|
| Power | 14.4W/M 4.39W/ft | | | | | |
| Voltage | DC24V | | | | | |
| CRI | - | | | | | |
| Led Qty | 60LEDS/M 18LEDS/ft | | | | | |
| Color Temperature | ● R | | ● G | | ● B | |
| Lumens | 615-625nm 110lm/m 34lm/ft | | 520-530nm 260lm/m 79lm/ft | | 460-470nm 60lm/m 18lm/ft | |
| Length/Reel | 5M 16.41ft | | | | | |
| Cutting Length | 100mm 3.93" | | | | | |
| Waterproof grade | IP20/IP62/IP65/IP68 | | | | | |

Note: 'x' (CCT) = "27"(2700K) / "30"(3000K) / "40"(4000K) / "50"(5000K) / "60"(6000K), Please contact us for more information.

* Please contact our sales for the latest details and certifications

Dimension

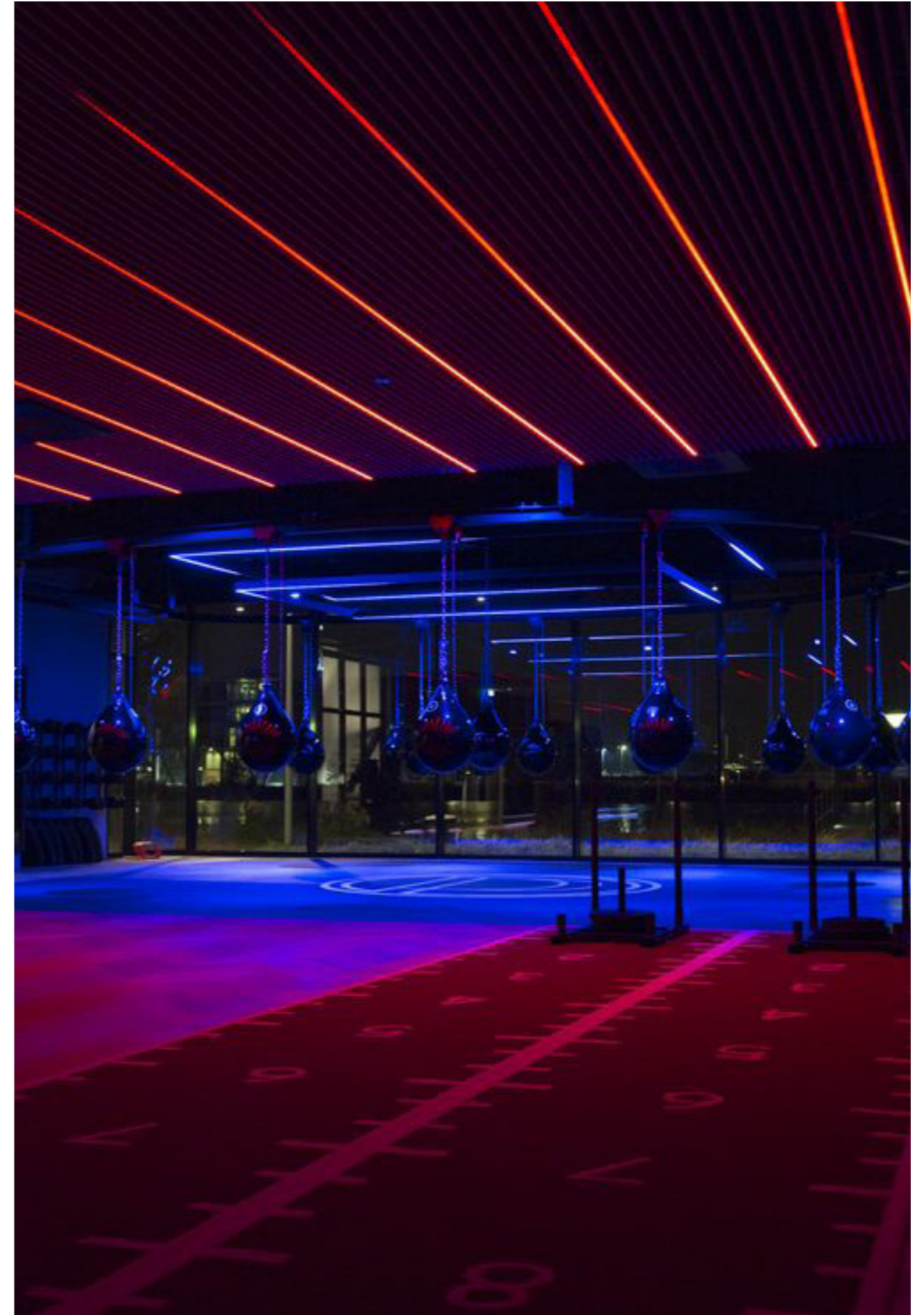
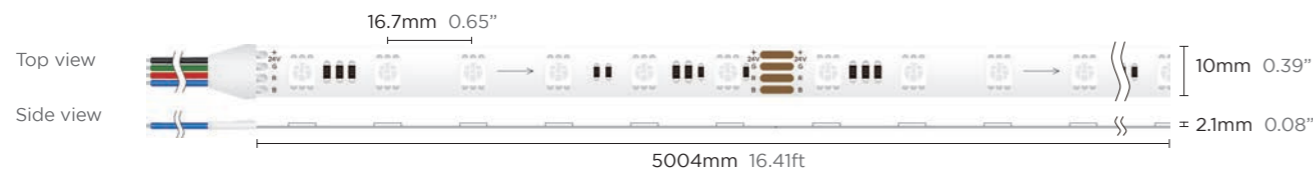

DMX Series

Colors jump & gradual changings can be realized by controller coding.
Varying color programs can be controlled by 10pixels per meter.
DMX512 control IC-SM18522PS.

DMX Series / CCT / 5050SMD / 24V

48LEDS/M 12W

Product NO. AUDMX12WW-24VCLM-48L



Waterproof grade



Technical Details

| | |
|-------------------------|---------------------|
| Power | 12W/M 3.66W/ft |
| Voltage | DC24V |
| CRI | 90 |
| Led Qty | 48LEDS/M 14LEDS/ft |
| Length/Reel | 5M 16.41ft |
| Cutting Length | 125mm 4.92" |
| Waterproof grade | IP20/IP62/IP65/IP68 |

Lumens

| | | |
|-------------------|---------|----------|
| Color Temperature | | |
| ● 2700K | 830lm/m | 253lm/ft |
| ● 3000K | 840lm/m | 256lm/ft |
| ● 4000K | 885lm/m | 270lm/ft |
| ● 5000K | 885lm/m | 270lm/ft |
| ● 6000K | 885lm/m | 270lm/ft |

Note: 'x' (CCT) = "27"(2700K) / "30"(3000K) / "40"(4000K) / "50"(5000K) / "60"(6000K), Please contact us for more information.
* Please contact our sales for the latest details and certifications

Dimension

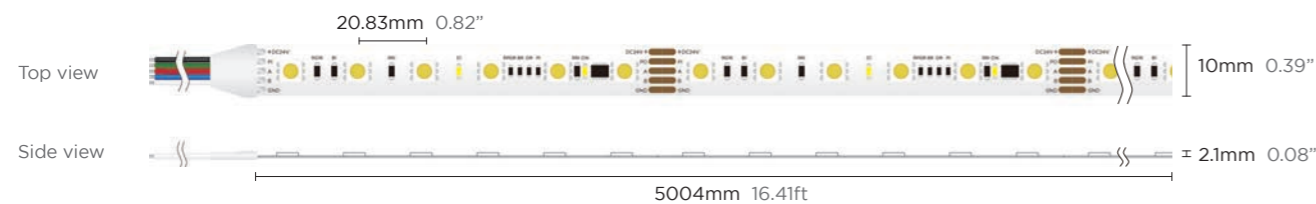

DMX Series / RGB / 5050SMD / 24V

48LEDS/M 12W

Product NO. AUDMX12WR-24VCLM-48L



Waterproof grade



Technical Details

| | | | |
|--------------------------|---------------------|-----------------|----------------|
| Power | 12W/M 3.66W/ft | | |
| Voltage | DC24V | | |
| CRI | - | | |
| Led Qty | 48LEDS/M 14LEDS/ft | | |
| Color Temperature | ● R | ● G | ● B |
| Lumens | 102lm/m 31lm/ft | 280lm/m 85lm/ft | 57lm/m 17lm/ft |
| Length/Reel | 5M 16.41ft | | |
| Cutting Length | 125mm 4.92" | | |
| Waterproof grade | IP20/IP62/IP65/IP68 | | |

Note: 'x' (CCT) = "27"(2700K) / "30"(3000K) / "40"(4000K) / "50"(5000K) / "60"(6000K), Please contact us for more information.
* Please contact our sales for the latest details and certifications

Dimension

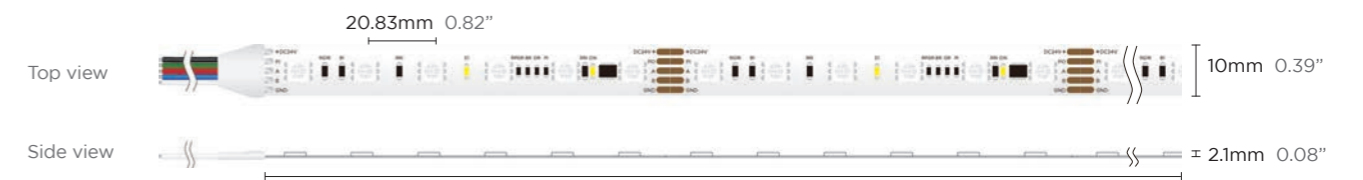

DMX Series / CCT / 5050SMD / 24V

56LEDS/M 12W

Product NO. AUDMX12WW-24VCLM-56L



Waterproof grade

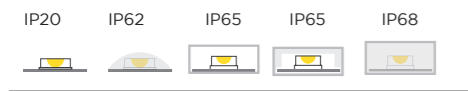

Technical Details

| | |
|-------------------------|---------------------|
| Power | 12W/M 3.66W/ft |
| Voltage | DC24V |
| CRI | 90 |
| Led Qty | 56LEDS/M 17LEDS/ft |
| Length/Reel | 5M 16.41ft |
| Cutting Length | 125mm 4.92" |
| Waterproof grade | IP20/IP62/IP65/IP68 |

Lumens

| Color Temperature | | |
|-------------------|----------|----------|
| ● 2700K | 960lm/m | 293lm/ft |
| ● 3000K | 995lm/m | 303lm/ft |
| ● 4000K | 1025lm/m | 313lm/ft |
| ● 5000K | 1025lm/m | 313lm/ft |
| ● 6000K | 1025lm/m | 313lm/ft |

Note: 'x' (CCT) = "27"(2700K) / "30"(3000K) / "40"(4000K) / "50"(5000K) / "60"(6000K), Please contact us for more information.
* Please contact our sales for the latest details and certifications

Dimension

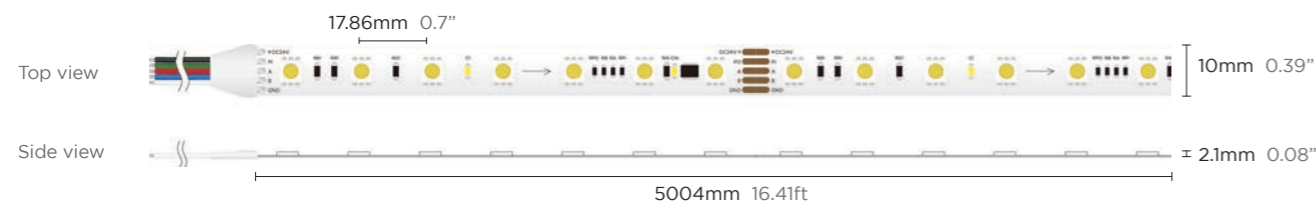

DMX Series / RGB / 5050SMD / 24V

56LEDS/M 12W

Product NO. AUDMX12WR-24VCLM-56L



Waterproof grade



Technical Details

| | |
|--------------------------|---|
| Power | 12W/M 3.65W/ft |
| Voltage | DC24V |
| CRI | - |
| Led Qty | 56LEDS/M 17LEDS/ft |
| Color Temperature | ● R ● G ● B |
| Lumens | 122lm/m 37lm/ft 331lm/m 101lm/ft 68lm/m 21lm/ft |
| Length/Reel | 5M 16.41ft |
| Cutting Length | 125mm 4.92" |
| Waterproof grade | IP20/IP62/IP65/IP68 |

Note: 'x' (CCT) = "27"(2700K) / "30"(3000K) / "40"(4000K) / "50"(5000K) / "60"(6000K), Please contact us for more information.
* Please contact our sales for the latest details and certifications

Dimension

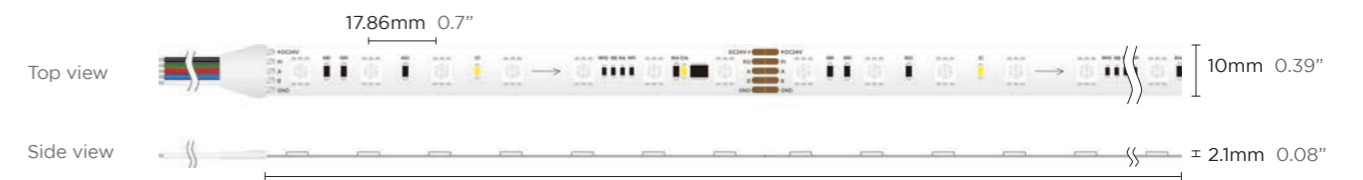

DMX Series / CCT / 5050SMD / 24V

60LEDs/M 14W

Product NO. AUDMX14WW-24VCLM-60L



Waterproof grade



Technical Details

| | |
|-------------------------|---------------------|
| Power | 14W/M 4.26W/ft |
| Voltage | DC24V |
| CRI | 90 |
| Led Qty | 60LEDs/M 18LEDs/ft |
| Length/Reel | 5M 16.41ft |
| Cutting Length | 100mm 3.93" |
| Waterproof grade | IP20/IP62/IP65/IP68 |

Lumens

| Color Temperature | | |
|-------------------|----------|----------|
| ● 2700K | 965lm/m | 294lm/ft |
| ● 3000K | 980lm/m | 299lm/ft |
| ● 4000K | 1035lm/m | 316lm/ft |
| ● 5000K | 1035lm/m | 316lm/ft |
| ● 6000K | 1035lm/m | 316lm/ft |

Note: 'x' (CCT) = "27"(2700K) / "30"(3000K) / "40"(4000K) / "50"(5000K) / "60"(6000K), Please contact us for more information.
* Please contact our sales for the latest details and certifications

Dimension

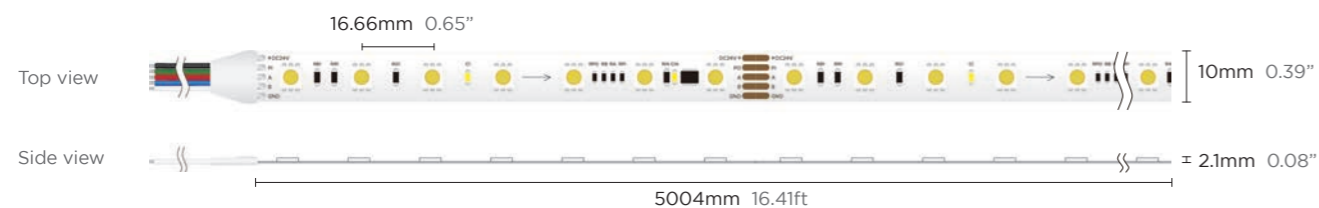

DMX Series / RGB / 5050SMD / 24V

60LEDs/M 14W

Product NO. AUDMX14WR-24VCLM-60L



Waterproof grade



Technical Details

| | | | | | | |
|--------------------------|---------------------|------------------|----------------|--|--|--|
| Power | 14W/M 4.26W/ft | | | | | |
| Voltage | DC24V | | | | | |
| CRI | - | | | | | |
| Led Qty | 60LEDs/M 18LEDs/ft | | | | | |
| Color Temperature | ● R | ● G | ● B | | | |
| Lumens | 125lm/m 38lm/ft | 355lm/m 108lm/ft | 75lm/m 23lm/ft | | | |
| Length/Reel | 5M 16.41ft | | | | | |
| Cutting Length | 100mm 3.93" | | | | | |
| Waterproof grade | IP20/IP62/IP65/IP68 | | | | | |

Note: 'x' (CCT) = "27"(2700K) / "30"(3000K) / "40"(4000K) / "50"(5000K) / "60"(6000K), Please contact us for more information.
* Please contact our sales for the latest details and certifications

Dimension

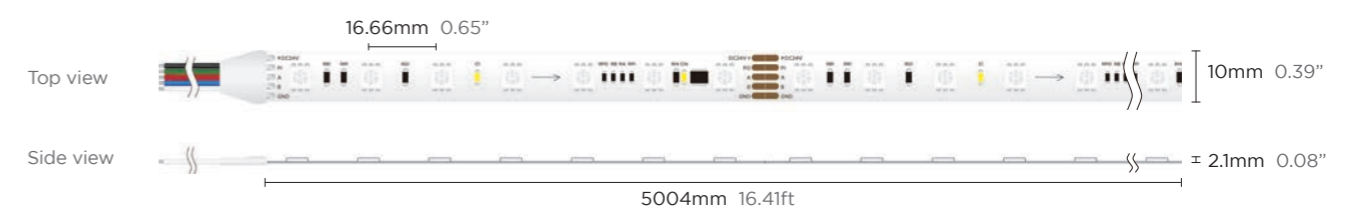

SPECIAL SERIES

Soft lighting

High voltage Series

4020 Side Emitting Series

160° Monolithic Integrated Lens

12V / 24V Switchable Series

Haute Color Series

Fresh food / jewelry lighting

S Type Series



Soft lighting 12x6mm

WHITE / RGB



Diffuse design, lights softer.
Bendable at horizontal direction.
IP67 protection.
Robust housing with high quality silicon, UV proof for true outdoor application.



Accessories



2700K 3000K 4000K 6000K



Technical Details 1206 White 14W

1206 RGB 14W

| | | |
|-------------------|---|--|
| Product NO. | AUSL14WW-24VCLM-60L1206 | AUSL14WR-24VCLM-60L1206 |
| Voltage | DC24V | DC24V |
| Power | 14W/M 4.26W/ft | 14W/M 4.26W/ft |
| CRI | 90 | 90 |
| Led Qty | 60LEDs/M 18LEDs/ft | 60LEDs/M 18LEDs/ft |
| Cutting Length | 100mm 3.93" | 100mm 3.93" |
| Waterproof grade | IP67 | IP67 |
| Length/Reel | 5050mm 16.56ft | 5050mm 16.56ft |
| Color temperature | ● 2700K ● 3000K ● 4000K ○ 6000K | ● R ● G ● B |
| Lumens | 1204lm/m 367lm/ft 1274lm/m 388lm/ft 1302lm/m 397lm/ft 1302lm/m 397lm/ft | 126lm/m 38m/ft 350lm/m 107lm/ft 71lm/m 22lm/ft |

Note: 'x' (CCT) = "27"(2700K) / "30"(3000K) / "40"(4000K) / "50"(5000K) / "60"(6000K), Please contact us for more information.

Dimension

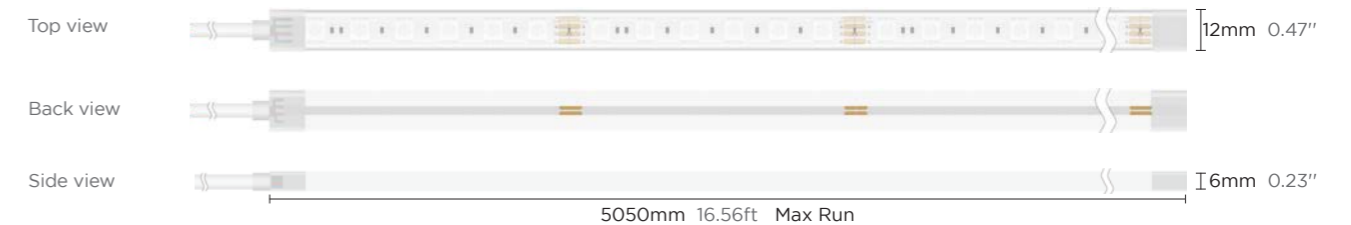

※ Please contact our sales for the latest details and certifications

High Voltage Strips

Ultra-long, up to 50 meters with one end feed.
Stable constant current solution.
Passed CE, RoHS certified.



SPECIAL SERIES · HIGH VOLTAGE STRIPS



| Technical Details | 72LEDs/M 9W CE | 96LEDs/M 10W |
|-------------------|----------------------|----------------------|
| | AUHV09WW-220VCLM-72L | AUHV10WW-220VCLM-96L |
| Power | 9W/M 2.74W/ft | 10W/M 3.04W/ft |
| Voltage | AC220V | AC220V |
| CRI | 80 | 80 |
| Led Qty | 72LEDs/M 21LEDs/ft | 96LEDs/M 29LEDs/ft |
| Length/Reel | 50M 164.04ft | 50M 164.04ft |
| Waterproof grade | IP65 | IP65 |

| Technical Details | 104LEDs/M 12W | 120LEDs/M 14W |
|-------------------|-----------------------|-----------------------|
| | AUHV12WW-220VCLM-104L | AUHV14WW-220VCLM-120L |
| Power | 12W/M 3.65W/ft | 14W/M 4.26W/ft |
| Voltage | AC220V | AC220V |
| CRI | 80 | 80 |
| Led Qty | 104LEDs/M 31LEDs/ft | 120LEDs/M 36LEDs/ft |
| Length/Reel | 50M 164.04ft | 50M 164.04ft |
| Waterproof grade | IP65 | IP65 |

| Lumens | 72LEDs/M 9W CE | 96LEDs/M 10W | 104LEDs/M 12W | 120LEDs/M 14W |
|---------|------------------|-------------------|-------------------|-------------------|
| ● 3000K | 850lm/m 259lm/ft | 1000lm/m 305lm/ft | 1200lm/m 366lm/ft | 1330lm/m 405lm/ft |
| ● 4000K | 900lm/m 274lm/ft | 1050lm/m 320lm/ft | 1260lm/m 384lm/ft | 1400lm/m 427lm/ft |
| ● 6500K | 900lm/m 274lm/ft | 1050lm/m 320lm/ft | 1260lm/m 384lm/ft | 1400lm/m 427lm/ft |

Note: 'x' (CCT) = "27"(2700K) / "30"(3000K) / "40"(4000K) / "50"(5000K) / "60"(6000K), Please contact us for more information.

* Please contact our sales for the latest details and certifications

Dimension

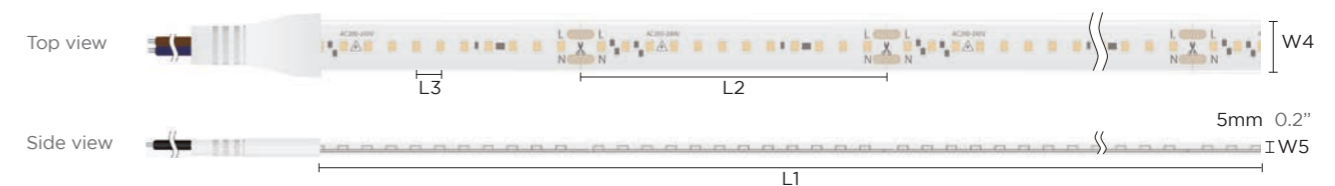

| | L1 | L2 | L3 | W4 |
|-----------------------|--------------|---------------|--------------|------------|
| AUHV09WW-220VCLM-72L | 50m 164.04ft | 166.7mm 6.56" | 13.9mm 0.54" | 14mm 0.55" |
| AUHV10WW-220VCLM-96L | 50m 164.04ft | 125mm 4.92" | 10.4mm 0.4" | 14mm 0.55" |
| AUHV12WW-220VCLM-104L | 50m 164.04ft | 125mm 4.92" | 10.4mm 0.4" | 14mm 0.55" |
| AUHV14WW-220VCLM-120L | 50m 164.04ft | 100mm 3.94" | 8.3mm 0.32" | 14mm 0.55" |

SPECIAL SERIES · HIGH VOLTAGE STRIPS

4020 Side Emitting Series

Suitable for ultra-thin light box, counters, crevices, etc.
 High light efficiency, up to 120LM/W.
 High color consistency, SDCM<5.



SPECIAL SERIES · 4020 SIDE EMITTING SERIES



Product NO. AUSES04WW-24VCLM

Technical Details

| | |
|------------------|--------------------|
| Power | 4.8W/M 1.46W/ft |
| Voltage | DC24V |
| CRI | 90 |
| Led Qty | 70LEDs/M 21LEDs/ft |
| Length/Reel | 5M 16.41ft |
| Waterproof grade | IP20 |

Lumens

| Color Temperature | | |
|-------------------|---------|----------|
| 2700K | 530lm/m | 162lm/ft |
| 3000K | 550lm/m | 168lm/ft |
| 4000K | 580lm/m | 177lm/ft |
| 5000K | 580lm/m | 177lm/ft |
| 6000K | 550lm/m | 168lm/ft |

Product NO. AUSES09WW-24VCLM

Technical Details

| | |
|------------------|---------------------|
| Power | 9.6W/M 2.93W/ft |
| Voltage | DC24V |
| CRI | 90 |
| Led Qty | 140LEDs/M 42LEDs/ft |
| Length/Reel | 5M 16.41ft |
| Waterproof grade | IP20 |

Lumens

| Color Temperature | | |
|-------------------|----------|----------|
| 2700K | 1060lm/m | 323lm/ft |
| 3000K | 1100lm/m | 335lm/ft |
| 4000K | 1160lm/m | 354lm/ft |
| 5000K | 1160lm/m | 354lm/ft |
| 6000K | 1100lm/m | 335lm/ft |

Note: 'x' (CCT) = *27*(2700K) / *30*(3000K) / *40*(4000K) / *50*(5000K) / *60*(6000K), Please contact us for more information.

* Please contact our sales for the latest details and certifications

SPECIAL SERIES · 4020 SIDE EMITTING SERIES

Dimension

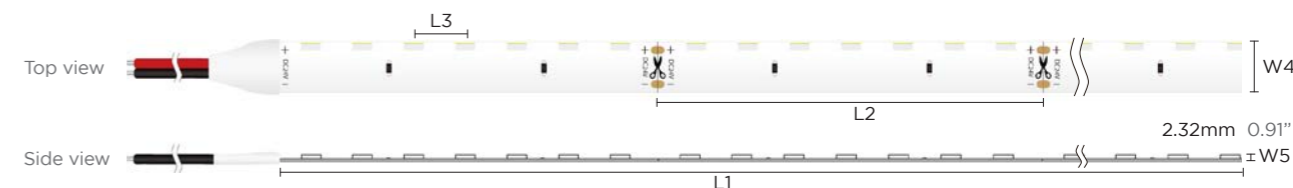

| | L1 | L2 | L3 | W4 |
|------------------|------------|-------------|--------------|-----------|
| AUSES04WW-24VCLM | 5m 16.41ft | 100mm 3.93" | 14.3mm 0.56" | 8mm 0.31" |
| AUSES09WW-24VCLM | 5m 16.41ft | 50mm 1.96" | 7.1mm 0.27" | 8mm 0.31" |

160° Monolithic Integrated Lens

With lens large angle 160°, replace traditional diffuse reflectors.
2700-6000K Multi-color temperature optional.



SPECIAL SERIES -160° MONOLITHIC INTEGRATED LENS

SPECIAL SERIES -160° MONOLITHIC INTEGRATED LENS

Technical Details

Product NO. AUMIL09WW-24VCLM160°

| | |
|------------------|-------------------|
| Power | 9.6W/M 2.93W/ft |
| Voltage | DC24V |
| CRI | 80 |
| Led Qty | 24LEDs/M 7LEDs/ft |
| Length/Reel | 5M 16.41ft |
| Waterproof grade | IP20 |

Lumens

| Color Temperature | | |
|-------------------|----------|----------|
| 2700K | 1200lm/m | 366lm/ft |
| 3000K | 1250lm/m | 381lm/ft |
| 4000K | 1300lm/m | 396lm/ft |
| 5000K | 1300lm/m | 396lm/ft |
| 6000K | 1250lm/m | 381lm/ft |

Product NO. AUMIL14WW-24VCLM160°

| | |
|------------------|--------------------|
| Power | 14.4W/M 4.39W/ft |
| Voltage | DC24V |
| CRI | 80 |
| Led Qty | 48LEDs/M 14LEDs/ft |
| Length/Reel | 5M 16.41ft |
| Waterproof grade | IP20 |

Lumens

| Color Temperature | | |
|-------------------|----------|----------|
| 2700K | 1850lm/m | 564lm/ft |
| 3000K | 1950lm/m | 595lm/ft |
| 4000K | 2050lm/m | 625lm/ft |
| 5000K | 2050lm/m | 625lm/ft |
| 6000K | 1950lm/m | 595lm/ft |

Product NO. AUMIL19WW-24VCLM160°

| | |
|------------------|--------------------|
| Power | 19.2W/M 5.85W/ft |
| Voltage | DC24V |
| CRI | 80 |
| Led Qty | 64LEDs/M 19LEDs/ft |
| Length/Reel | 5M 16.41ft |
| Waterproof grade | IP20 |

Lumens

| Color Temperature | | |
|-------------------|----------|----------|
| 2700K | 2500lm/m | 762lm/ft |
| 3000K | 2600lm/m | 793lm/ft |
| 4000K | 2700lm/m | 823lm/ft |
| 5000K | 2700lm/m | 823lm/ft |
| 6000K | 2600lm/m | 793lm/ft |

Note: 'x' (CCT) = "27"(2700K) / "30"(3000K) / "40"(4000K) / "50"(5000K) / "60"(6000K), Please contact us for more information.

* Please contact our sales for the latest details and certifications

Dimension

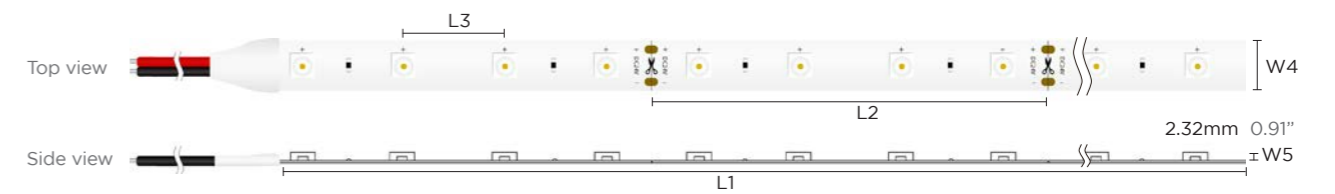

| | L1 | L2 | L3 | W4 |
|----------------------|------------|----------------|---------------|------------|
| AUMIL09WW-24VCLM160° | 5m 16.41ft | 166.67mm 6.56" | 41.66mm 1.64" | 10mm 0.39" |
| AUMIL14WW-24VCLM160° | 5m 16.41ft | 83.3mm 3.27" | 20.83mm 0.82" | 10mm 0.39" |
| AUMIL19WW-24VCLM160° | 5m 16.41ft | 62.5mm 2.46" | 15.62mm 0.61" | 10mm 0.39" |

12V/24V Switchable Series

High CRI, CRI>90.
 High efficiency.
 High color consistency, SDCM<5, optional for SDCM<3.
 12V and 24V power supply can be selected for different wiring modes.



SPECIAL SERIES · 12V/24V SWITCHABLE SERIES

Technical Details

Product NO. AUSS04WW-24VCLM

| | |
|------------------|--------------------|
| Power | 4.8W/M 1.46W/ft |
| Voltage | DC12V/DC24V |
| CRI | 90 |
| Led Qty | 60LEDs/M 18LEDs/ft |
| Length/Reel | 5M 16.41ft |
| Waterproof grade | IP20 |

Lumens

| Color Temperature | | |
|-------------------|---------|----------|
| 2700K | 380lm/m | 116lm/ft |
| 3000K | 400lm/m | 122lm/ft |
| 4000K | 440lm/m | 134lm/ft |
| 5000K | 440lm/m | 134lm/ft |
| 6000K | 430lm/m | 131lm/ft |

Product NO. AUSS09WW-24VCLM

| | |
|------------------|---------------------|
| Power | 9.6W/M 2.93W/ft |
| Voltage | DC12V/DC24V |
| CRI | 90 |
| Led Qty | 120LEDs/M 36LEDs/ft |
| Length/Reel | 5M 16.41ft |
| Waterproof grade | IP20 |

Lumens

| Color Temperature | | |
|-------------------|---------|----------|
| 2700K | 770lm/m | 235lm/ft |
| 3000K | 800lm/m | 244lm/ft |
| 4000K | 900lm/m | 274lm/ft |
| 5000K | 900lm/m | 274lm/ft |
| 6000K | 880lm/m | 268lm/ft |

Note: 'x' (CCT) = "27"(2700K) / "30"(3000K) / "40"(4000K) / "50"(5000K) / "60"(6000K), Please contact us for more information.

* Please contact our sales for the latest details and certifications

SPECIAL SERIES · 12V/24V SWITCHABLE SERIES

Dimension

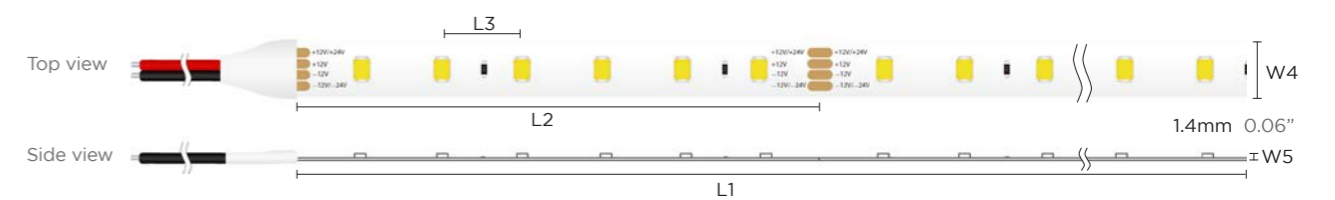

| | L1 | L2 | L3 | W4 |
|-----------------|------------|-------------|--------------|-----------|
| AUSS04WW-24VCLM | 5m 16.41ft | 100mm 3.93" | 16.7mm 0.65" | 8mm 0.31" |
| AUSS09WW-24VCLM | 5m 16.41ft | 50mm 1.96" | 8.3mm 0.32" | 8mm 0.31" |

Haute Color Series

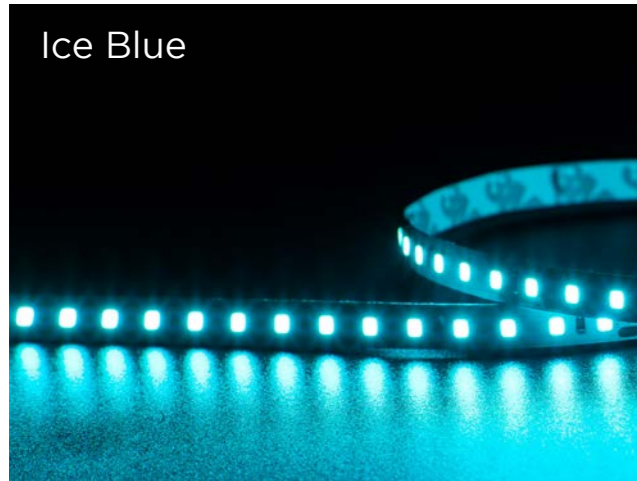

Ice Blue



Pink



Tomato



Violet



Rose red



Golden Light

Ice Blue
AUHCS09WIB-24VCLM

| | |
|---------|---------------------|
| Power | 9.6W/M 2.93W/ft |
| Voltage | DC24V |
| Led Qty | 120LEDs/M 36LEDs/ft |
| Lumens | 550lm/m 168lm/ft |
| Prpc WL | Ld=488.8nm |
| Peak WL | Lp=493nm |

Pink
AUHCS09WP-24VCLM

| | |
|---------|---------------------|
| Power | 9.6W/M 2.93W/ft |
| Voltage | DC24V |
| Led Qty | 120LEDs/M 36LEDs/ft |
| Lumens | 650lm 198lm/ft |
| Prpc WL | Ld=501.2nm |
| Peak WL | Lp=451nm |

Tomato
FAUHCS09WT-24VCLM

| | |
|---------|---------------------|
| Power | 9.6W/M 2.93W/ft |
| Voltage | DC24V |
| Led Qty | 120LEDs/M 36LEDs/ft |
| Lumens | 645lm 197lm/ft |
| Prpc WL | Ld=607.9nm |
| Peak WL | Lp=613nm |

Violet
AUHCS09WV-24VCLM

| | |
|---------|---------------------|
| Power | 9.6W/M 2.93W/ft |
| Voltage | DC24V |
| Led Qty | 120LEDs/M 36LEDs/ft |
| Lumens | 205lm 63lm/ft |
| Prpc WL | Ld=439.8nm |
| Peak WL | Lp=451nm |

Rose red
FAUHCS09WRR-24VCLM

| | |
|---------|---------------------|
| Power | 9.6W/M 2.93W/ft |
| Voltage | DC24V |
| Led Qty | 120LEDs/M 36LEDs/ft |
| Lumens | 360lm 110lm/ft |
| Prpc WL | Ld=552.9nm |
| Peak WL | Lp=451nm |

Golden Light
AUHCS09WG-24VCLM

| | |
|---------|---------------------|
| Power | 9.6W/M 2.93W/ft |
| Voltage | DC24V |
| Led Qty | 120LEDs/M 36LEDs/ft |
| Lumens | 1030lm 314lm/ft |
| Prpc WL | Ld=590nm |
| Peak WL | Lp=594nm |

Dimension



| L1 | L2 | L3 | W4 | IP |
|------------|------------|-------------|-----------|------|
| 5m 16.41ft | 50mm 1.96" | 8.3mm 0.32" | 8mm 0.31" | IP20 |

SPECIAL SERIES · HAUTE COLOR SERIES

SPECIAL SERIES · HAUTE COLOR SERIES

Fresh food / jewelry lighting



| | |
|------------------------------|---------------------|
| Cake/Cheese AUFFJ14WC-24VCLM | |
| Power | 14W/M 4.26W/ft |
| Voltage | DC24V |
| Led Qty | 192LEDs/M 59LEDs/ft |
| Lumens | 1610lm/m 491lm/ft |
| Prpc WL | Ld=588nm |
| Peak WL | Lp=627nm |

| | |
|---------------------------|---------------------|
| Seafood AUFFJ14WS-24VCLM5 | |
| Power | 14W/M 4.26W/ft |
| Voltage | DC24V |
| Led Qty | 192LEDs/M 59LEDs/ft |
| Lumens | 1930lm/m 588lm/ft |
| Prpc WL | Ld=580nm |
| Peak WL | Lp=456nm |

| | |
|------------------------|---------------------|
| Fruit AUFFJ14WF-24VCLM | |
| Power | 14W/M 4.26W/ft |
| Voltage | DC24V |
| Led Qty | 192LEDs/M 59LEDs/ft |
| Lumens | 1680lm/m 512lm/ft |
| Prpc WL | Ld=584nm |
| Peak WL | Lp=623nm |

| | |
|------------------------------|---------------------|
| Pickled ham AUFFJ14WP-24VCLM | |
| Power | 14W/M 4.26W/ft |
| Voltage | DC24V |
| Led Qty | 192LEDs/M 59LEDs/ft |
| Lumens | 2100lm/m 640lm/ft |
| Prpc WL | Ld=494nm |
| Peak WL | Lp=452nm |

| | |
|------------------------------|---------------------|
| Fresh Meat AUFFJ14WFM-24VCLM | |
| Power | 14W/M 4.26W/ft |
| Voltage | DC24V |
| Led Qty | 192LEDs/M 59LEDs/ft |
| Lumens | 1330lm/m 405lm/ft |
| Prpc WL | Ld=603nm |
| Peak WL | Lp=630nm |

| | |
|------------------------|---------------------|
| Break AUFFJ14WB-24VCLM | |
| Power | 14W/M 4.26W/ft |
| Voltage | DC24V |
| Led Qty | 192LEDs/M 59LEDs/ft |
| Lumens | 1620lm/m 494lm/ft |
| Prpc WL | Ld=585nm |
| Peak WL | Lp=620nm |



| | |
|-----------------------------------|---------------------|
| Jadeite lighting AUFFJ14WJ-24VCLM | |
| Power | 14W/M 4.26W/ft |
| Voltage | DC24V |
| Led Qty | 192LEDs/M 59LEDs/ft |
| Lumens | 1540lm/m 470lm/ft |
| Prpc WL | Ld=581nm |
| Peak WL | Lp=457nm |

| | |
|-------------------------------------|---------------------|
| Cosmetic lighting AUFFJ14WCL-24VCLM | |
| Power | 14W/M 4.26W/ft |
| Voltage | DC24V |
| Led Qty | 192LEDs/M 59LEDs/ft |
| Lumens | 1840lm/m 561lm/ft |
| Prpc WL | Ld=579nm |
| Peak WL | Lp=456nm |

| | |
|----------------------------------|---------------------|
| Golden lighting AUFFJ14WG-24VCLM | |
| Power | 14W/M 4.26W/ft |
| Voltage | DC24V |
| Led Qty | 192LEDs/M 59LEDs/ft |
| Lumens | 1650lm/m 503lm/ft |
| Prpc WL | Ld=590nm |
| Peak WL | Lp=634nm |

| | |
|-----------------------------------|---------------------|
| Diamond lighting AUFFJ14WD-24VCLM | |
| Power | 14W/M 4.26W/ft |
| Voltage | DC24V |
| Led Qty | 192LEDs/M 59LEDs/ft |
| Lumens | 1680lm/m 512lm/ft |
| Prpc WL | Ld=480nm |
| Peak WL | Lp=455nm |

| | |
|------------------------------------|---------------------|
| Crystal lighting AUFFJ14WCL-24VCLM | |
| Power | 14W/M 4.26W/ft |
| Voltage | DC24V |
| Led Qty | 192LEDs/M 59LEDs/ft |
| Lumens | 1980lm/m 470lm/ft |
| Prpc WL | Ld=579nm |
| Peak WL | Lp=456nm |

Dimension

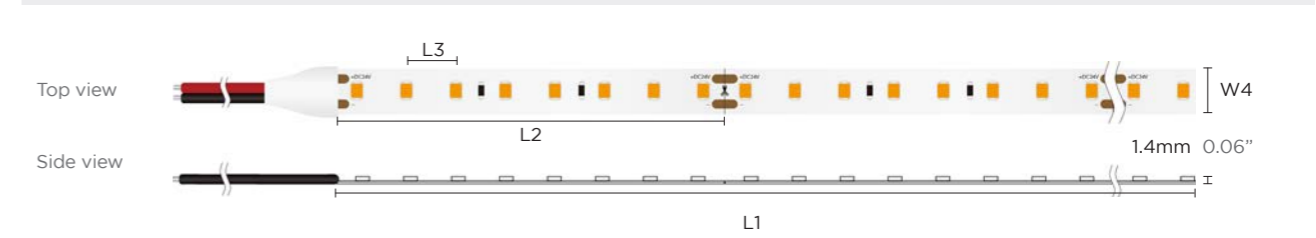

| L1 | L2 | L3 | W4 | IP |
|------------|--------------|-------------|------------|------|
| 5m 16.41ft | 41.7mm 1.64" | 5.21mm 0.2" | 10mm 0.39" | IP20 |

SPECIAL SERIES · FRESH FOOD / JEWELRY LIGHTING

SPECIAL SERIES · FRESH FOOD / JEWELRY LIGHTING

S type Series / 12V

White



Designed for signs, sculptured lettering and back lit lighting.
Easy to install around tight corners.
Continuous length up to 5m.



White/ 60LEDs

Product NO. AUST04WW-12VCLM60L

| | |
|------------------|--------------------|
| Power | 4.8W/M 1.46W/ft |
| Voltage | DC12V |
| CRI | 90 |
| Led Qty | 60LEDs/M 18LEDs/ft |
| Length/Reel | 5m 16.41ft |
| Cutting Length | 50mm 1.97" |
| Waterproof grade | IP20 |
| Lumens | |
| ● 2700K | 435lm/m 133lm/ft |
| ● 3000K | 455lm/m 139lm/ft |
| ● 4000K | 475lm/m 145lm/ft |
| ● 5000K | 475lm/m 145lm/ft |
| ● 6000K | 475lm/m 145lm/ft |

White/ 120LEDs

Product NO. AUST04WW-12VCLM120L

| | |
|------------------|---------------------|
| Power | 4.8W/M 1.46W/ft |
| Voltage | DC12V |
| CRI | 90 |
| Led Qty | 120LEDs/M 36LEDs/ft |
| Length/Reel | 5m 16.41ft |
| Cutting Length | 25mm 0.98" |
| Waterproof grade | IP20 |
| Lumens | |
| ● 2700K | 435lm/m 133lm/ft |
| ● 3000K | 455lm/m 139lm/ft |
| ● 4000K | 480lm/m 146lm/ft |
| ● 5000K | 480lm/m 146lm/ft |
| ● 6000K | 480lm/m 146lm/ft |

Note:'x' (CCT) = "27"(2700K) / "30"(3000K) / "40"(4000K) / "50"(5000K) / "60"(6000K), Please contact us for more information.
* Please contact our sales for the latest details and certifications

Dimension



S type Series / 24V

White



Designed for signs, sculptured lettering and back lit lighting.
Easy to install around tight corners.
Continuous length up to 5m.



White/ 60LEDs

Product NO. AUST09WW-24VCLM60L

| | |
|------------------|--------------------|
| Power | 9.6W/M 2.92W/ft |
| Voltage | DC24V |
| CRI | 90 |
| Led Qty | 60LEDs/M 18LEDs/ft |
| Length/Reel | 5m 16.41ft |
| Cutting Length | 100mm 3.93" |
| Waterproof grade | IP20 |
| Lumens | |
| ● 2700K | 864lm/m 263lm/ft |
| ● 3000K | 900lm/m 274lm/ft |
| ● 4000K | 930lm/m 284lm/ft |
| ● 5000K | 930lm/m 284lm/ft |
| ● 6000K | 930lm/m 284lm/ft |

White/ 120LEDs

Product NO. AUST04WW-24VCLM120L

| | |
|------------------|---------------------|
| Power | 4.8W/M 1.46W/ft |
| Voltage | DC24V |
| CRI | 90 |
| Led Qty | 120LEDs/M 36LEDs/ft |
| Length/Reel | 5m 16.41ft |
| Cutting Length | 50mm 1.97" |
| Waterproof grade | IP20 |
| Lumens | |
| ● 2700K | 430lm/m 131lm/ft |
| ● 3000K | 450lm/m 137lm/ft |
| ● 4000K | 470lm/m 143lm/ft |
| ● 5000K | 470lm/m 143lm/ft |
| ● 6000K | 470lm/m 143lm/ft |

Note:'x' (CCT) = "27"(2700K) / "30"(3000K) / "40"(4000K) / "50"(5000K) / "60"(6000K), Please contact us for more information.
* Please contact our sales for the latest details and certifications

Dimension



S type Series / 24V

Designed for signs, sculptured lettering and back lit lighting.

Easy to install around tight corners.

Continuous length up to 5m.



RGB



48LEDs

Product NO. AUST09WR-24VCLM48L

| | |
|------------------|--------------------|
| Power | 9.6W/M 2.92W/ft |
| Voltage | DC24V |
| CRI | /(5050 SMD) |
| Led Qty | 48LEDs/M 14LEDs/ft |
| Length/Reel | 5m 16.41ft |
| Cutting Length | 125mm 4.92" |
| Waterproof grade | IP20 |

Lumens

| R | G | B |
|--------------------|---------------------|-------------------|
| 124lm/m 38lm/ft | 345lm/m 105lm/ft | 67lm/m 20lm/ft |

RGBW



48LEDs

Product NO. AUST14WRW-24VCLM48L

| | |
|------------------|--------------------|
| Power | 14.4W/M 4.39W/ft |
| Voltage | DC24V |
| CRI | 80(5050 SMD) |
| Led Qty | 48LEDs/M 14LEDs/ft |
| Length/Reel | 5m 16.41ft |
| Cutting Length | 125mm 4.92" |
| Waterproof grade | IP20 |

Lumens

| R | G | B | 4000K |
|--------------------|---------------------|-------------------|---------------------|
| 128lm/m 39lm/ft | 333lm/m 102lm/ft | 87lm/m 27lm/ft | 415lm/m 127lm/ft |

Dimension



CONNECTORS

Single Color / IP20

| Series | Product | | | PCB Width | LED QTY | Product NO. |
|--|---|---|---|---------------|------------------------------|--|
| | BB PCB to PCB | XB Cable to PCB | BXB PCB to Cable to PCB | | | |
| AULD-SR Series Maximum voltage: 36V Maximum current: 3A |  |  |  | 8mm 0.31" | 60-180LEDs/M 18-55LEDs/ft | ALD-SR-8BB-U2Q ALD-SR-8XB-U2Q ALD-SR-8BxB-U2Q |
| | | | | 10mm 0.39" | 30-180LEDs/M 9-55LEDs/ft | ALD-SR-10BB-U2Q ALD-SR-10XB-U2Q ALD-SR-10BxB-U2Q |
| AULD-SE Series Maximum voltage: 36V Maximum current: 5A |  |  | / | 8mm 0.31" | 60-120LEDs/M 18-36LEDs/ft | ALD-SE-N8XB-U2 ALD-SE-N8BB-U2 |
| | | | | 10mm 0.39" | 60-160LEDs/M 18-36LEDs/ft | ALD-SE-N10XB-U2 ALD-SE-N10BB-U2 |
| | | | | | 64-240LEDs/M 19-73LEDs/ft | ALD-SE-N10XB-U2G ALD-SE-N10BB-U2G |
| 12mm 0.47" | 64-240LEDs/M 19-73LEDs/ft | ALD-SE-N12XB-U2G ALD-SE-N12BB-U2G | | | | |
| AULD-SL Series Maximum voltage: 36V Maximum current: 5A |  |  | / | 8mm 0.31" | 60-240LEDs/M 18-73LEDs/ft | ALD-SL-8BB-U2 ALD-SL-8XB-U2 ALD-SL-8BxB-U2 |
| | | | | 10mm 0.39" | 60-240LEDs/M 18-73LEDs/ft | ALD-SL-10BB-U2 ALD-SL-10XB-U2 ALD-SL-10BxB-U2 |

CONNECTORS

RGB / IP20





| Series | Product | | | PCB Width | LED QTY | Product NO. |
|--|--|--|---|---------------|-----------------------------|---|
| | BB PCB to PCB | XB Cable to PCB | BXB PCB to Cable to PCB | | | |
| AULD-SR Series Maximum voltage: 36V Maximum current: 3A |  |  |  | 10mm 0.39" | 30-140LEDs/M 9-44LEDs/ft | ALD-SR-10BB-U4 ALD-SR-10XB-U4 ALD-SR-10BxB-U4 |
| AULD-SE Series Maximum voltage: 36V Maximum current: 5A |  |  | / | 10mm 0.39" | 30-144LEDs/M 9-44LEDs/ft | ALD-SE-N10XB-U4 ALD-SE-N10BB-U4 |
| AULD-SL Series Maximum voltage: 36V Maximum current: 6A |  |  | / | 10mm 0.39" | 30-144LEDs/M 9-44LEDs/ft | ALD-SL-10BB-U4 ALD-SL-10XB-U4 |

CONNECTORS





Tunable / IP20

| Series | Product | | | PCB Width | LED QTY | Product NO. |
|--|---|---|----------------------------|---------------|------------------------------|------------------------------------|
| | BB PCB to PCB | XB Cable to PCB | BXB PCB to Cable to PCB | | | |
| AULD-SE Series Maximum voltage: 36V Maximum current: 5A |  |  | Not BXB | 10mm 0.39" | 60-120LEDs/M 18-36LEDs/ft | ALD-SE-N10XB-U3 ALD-SE-N10BB-U3 |
| AULD-SL Series Maximum voltage: 36V Maximum current: 6A |  |  | / | 10mm 0.39" | 60-120LEDs/M 18-36LEDs/ft | ALD-SL-10BB-U3 ALD-SL-10XB-U3 |



RGBW / IP20

| Series | Product | | | PCB Width | LED QTY | Product NO. |
|--|---|---|---|---------------|---------|---|
| | BB PCB to PCB | XB Cable to PCB | BXB PCB to Cable to PCB | | | |
| AULD-SR Series Maximum voltage: 36V Maximum current: 3A |  |  |  | 12mm 0.47" | - | ALD-SR-12BB-U5 ALD-SR-12XB-U5 ALD-SR-12BxB-U5 |
| AULD-SE Series Maximum voltage: 36V Maximum current: 5A |  |  | / | 12mm 0.47" | - | ALD-SE-N12XB-U5 ALD-SE-N12BB-U5 |

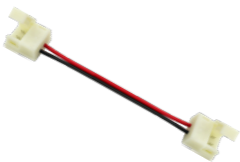



Single Color / IP62

| Series | Product | | | PCB Width | LED QTY | Product NO. |
|---|---|---|---|---------------|------------------------------|---|
| | BB PCB to PCB | XB Cable to PCB | BXB PCB to Cable to PCB | | | |
| AULD-SE Series Maximum voltage: 36V Maximum current: 5A |  |  | / | 8mm 0.31" | 60-120LEDs/M 18-36LEDs/ft | ALD-DJ-N8XB-U2 ALD-DJ-N8BB-U2 |
| | | | | 10mm 0.39" | 60-160LEDs/M 18-48LEDs/ft | ALD-DJ-N10XB-U2 ALD-DJ-N10BB-U2 |
| AULD-DJ Series Maximum voltage: 36V Maximum current: 4A |  |  |  | 8mm 0.31" | 60-120LEDs/M 18-36LEDs/ft | ALD-DJ-8BB-U2 ALD-DJ-8XB-U2 ALD-DJ-8BXB-U2 |
| | | | | 10mm 0.39" | 60-128LEDs/M 18-39LEDs/ft | ALD-DJ-10BB-U2 ALD-DJ-10XB-U2 ALD-DJ-10BXB-U2 |



Tunable / IP62

| Series | Product | | | PCB Width | LED QTY | Product NO. |
|---|--|--|----------------------------|---------------|-------------------------------|------------------------------------|
| | BB PCB to PCB | XB Cable to PCB | BXB PCB to Cable to PCB | | | |
| AULD-SE Series Maximum voltage: 36V Maximum current: 5A |  |  | / | 10mm 0.39" | 60-120 LEDs/M 18-36LEDs/ft | ALD-DJ-N10XB-U3 ALD-DJ-N10BB-U3 |



RGB / IP62

| Series | Product | | | PCB Width | LED QTY | Product NO. |
|---|---|---|---|---------------|------------------------------|---|
| | BB PCB to PCB | XB Cable to PCB | BXB PCB to Cable to PCB | | | |
| AULD-SE Series Maximum voltage: 36V Maximum current: 5A |  |  | / | 10mm 0.39" | 30-144 LEDs/M 9-44LEDs/ft | ALD-DJ-N10XB-U4 ALD-DJ-N10BB-U4 |
| AULD-DJ Series Maximum voltage: 36V Maximum current: 4A |  |  |  | 10mm 0.39" | 30-144 LEDs/M 9-44LEDs/ft | ALD-DJ-10BB-U4 ALD-DJ-10XB-U4 ALD-DJ-10BXB-U4 |



RGBW / IP62

| Series | Product | | | PCB Width | LED QTY | Product NO. |
|---|---|---|----------------------------|---------------|---------|------------------------------------|
| | BB PCB to PCB | XB Cable to PCB | BXB PCB to Cable to PCB | | | |
| AULD-SE Series Maximum voltage: 36V Maximum current: 5A |  |  | / | 12mm 0.39" | - | ALD-DJ-N12XB-U5 ALD-DJ-N12BB-U5 |

Single Color / IP65

| Series | Product | | | PCB Width | LED QTY | Product NO. |
|---|---|---|----------------------------|---------------|------------------------------|------------------------------------|
| | BB PCB to PCB | XB Cable to PCB | BXB PCB to Cable to PCB | | | |
| AULD-TG Series Maximum voltage: 36V Maximum current: 5A |  |  | / | 8mm 0.31" | 30-120 LEDs/M 9-36LEDs/ft | AULD-TG-N8BB-2 AULD-TG-N8XB-2 |
| | | | | 10mm 0.39" | 30-120 LEDs/M 9-36LEDs/ft | AULD-TG-N10BB-2 AULD-TG-N10XB-2 |

RGB/ IP65

| Series | Product | | | PCB Width | LED QTY | Product NO. |
|---|---|---|----------------------------|---------------|------------------------------|------------------------------------|
| | BB PCB to PCB | XB Cable to PCB | BXB PCB to Cable to PCB | | | |
| AULD-TG Series Maximum voltage: 36V Maximum current: 5A |  |  | / | 10mm 0.39" | 30-120 LEDs/M 9-36LEDs/ft | AULD-TG-N10BB-4 AULD-TG-N10XB-4 |









Clips / IP20

| LD-KZ Product | PCB Width | Product NO. |
|---|------------|--------------|
|  | 8mm 0.31" | AULD-KZ-8DJ |
|  | 8mm 0.31" | AULD-KZ-8LB |
|  | 10mm 0.39" | AULD-KZ-10DJ |
|  | 10mm 0.39" | AULD-KZ-10LB |
|  | 10mm 0.39" | AULD-KZ-12LB |

Cable Fast Connector / IP20

| Product | Product NO. |
|---|----------------|
|  | AULD-XC-JXD-D2 |
|  | AULD-XC-JXD-H2 |
|  | AULD-XC-JXD-T2 |

PCB corner Connector / IP20

| FPC Product | PCB Width | Product NO. |
|---|------------|------------------|
|  | 8mm 0.31" | AULD-FPC-8SMD-L |
|  | 8mm 0.31" | AULD-FPC-8SMD-T |
|  | 8mm 0.31" | AULD-FPC-8SMD-X |
|  | 10mm 0.39" | AULD-FPC-10SMD-L |
|  | 10mm 0.39" | AULD-FPC-10SMD-T |
|  | 10mm 0.39" | AULD-FPC-10SMD-X |
|  | 10mm 0.39" | AULD-FPC-10RGB-L |
|  | 10mm 0.39" | AULD-FPC-10RGB-T |
|  | 10mm 0.39" | AULD-FPC-10RGB-X |

ALUMINUM PROFILE LIST



AL6063 material have
good heat dissipation



Vavious sizes for optional,
To meet the needs of different
installation site



Surface oxidation treatment for
corrosion resistance



Surface color is customizable





AULD-2020

High Quality Aluminum Profiles for commercial and residential LED strip lighting applications. Suitable for recessed installation in window, in-ceiling or in-wall accent decor lighting.

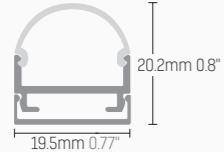

ALUMINUM PROFILE LIST

| Product NO. | Section diagram (mm) | Strip Width | Recommended LED QTY | Accessories | Cover |
|-------------|---|----------------------|-----------------------|---|---------------------------|
| AULD-2020 |  | 8-15mm 0.31-0.59" | ≥120 LEDs/m 36LEDs/ft |  | PC transparent PC opal |



ALUMINUM PROFILE LIST

AULD-1013

Slim Aluminum profile is suitable for all concealed lighting applications including under-cabinet lighting, display case lighting, restaurant & bar lighting etc.

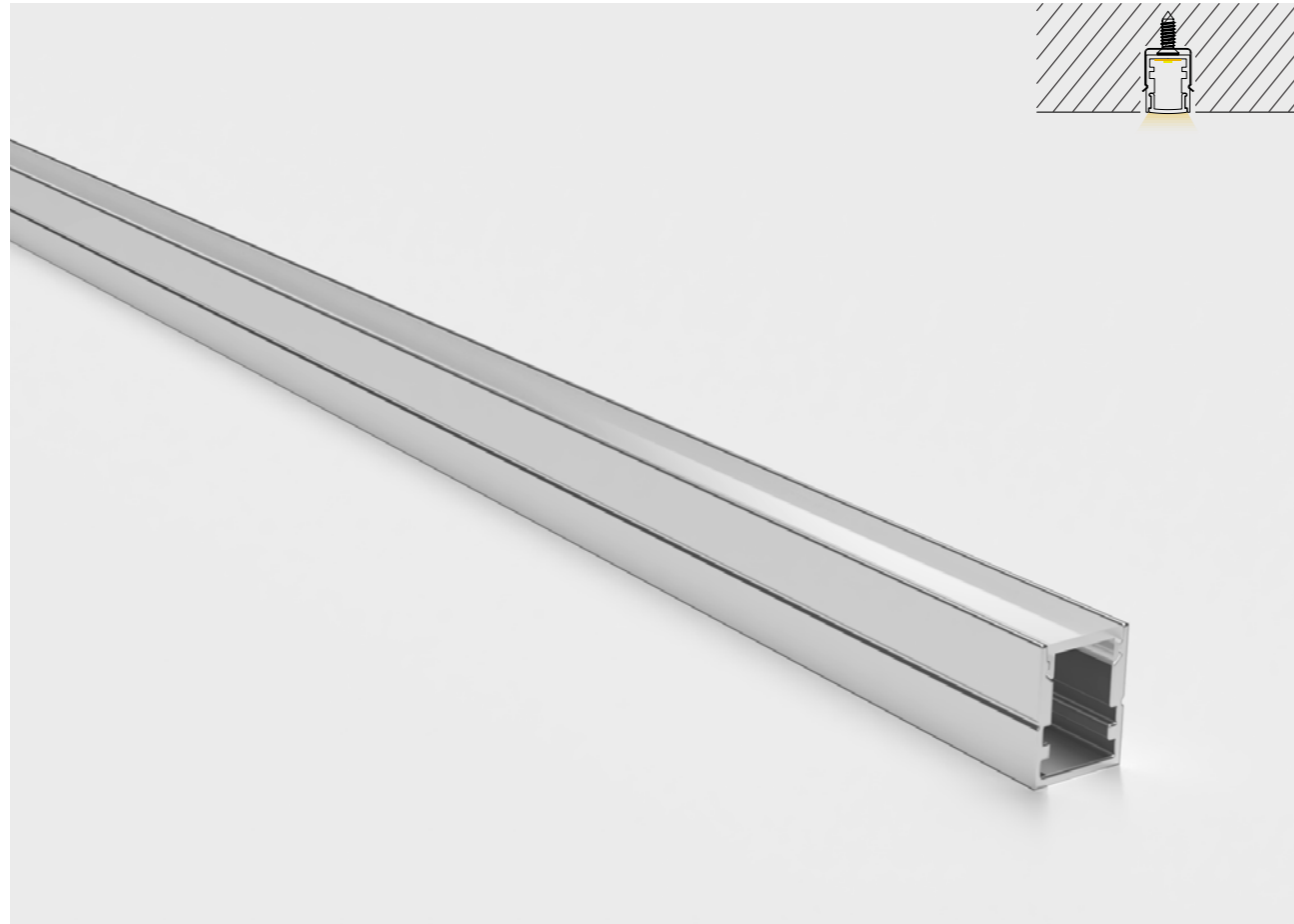

ALUMINUM PROFILE LIST

| Product NO. | Section diagram (mm) | Strip Width | Recommende LED QTY | Cover |
|-------------|----------------------|----------------------|--------------------------------------|---------------------------|
| AULD-1013 | | 6-8mm 0.31"-0.24" | ≥ 120 LEDs ≥ 37 LEDs/ft | PC transparent PC opal |
| Accessories | | | | |

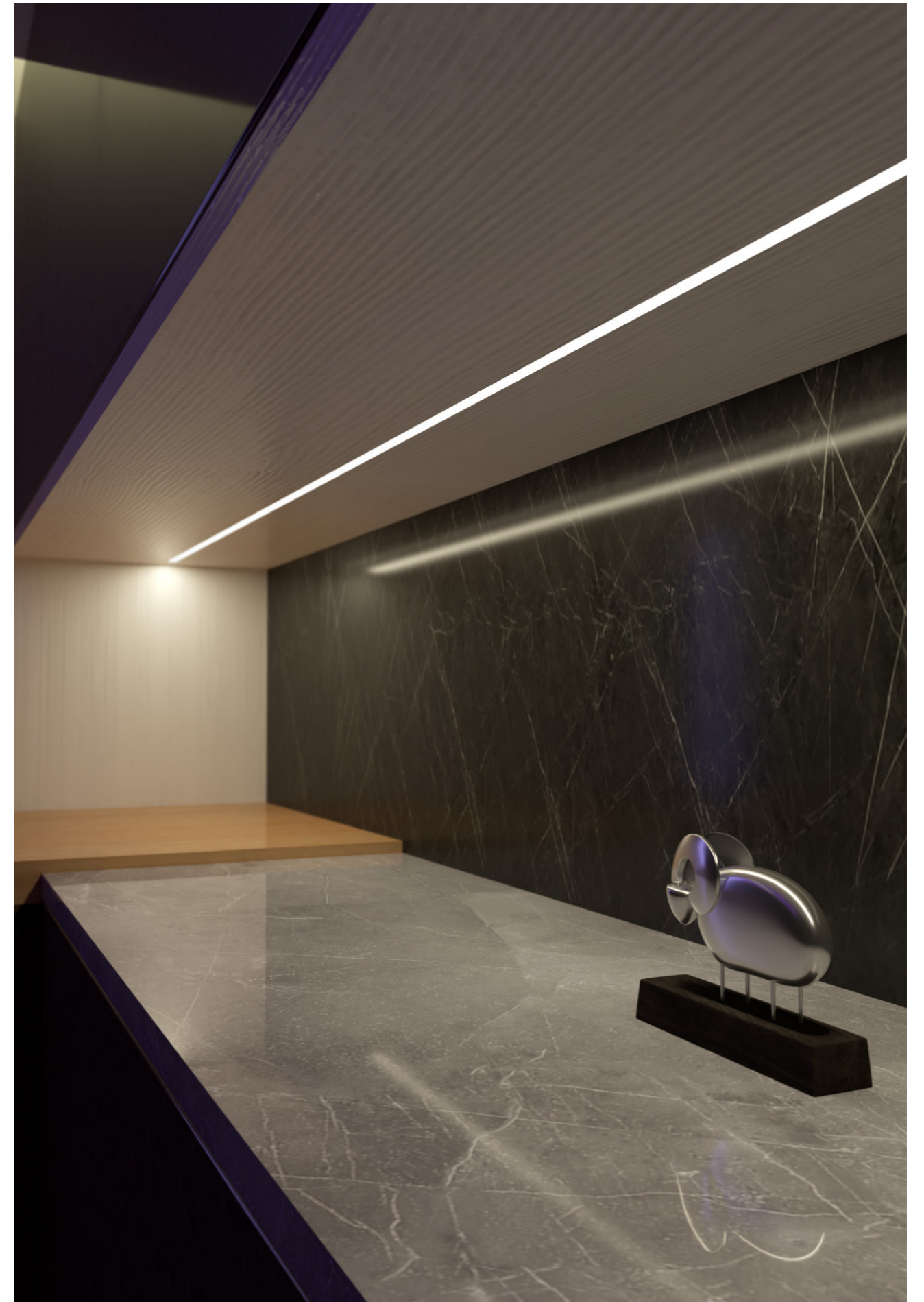

ALUMINUM PROFILE LIST

AULD-1616

Slim Aluminum Profile for 90° Corner Mounting. It can be mounted in pre-made slots of Woodworking and drywall structures. It's suitable for all concealed lighting applications including joinery lighting, cove lighting, under-cabinet lighting, display case lighting, restaurant & bar lighting, residential strip-lighting etc.

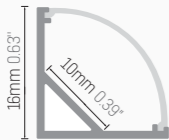
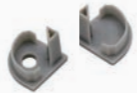

ALUMINUM PROFILE LIST

| Product NO. | Section diagram (mm) | Strip Width | Recommended LED QTY | Accessories | Cover |
|-------------|---|-----------------------|--------------------------|---|---------------------------|
| AULD-1616 |  | 8-10mm 0.31"-0.39" | ≥ 120LEDs ≥ 37LEDs/ft |  | PC transparent PC opal |

Accessories



Cover

Clips



ALUMINUM PROFILE LIST

AULD2415

Aluminum profiles with wings to conceal the groove. And 14.5mm deep light emitting distance to offer soft light output with light dot free.

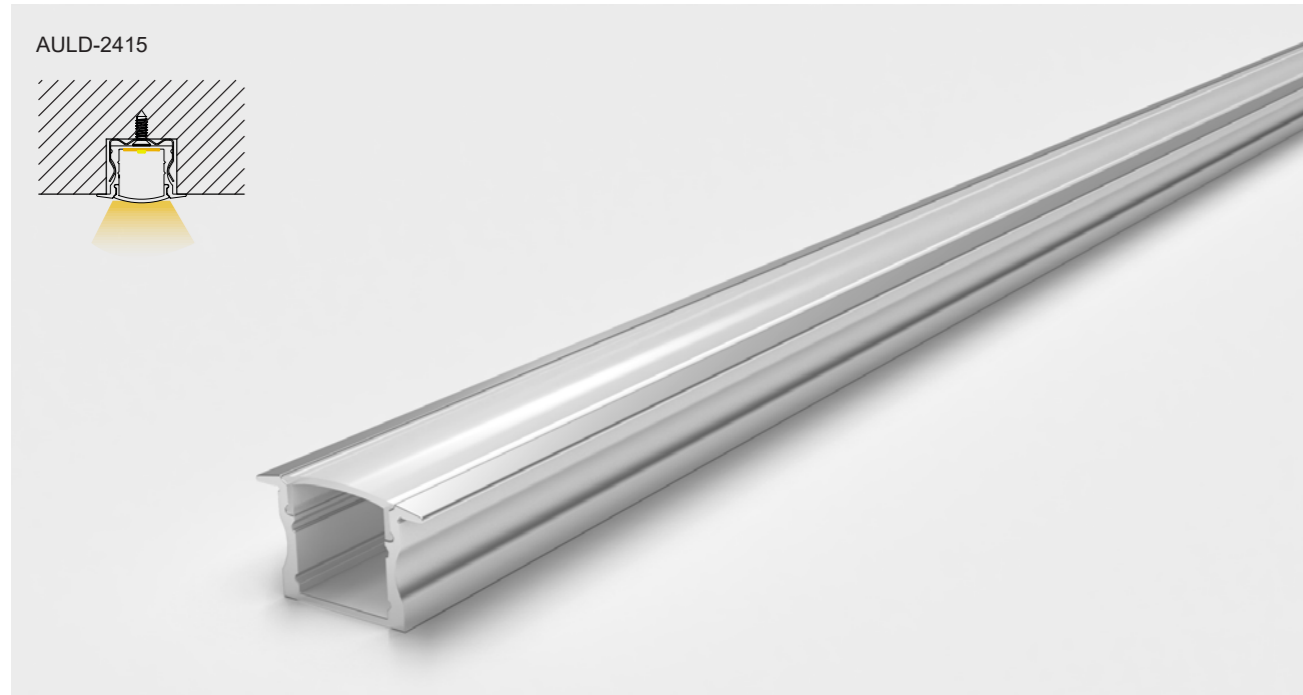

ALUMINUM PROFILE LIST

| Product NO. | Section diagram (mm) | Strip Width | Recommende LED QTY | Accessories | Cover |
|-------------|----------------------|-----------------------|-------------------------|-------------|---------------------------|
| AULD-2415 | | 8-12mm 0.31"-0.47" | ≥ 96LEDs ≥ 29LEDs/ft | | PC transparent PC opal |

Accessories



ALUMINUM PROFILE LIST

AULD-1708 / AULD-1715

High Quality Aluminum Profile for commercial and residential LED strip lighting applications. It's suitable for recessed installation in window, in-ceiling or in-wall accent decor lighting, under-cabinet lighting, display case lighting, restaurant & bar lighting, etc.

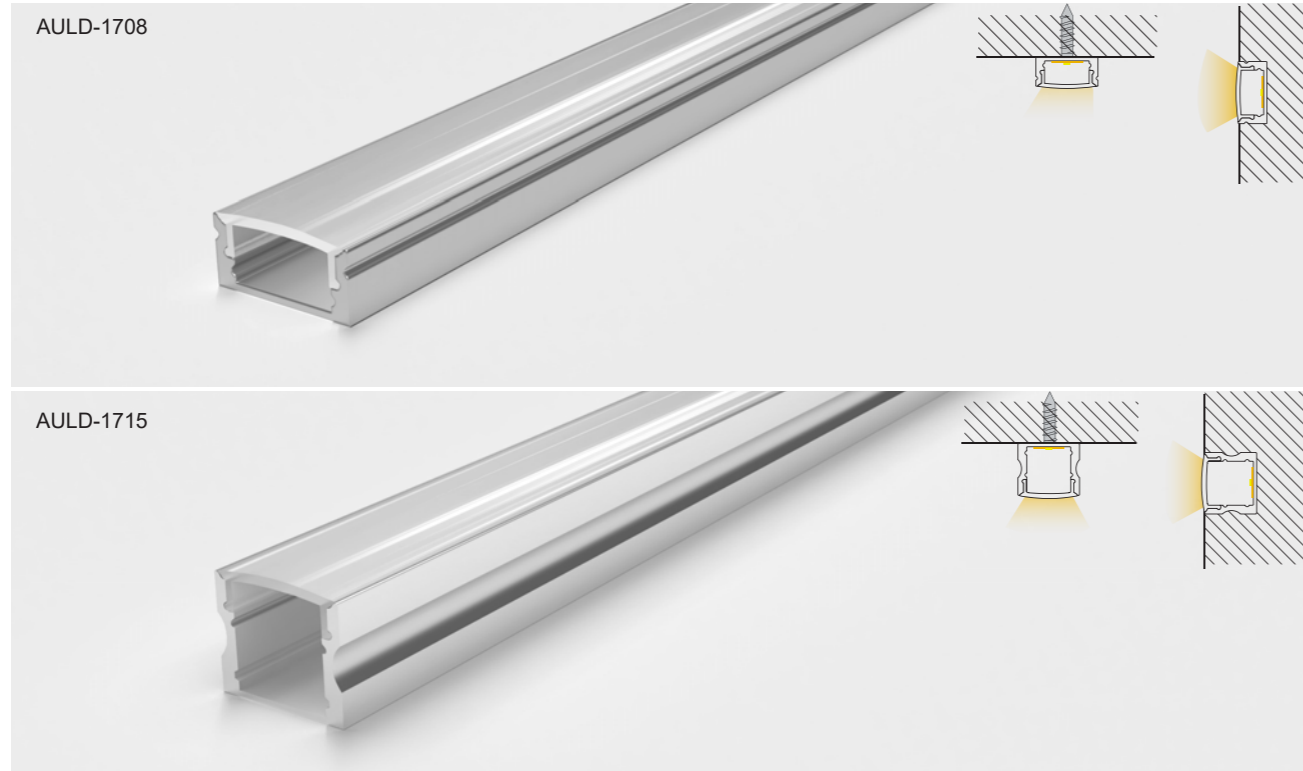

ALUMINUM PROFILE LIST

| Product NO. | Section diagram (mm) | Strip Width | Recommended LED QTY | Accessories | Cover |
|-------------|---|-----------------------|--------------------------|---|---------------------------|
| AULD-1708 |  | 8-12mm 0.31"-0.47" | ≥ 240LEDs ≥ 73LEDs/ft |  | PC transparent PC opal |
| AULD-1715 |  | 8-12mm 0.31"-0.47" | ≥ 96LEDs ≥ 29LEDs/ft |  | PC transparent PC opal |

Accessories



ALUMINUM PROFILE LIST

AULD-3020

High Quality Aluminum Profile for commercial and residential LED strip lighting applications. It's suitable for recessed installation in window, in-ceiling or in-wall accent decor lighting, under-cabinet lighting, display case lighting, restaurant & bar lighting, etc.

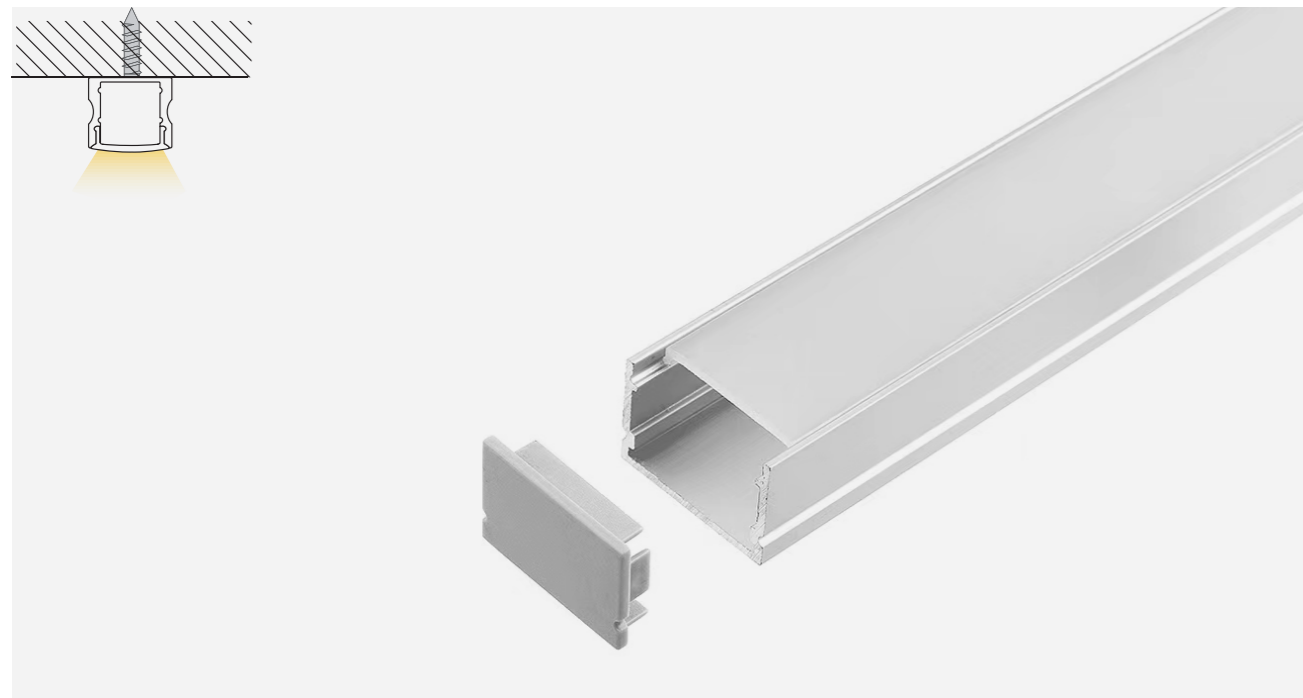

ALUMINUM PROFILE LIST

| Product NO. | Section diagram (mm) | Strip Width | Recommenede LED QTY | Cover |
|-------------|----------------------|-----------------------|---|---------------------------|
| AULD-3020 | | 8-27mm 0.31"-1.06" | $\geq 96\text{LEDs/m}$ $\geq 29\text{LEDs/ft}$ | PC transparent PC opal |

Accessories

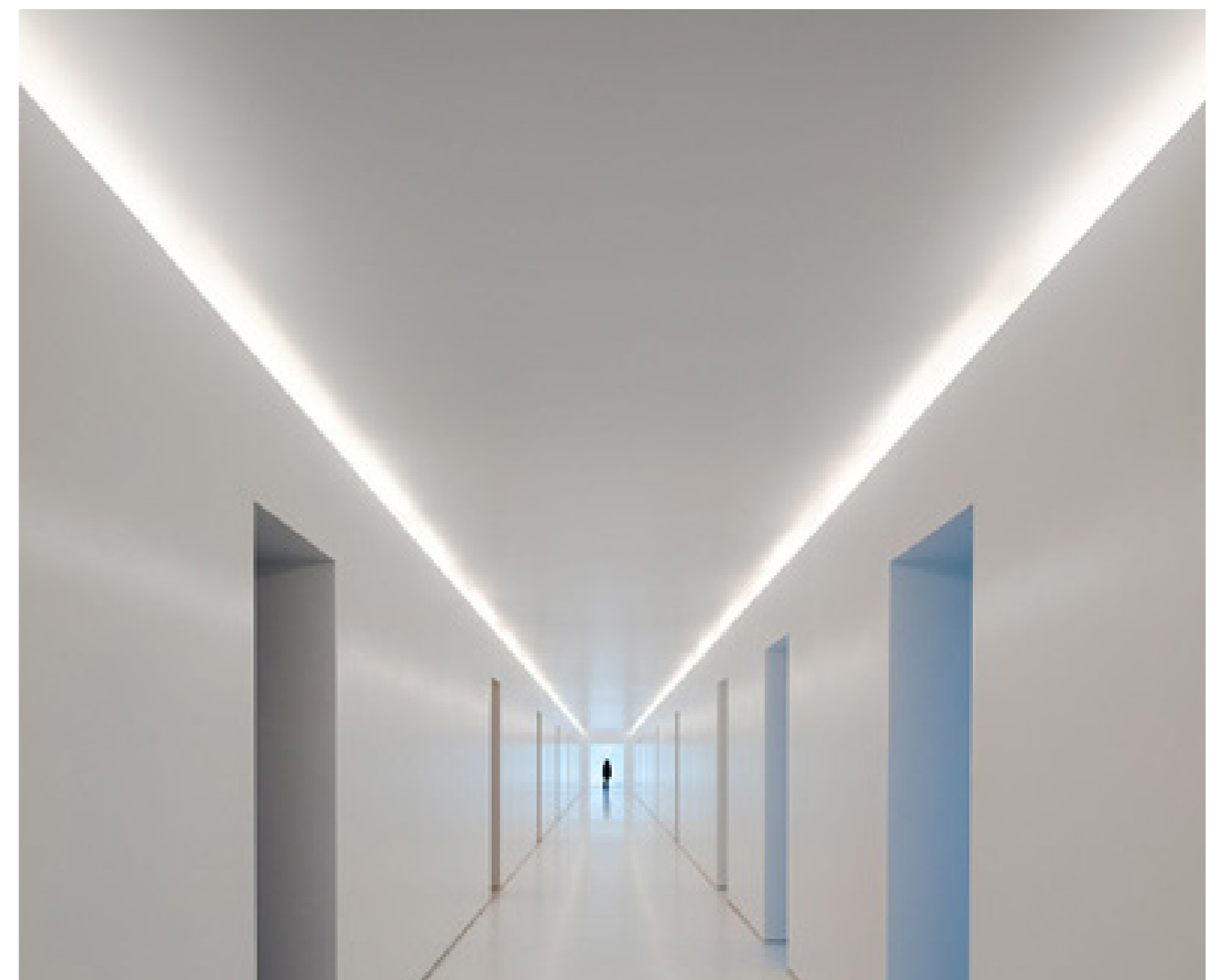

ALUMINUM PROFILE LIST

AULD-1207

High Quality Aluminum Profile for commercial and residential LED strip lighting applications. It's suitable for recessed installation in window, in-ceiling or in-wall accent decor lighting, under-cabinet lighting, display case lighting, restaurant & bar lighting, etc.

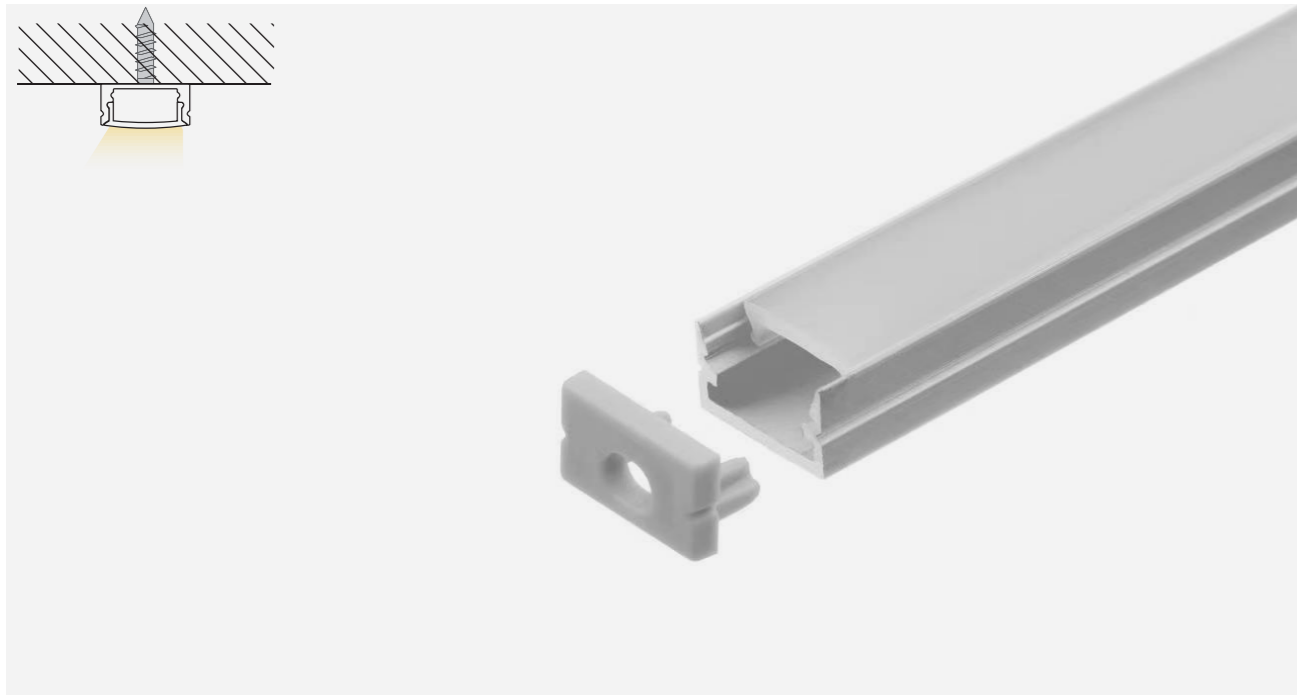

ALUMINUM PROFILE LIST

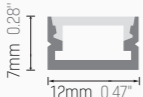
| Product NO. | Section diagram (mm) | Strip Width | Recommenede LED QTY | Cover |
|-------------|---|-----------------------|----------------------------|---------------------------|
| AULD-1207 |  | 6-10mm 0.24"-0.39" | ≥ 120LEDs/m ≥ 59LEDs/ft | PC transparent PC opal |

Accessories

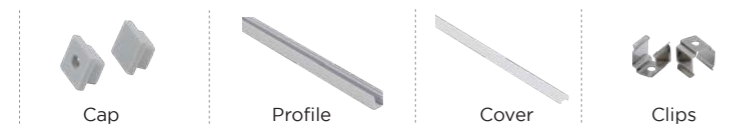

Cap

Profile

Cover



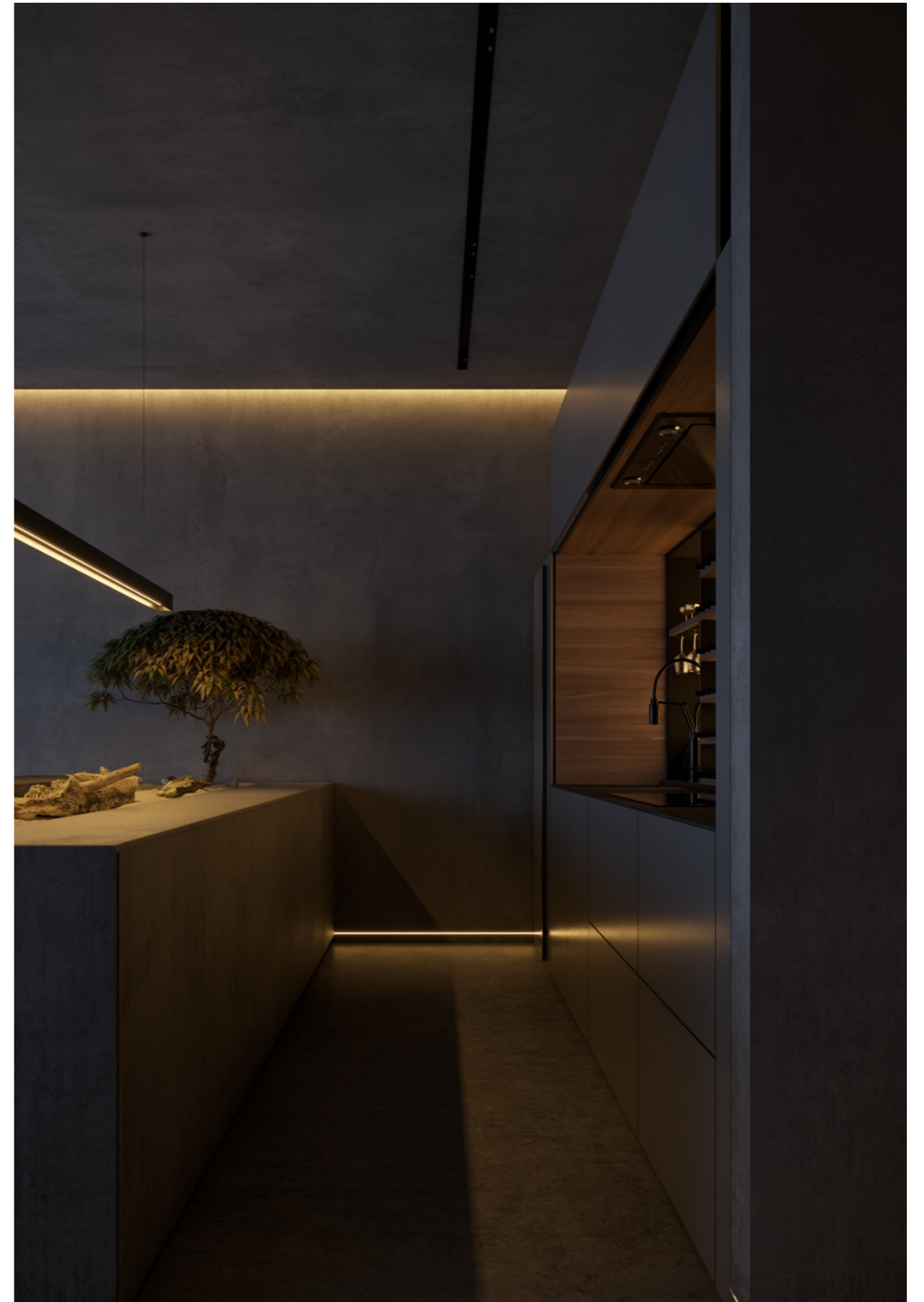



Clips





ALUMINUM PROFILE LIST

CONTROLLERS

DMX512





| Product NO. | Product | Input Volt | Output volt | Output | Applicable | Suitable for |
|--|--|--------------|-------------|---|-------------------------------------|-----------------|
| ACTE480-24-DMX-P0-G1-CN-12/24V-PC-D4LU |  (Use with DMX512 controller) | DC12-24V | DC12-24V | DC12V:300W DC24V:480W Max. 480W | Single color Tunable RGB RGBW | Strips/fixtures |
| ACTE512-24-DMX-P0-G1-CN-110/240-PC-T111U |  | AC110-240VAC | / | Single color DMX512 Wall-mount control pad | Single color | DMX512 |
| ACTE120-24-DMX-P0-G1-CN-110/240-PC-T141U |  | AC110-240VAC | / | RGBW DMX512 Wall-mount control pad | RGBW | DMX512 |
| ACTE102-24-DMX-P0-G1-CN-110/240-PC-T151U |  | AC110-240VAC | / | RGBW DMX512 Wall-mount control pad | RGB+CCT | DMX512 |
| ACTE720-24-DMX-P0-G1-CN-12/36V-PC-02PU |  | DC12-36V | DC12-36V | DC12V:240W DC24V:480W DC36V:720W | CCT Tunable white RGB RGBW | DMX512 |
| ACTE720-24-DMX-P7-G1-CN-12/36V-PC-02B(WP)U |  | DC12-36V | DC12-36V | DC12V:240W DC24V:480W DC36V:720W | CCT Tunable white RGB RGBW | DMX512 |

SPI Controller

| Product NO. | Product | Input Volt | Output volt | Output | Applicable | Suitable for |
|---------------------------------------|---|------------|-------------|----------------------|----------------|--|
| ACTE2048-24-SPI-P0-G1-CN-24-PCU |  | DC5-24V | DC524V | 20m (2048 pixels) | APP | SPI strips WS2813 P943F SK6812 SK6815 etc. |
| ACTE2048-24-SPI-P0-G1-CN-24-PCU |  | DC5-24V | DC524V | 20m (2048 pixels) | APP | SPI strips WS2813,P943F SK6812 SK6815 etc. with music function |
| ACTE2048-24-SPI-P0-G1-CN-24-PC-SPI16U |  | DC5-24V | DC524V | 20m (2048 pixels) | Remote control | SPI strips |

2.4G Remote Controller

Use with remote controller

| Product NO. | Product | Input Volt | Output volt | Output | Applicable | Suitable for |
|---|---|------------|---------------|--|-------------------------------------|-----------------|
| AUCTE648-36-RF-P0-G1-CN-12/36V-PC-V3L |  | DC12-36V | DC12-36V | DC12V:216W DC24V:432W DC36V:648W 3CH*6A | Single color tunable RGB | Strips/fixtures |
| AUCTE240-24-RF-P0-G1-CN-12/24V-AL |  | DC12-24V | DC12-24V | DC12V: 3CH*72W DC24V: 3CH*144W Max.current <10A | RGB | |
| AUCTE240-24-RF-P0-G1-CN-12/24V-PC |  | DC12-24V | DC12-24V | DC12V: 3CH*72W DC24V: 3CH*144W Max.current <10A | RGBW | |
| ACTE720-36-RF-P0-G1-CN-12/36V-PC-9PU |  | DC12-36V | 4CH, 5A/CH | DC12V:240W DC24V:480W DC36V:720W | CCT Tunable white RGB RGBW | |
| ACTE720-36-RF-P7-G1-CN-12/36V-PC-9FA(WP)U |  IP67 | DC12-36V | 4CH, 5A/CH | DC12V:240W DC24V:480W DC36V:720W | CCT Tunable white RGB RGBW | |

Dali Controller



| Product NO. | Product | Input Volt | Output volt | Output | Applicable | Suitable for |
|--|---|-----------------------------|------------------------------|---------------------------------|--------------------------------|-----------------|
| AUCTE240-24-D-P0-G1-CN-12/24V-PC-DA03S |  | DC12-36V wide input voltage | DC12-36V wide output voltage | DC12V:96W DC24V:192W 1*8A | Single color DT8,TC PUSH | Strips/fixtures |

0-10V Controller

| Product NO. | Product | Input Volt | Output volt | Output | Applicable | Suitable for |
|---------------------------------------|---|-----------------------------|-------------|----------------------------------|--------------|-----------------|
| AUCTE432-36-D-P0-G1-CN-12/36V-PC-2001 |  | DC12-36V wide input voltage | DC0-10V | 12V<144W 24V<288W 36V<432W | Single color | Strips/fixtures |



Amplifier

Use with DMX512 Decoder or Synchronous changing RGB controllers

| Product NO. | Product | Input Volt | Output volt | Output | Applicable | Suitable for |
|---------------------------------------|---|------------|-------------|--|--|-----------------|
| AUCTE576-36-D-P0-G1-CN-12/36V-PC-EV2 |  | DC12-36V | DC12-36V | DC12V:192W DC24V:384W DC36V:576W 2CH*8A | Tunable | Strips/fixtures |
| AUCTE648-36-D-P0-G1-CN-12/36V-PC-EV3H |  | DC12-36V | DC12-36V | DC12V:216W DC24V:432W DC36V:648W 3CH*6A | Single color tunable RGB | |
| AUCTE720-36-D-P0-G1-CN-12/36V-PC-EV4 |  | DC12-36V | DC12-36V | DC12V:240W DC24V:480W DC36V:720W 4CH*5A | Single color tunable RGB RGBW | |

Remote Control







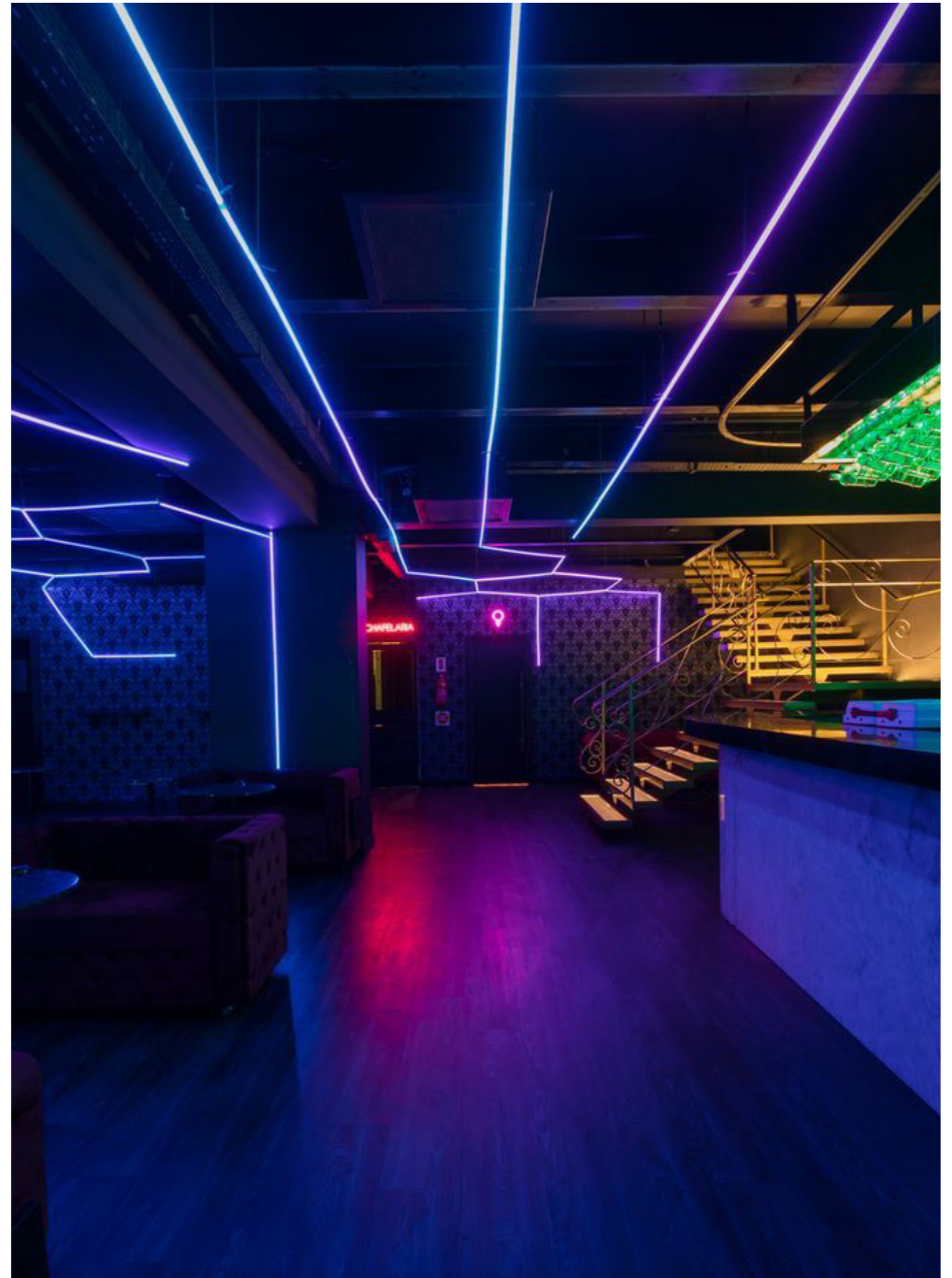









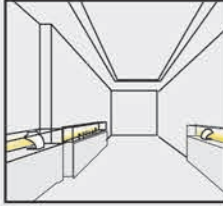





Use with the signal receiver







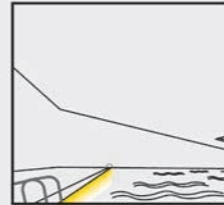
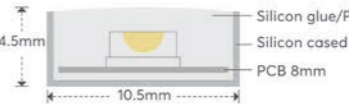

| Product NO. | Product | Output | Applicable |
|---------------------------------|---|--------------|--------------------|
| AUCTE4-3-D-P0-G1-CN-3V-PC-R7 |  | 2*7# battery | Tunable |
| AUCTE1-3-D-P0-G1-CN-3V-PC-RT4 |  | 2*7# battery | RGB/RGBW 1 zone |
| AUCTE1-3-D-P0-G1-CN-6V-PC-RF1 |  | 2*7# battery | CCT |
| AUCTE1-3-D-P0-G1-CN-4.5V-PC-RF3 |  | 2*7# battery | RGB |

| Product NO. | Product | Output | Applicable |
|---------------------------------|---|--------------|---------------------------|
| AUCTE4-3-D-P0-G1-CN-3V-PC-RT9 |  | 2*7# battery | RGB/RGBW 4 zone |
| AUCTE1-3-D-P0-G1-CN-3V-PC-RT5 |  | 2*7# battery | RGB/ RGB+CCT 1 zone |
| AUCTE1-3-D-P0-G1-CN-3.7V-PC-RF2 |  | 2*7# battery | RGBW 4 zone |

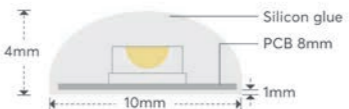
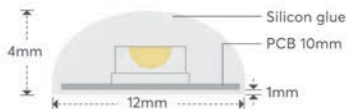
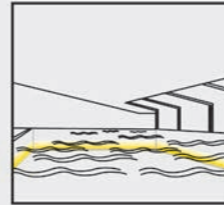

IP RATING

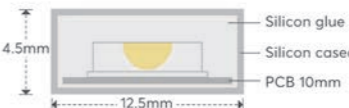
| | |
|---|---|
| IP20 Ribbon Series  | 2835 SMD   |
| | 5050 SMD   |
| | 2110 SMD   |
| IP62  | 2835 SMD Dropper Series   |
| | 5050 SMD Dropper Series   |
| | 2835 SMD Hollow Extrusion   |
| IP65  | 2835 SMD Tube Series   |
| | 5050 SMD Tube series   |
| | 2835 SMD Hollow Extrusion   |
| 5050 SMD Hollow Extrusion   | |

| | |
|--|---|
| IP67  | 2835 SMD Crystal series   |
| | 2835 SMD Solid Extrusion (Square)   |
| | 2835 SMD Solid Extrusion (Curve)   |
| IP68  | 2835 SMD Jade series   |
| | 5050 SMD Jade series   |

Tolerance $\pm 0.3\text{mm}$

NAMING GUIDANCE

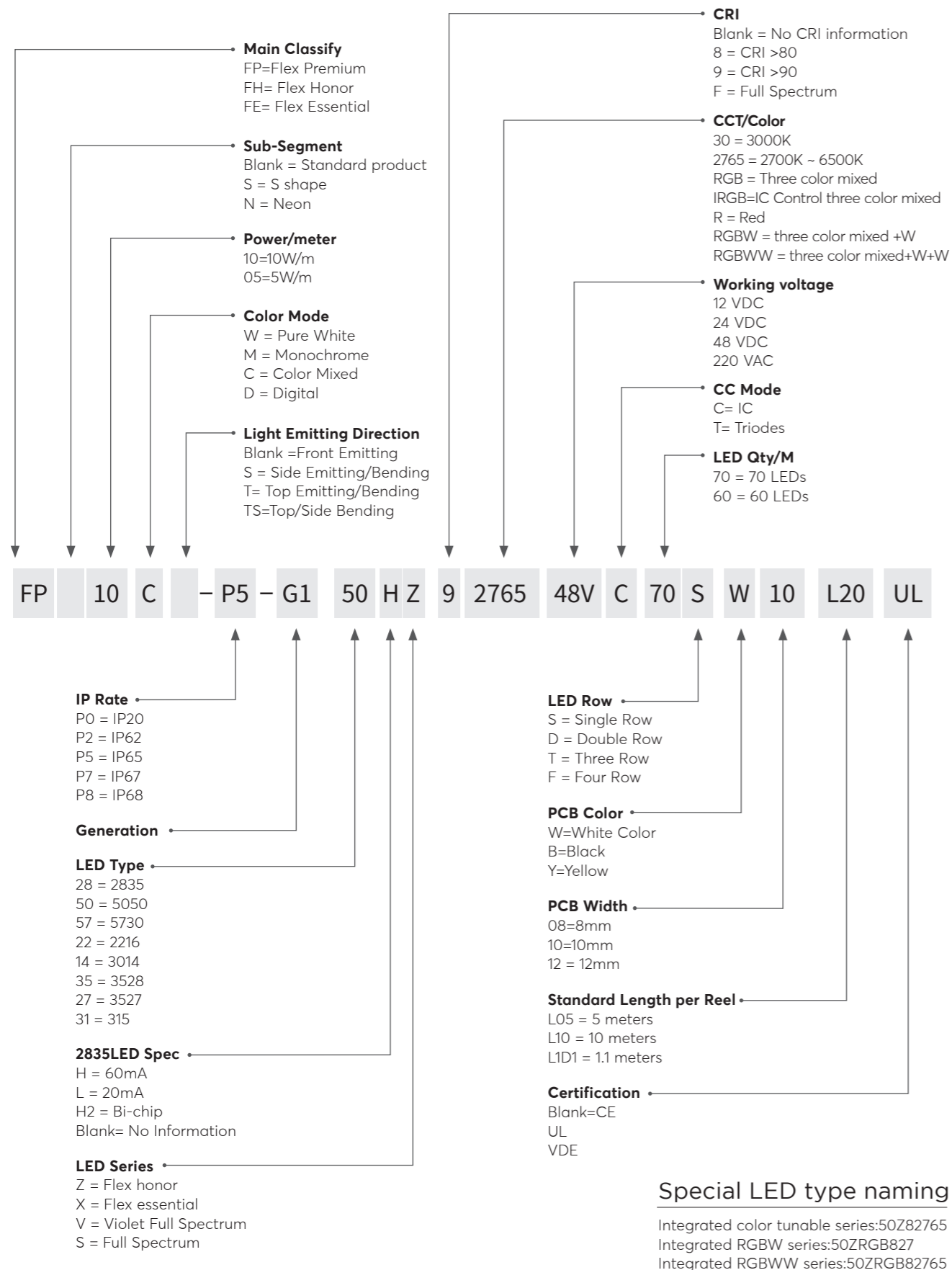

GUS Enterprise Co., Ltd.

52/39 Sutthisan Winitchai Rd.
Samsen Nai Sub-district hayathai District, Bangkok 10400

Tel: +66(61)5455-978 E-mail: sales9.gus@gmail.com



www.auralighting-th.com